

Air-Cooled Scroll Chiller

(R410A)

5BHW0-01H(Replaces 5BHW0-01G)

LG

TOTAL HVAC

SOLUTION

PROVIDER

ENGINEERING PRODUCT DATA BOOK



LG participates in the ECP programme for EUROVENT VRF program.
Check ongoing validity of certification : www.eurovent-certification.com



P/No. : MFL67285208

Air-Cooled Scroll Chiller (R410A)

- 1. Nomenclature**
- 2. Selection Procedure**
- 3. Specifications**
- 4. Performance Data of Cooling**
- 5. Performance Data of Heating**
- 6. Head loss of Cold water**
- 7. Dimensions**
- 8. Base of Installation**
- 9. Electric Characteristics**
- 10. Wiring Diagrams**
- 11. Installation of Chiller**
- 12. Specification of Production**
- 13. Appendix**

Air-Cooled Scroll Chiller (R410A)

1. Nomenclature

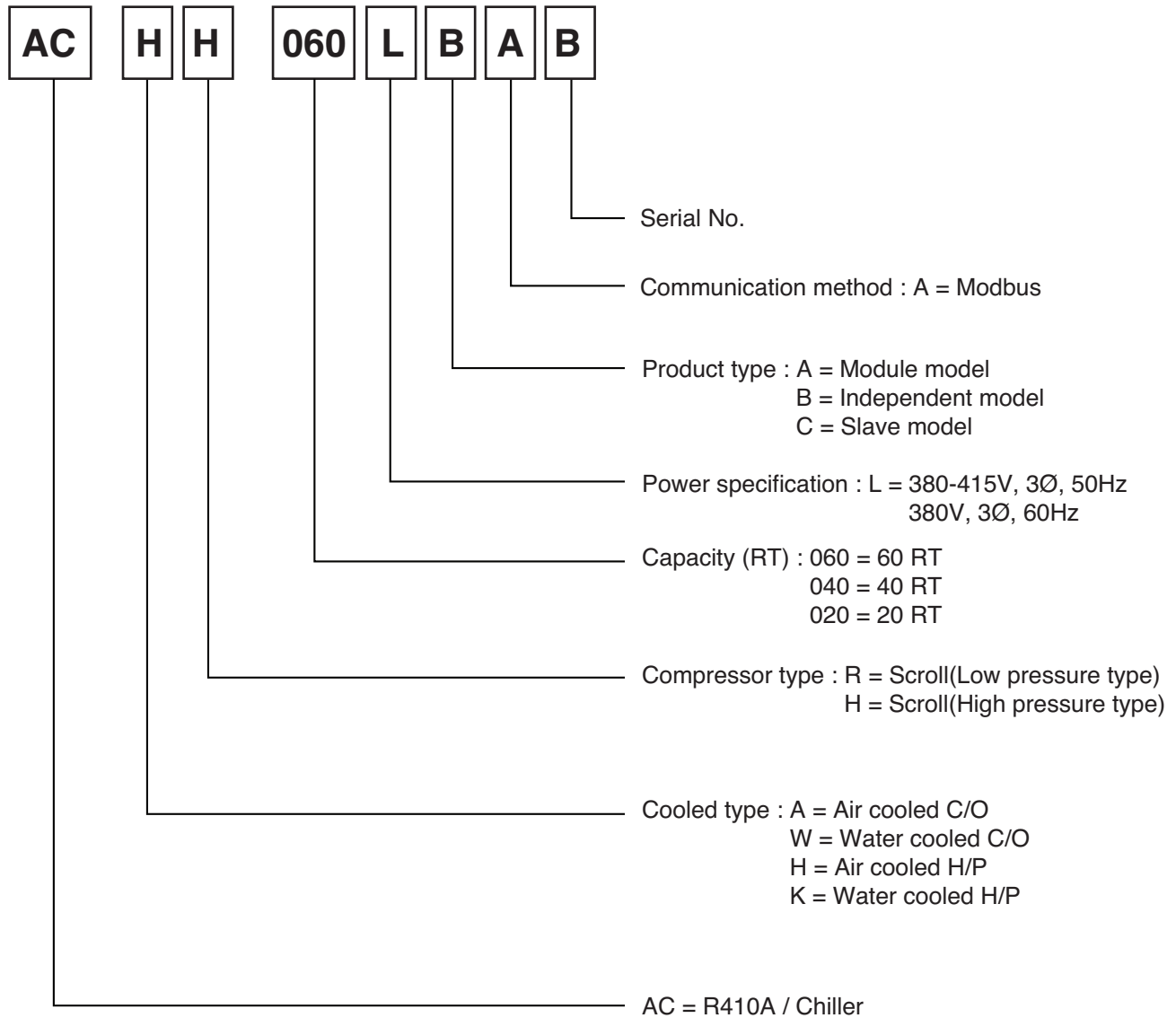

2. Selection Procedure

■ Selection guide

The product information required in various requirements is written in detail from Chapter 6.

If you need a product for special system application or product with the condition outside this PDB, please get consultation from nearby sales office or specialty store.

■ Selection procedure

1. Check usage condition

Before selecting the model, the following usage conditions must be decided.

- Cold and hot water in/out temperature and outdoor temperature
- Cold and hot water flow amount

(flow amount can be calculated if you know the freezing load and chilled water in/out temperature.)

2. Selecting candidate model

Required rated capability is selected through load calculation, and you can select the corresponding model by looking at Chapter 8 Cooling/heating capability change table.

When you select the candidate model, do not select a model with less volume than the required rated capability, but select a model with the same or bigger volume.

3. Performance adjustment for fouling

The data in this technical data manual is based on chilled water fouling coefficient of 0.000018 m²C/W.

4. Performance adjustment after adding freeze and burst prevention solution

If cooling operation is performed in Winter, or if water inside the cycle is not removed in the resting phase, you have to add freeze and burst prevention solution to protect from freeze and burst.

Freezer characteristics change by adding freeze and burst prevention solution, so it should be adjusted.

Refer to the following table for the adjustment coefficient after adding freeze and burst prevention solution.

Antifreeze Type	Item	Antifreeze % by wt				
		10 %	20 %	30 %	40 %	50 %
Methanol	Cooling	0.998	0.997	0.995	0.993	0.992
	Heating	0.995	0.990	0.985	0.979	0.974
	Pressure Drop	1.023	1.057	1.091	1.122	1.160
Ethylene glycol	Cooling	0.996	0.991	0.987	0.983	0.979
	Heating	0.993	0.985	0.977	0.969	0.961
	Pressure Drop	1.024	1.068	1.124	1.188	1.263
Propylene glycol	Cooling	0.993	0.987	0.980	0.974	0.968
	Heating	0.966	0.973	0.960	0.948	0.935
	Pressure Drop	1.040	1.098	1.174	1.273	1.405

2. Selection Procedure

5. Finalizing the model

As a result of verifying product performance and power consumption considering various adjustment coefficients for the candidate models, if there is no problem, you can finalize it as the final model.

If there is a problem, review again from the candidate model selection stage.

Determine inverter scroll chiller unit size and operating conditions required to meet given capacity at given conditions.

Step I

Given

Capacity : 115 kW

Leaving chilled water Temp : 7 °C

Cooler Water Temp different : 5 °C

Condenser Entering Ari temp : 35 °C

Fouling Factor : 0.018

Note: For other than approximately 6 to 8 °C temperature difference, unit selection must be made using the selection software.(LATS ISC). and contact LG consultant.

Step II

From chiller ratings table on page 7 to 24 and pressure drop curves on page 25, determine operating data for selected unit.

Unit : ACAH040LBAA

Capacity : 123 kW X fouling factor coefficient(1.0) = 123 kW (see 100% capacity table)

Power input : 46.4 kW X fouling factor coefficient(1.0) = 46.4 kW

Cooling water flow : 353 LPM

Pressure drop : 34 kPa

Note: If the chiller load is larger than the demand capacity, Check the partial load capacity table.

Step III

Review if the calculated specification is suitable for the site.

Air-Cooled Scroll Chiller (R410A)

3. Specifications

■ Heat Pump

Inverter Scroll Chiller		Model	ACHH020LBAB	ACHH023LBAB	ACHH033LBAB
Power		Phase,Lines,V	3,4,380~415	3,4,380~415	3,4,380~415
Capacity	Cooling	kW	65.0	74.0	114.0
		RT	18.5	21.0	32.4.0
	Heating	kW	70.3	82.0	120.0
		RT	20	23	34
Input Power	Cooling	kW	22.2	27.4	36.8
	Heating	kW	21.6	27.3	35.3
Max operating	Current	A	39	48	72
Efficiency	Cooling	W/W	2.93	2.70	3.10
	Heating	W/W	3.25	3.00	3.40
SEER		W/W	4.40	4.20	4.50
SCOP		W/W	3.30	3.30	3.30
Sound Pressure		dB(A)	67	68	68
Sound Power	Cooling	dB(A)	86	87	87
	Heating	dB(A)	86	87	88
Compressor	Type	-	Scroll	Scroll	Scroll
	No. of Compressor	EA	2	2	4
	Oil Type	-	PVE	PVE	PVE
	Oil charge	cc	1,400 × 2	1,400 × 2	1,400 × 4
Refrigerant	Type	-	R410A	R410A	R410A
	Amount of Charged	kg	7.0 × 2	7.0 × 2	7.0 × 4
	GWP	-	2087.5	2087.5	2087.5
	t-CO ₂ eq	-	29.23	29.23	58.45
Evaporator	Type	-	plate	plate	plate
	Pressure drop	kPa	21.5	28.7	18.7
	Operating Maximum pressure (Refrigerant / Water)	kg/cm ²	42/10	42/10	42/10
	Water Flow Rate_Standard(Cooling/Heating)	LPM	186/200	211/235	327/345
	Cold Water Flow Rate (Min. / Max.)	LPM	130/242	148/274	229/425
	Inlet/Outlet diameter(Water pipe)	mm	50A/50A	50A/50A	65A/65A
Fan motor	Type	-	BLDC	BLDC	BLDC
	No. of Fan	EA	2	2	4
	No. of Vanes	EA	4	4	4
	Air Flow Rate	CMM	210 × 2 @1,000 rpm	210 × 2 @1,000 rpm	210 × 4 @1,000 rpm
	Motor power	W	900 × 2	900 × 2	900 × 4
Expansion unit		-	EEV	EEV	EEV
Weight		kg	520	520	970
Dimension	W	mm	765	765	1528
	H	mm	2293	2293	2293
	D	mm	2154	2154	2154
Footprint		m ² /RT	0.089	0.078	0.102
Protection	High/Low Pressure	-	○	○	○
Devices	Anti Frost	-	○	○	○
Remote Control		-	Modbus	Modbus	Modbus
Power	Power Line	mm ² × C	25 × 5	25 × 5	50 × 5
Outlet	Cooling	°C	4~20	4~20	4~20
Temperature	Heating	°C	30~55	30~55	30~55
Ambient	Cooling	°C	-15~48	-15~48	-15~48
Temperature	Heating	°C	-30~35	-30~35	-30~35
Earth Leakage Breaker		A	60	60	125
Guaranteed Load Capacity Range		-	20% ~ 100%		

Notes:

1. Due to our policy of innovation some specifications may be changed without prior notification.
2. Capacities and Inputs are based on the following conditions
Cooling : Outdoor air temp. 35°C, Water inlet temp. 12°C, Water Outlet temp. 7°C
Heating : Outdoor air temp. 7°C, Water inlet temp. 40°C, Water Outlet temp. 45°C

3. Sound pressure level is measured on the rated condition in the anechoic rooms by ISO 3745 standard.
Sound power level is measured ISO 9614:2009 by sound intensity method.
Therefore, these values can be increased owing to ambient conditions during operation.

Air-Cooled Scroll Chiller (R410A)

3. Specifications

Inverter Scroll Chiller		Model	ACHH040LBAB	ACHH045LBAB	ACHH050LBAB
Power		Phase,Lines,V	3,4,380~415	3,4,380~415	3,4,380~415
Capacity	Cooling	kW	130.0	148.0	171.0
		RT	37.0	42.1	48.6
	Heating	kW	140.6	164.0	180.0
		RT	40	47	51
Input Power	Cooling	kW	44.4	54.8	55.2
	Heating	kW	43.3	54.7	52.9
Max operating Current		A	78	96	108
Efficiency	Cooling	W/W	2.93	2.7	3.1
	Heating	W/W	3.25	3.00	3.4
SEER		W/W	4.40	4.20	4.50
SCOP		W/W	3.30	3.30	3.30
Sound Pressure		dB(A)	68	68	68
Sound Power	Cooling	dB(A)	90	91	88
	Heating	dB(A)	90	92	88
Compressor	Type	-	Scroll	Scroll	Scroll
	No. of Compressor	EA	4	4	6
	Oil Type	-	PVE	PVE	PVE
	Oil charge	cc	1,400 × 4	1,400 × 4	1,400 × 6
Refrigerant	Type	-	R410A	R410A	R410A
	Amount of Charged	kg	7.0 X 4	7.0 X 4	7.0 X 6
	GWP	-	2,087.5	2,087.5	2,087.5
	t-CO ₂ eq	-	58.45	58.45	87.68
Evaporator	Type	-	plate	plate	plate
	Pressure drop	kPa	21.5	28.7	18.7
	Operating Maximum pressure (Refrigerant / Water)	kg/cm ²	42 / 10	42 / 10	42 / 10
	Water Flow Rate_ Standard(Cooling/Heating)	LPM	372/400	411/470	490/518
	Cold Water Flow Rate (Min. / Max.)	LPM	260/484	288/534	343/637
Fan motor	Inlet/Outlet diameter(Water pipe)	mm	65A/65A	65A/65A	65A/65A
	Type	-	BLDC	BLDC	BLDC
	No. of Fan	EA	4	4	6
	No. of Vanes	EA	4	4	4
	Air Flow Rate	CMM	210 × 4 @1,000rpm	210 × 4 @1,000rpm	210 × 6 @1,000rpm
Motor power		W	900 × 4	900 × 4	900 × 6
Expansion unit		-	EEV	EEV	EEV
Weight		kg	970	970	1,430
Dimension	W	mm	1,528	1,528	2,291
	H	mm	2,293	2,293	2,293
	D	mm	2,154	2,154	2,154
Footprint		m ² /RT	0.089	0.078	0.101
Protection	High/Low Pressure	-	○	○	○
Devices	Anti Frost	-	○	○	○
Remote Control		-	Modbus	Modbus	Modbus
Power	Power Line	mm ² × C	50 × 5	50 × 5	95 × 5
Outlet	Cooling	°C	4~20	4~20	4~20
Temperature	Heating	°C	30~55	30~55	30~55
Ambient	Cooling	°C	-15~48	-15~48	-15~48
Temperature	Heating	°C	-30~35	-30~35	-30~35
Earth Leakage Breaker		A	125	125	200
Guaranteed Load Capacity Range		-	20% ~ 100%		

Notes:

1. Due to our policy of innovation some specifications may be changed without prior notification.
2. Capacities and Inputs are based on the following conditions
Cooling : Outdoor air temp. 35°C, Water inlet temp. 12°C, Water Outlet temp. 7°C
Heating : Outdoor air temp. 7°C, Water inlet temp. 40°C, Water Outlet temp. 45°C

3. Sound pressure level is measured on the rated condition in the anechoic rooms by ISO 3745 standard.
Sound power level is measured ISO 9614:2009 by sound intensity method.
Therefore, these values can be increased owing to ambient conditions during operation.

Air-Cooled Scroll Chiller (R410A)

3. Specifications

Inverter Scroll Chiller		Model	ACHH060LBAB	ACHH067LBAB
Power		Phase,Lines,V	3,4,380~415	3,4,380~415
Capacity	Cooling	kW	195.0	222.0
		RT	55.4	63.1
	Heating	kW	210.9	246.0
		RT	60	70
Input Power	Cooling	kW	66.6	82.2
	Heating	kW	64.9	82.0
Max operating Current		A	117	144
Efficiency	Cooling	W/W	2.93	2.70
	Heating	W/W	3.25	3.00
SEER		W/W	4.40	4.20
SCOP		W/W	3.30	3.30
Sound Pressure		dB(A)	68	68
Sound Power	Cooling	dB(A)	91	92
	Heating	dB(A)	91	92
Compressor	Type	-	Scroll	Scroll
	No. of Compressor	EA	6	6
	Oil Type	-	PVE	PVE
	Oil charge	cc	1,400 × 6	1,400 × 6
Refrigerant	Type	-	R410A	R410A
	Amount of Charged	kg	7.0 X 6	7.0 X 6
	GWP	-	2087.5	2087.5
	t-CO ₂ eq	-	87.68	87.68
Evaporator	Type	-	plate	plate
	Pressure drop	kPa	21.5	28.7
	Operating Maximum pressure (Refrigerant / Water)	kg/cm ²	42 / 10	42 / 10
	Water Flow Rate_ Standard(Cooling/Heating)	LPM	558/600	633/705
	Cold Water Flow Rate (Min. / Max.)	LPM	391/725	443/823
Fan motor	Inlet/Outlet diameter(Water pipe)	mm	65A/65A	65A/65A
	Type	-	BLDC	BLDC
	No. of Fan	EA	6	6
	No. of Vanes	EA	4	4
	Air Flow Rate	CMM	210 × 6 @ 1,000rpm	210 × 6 @ 1,000rpm
Motor power		W	900 × 6	900 × 6
Expansion unit		-	EEV	EEV
Weight		kg	1,430	1,430
Dimension	W	mm	2,291	2,291
	H	mm	2,293	2,293
	D	mm	2,154	2,154
Footprint		m ² /RT	0.089	0.078
Protection	High/Low Pressure	-	○	○
Devices	Anti Frost	-	○	○
Remote Control		-	Modbus	Modbus
Power	Power Line	mm ² × C	95 × 5	95 × 5
Outlet	Cooling	°C	4~20	4~20
Temperature	Heating	°C	30~55	30~55
Ambient	Cooling	°C	-15~48	-15~48
Temperature	Heating	°C	-30~35	-30~35
Earth Leakage Breaker		A	200	200
Guaranteed Load Capacity Range		-	20% ~ 100%	

Notes:

- Due to our policy of innovation some specifications may be changed without prior notification.
- Capacities and Inputs are based on the following conditions
Cooling : Outdoor air temp. 35°C, Water inlet temp. 12°C, Water Outlet temp. 7°C
Heating : Outdoor air temp. 7°C, Water inlet temp. 40°C, Water Outlet temp. 45°C
- Sound pressure level is measured on the rated condition in the anechoic rooms by ISO 3745 standard.
Sound power level is measured ISO 9614:2009 by sound intensity method.
Therefore, these values can be increased owing to ambient conditions during operation.

Air-Cooled Scroll Chiller (R410A)

4. Performance Data of Cooling

■ ACHH020LBAB

Capacity		Outdoor Temperature(°C)													
20% (13000 W)		-15	-10	-5	0	5	10	15	20	25	30	35	40	45	48
		Power Input(W)													
Outlet Water Temp. (°C)	5	1,504	1,412	1,494	1,581	1,668	1,668	1,862	1,968	2,511	3,055	3,736	4,876	5,782	6,323
	7	1,440	1,395	1,480	1,567	1,654	1,681	1,858	1,949	2,438	2,927	3,577	4,692	5,590	6,129
	9	-	-	-	-	-	1,567	1,602	1,698	2,201	2,705	3,370	4,456	5,326	5,846
	11	-	-	-	-	-	-	1,567	1,515	1,987	2,534	3,230	4,275	5,104	5,603
	13	-	-	-	-	-	-	-	-	1,867	2,388	3,042	4,068	4,827	5,283
	15	-	-	-	-	-	-	-	-	1,794	2,299	2,884	3,950	4,693	5,137
	20	-	-	-	-	-	-	-	-	1,723	2,213	2,734	3,835	4,563	4,995

Capacity		Outdoor Temperature(°C)													
40% (26000 W)		-15	-10	-5	0	5	10	15	20	25	30	35	40	45	48
		Power Input(W)													
Outlet Water Temp. (°C)	5	3,242	3,570	3,742	3,924	4,286	4,468	4,651	5,013	5,377	6,282	7,549	9,165	10,629	11,507
	7	3,104	3,278	3,451	3,628	4,075	4,252	4,430	4,786	5,141	6,027	7,258	8,858	10,217	11,029
	9	2,889	2,950	3,115	3,283	3,631	3,979	4,148	4,496	4,832	5,664	6,858	8,381	9,738	10,553
	11	-	-	-	-	3,282	3,540	3,709	4,237	4,575	5,409	6,584	8,050	9,348	10,126
	13	-	-	-	-	-	-	-	3,770	4,279	5,104	6,244	7,695	8,971	9,736
	15	-	-	-	-	-	-	-	-	3,867	4,815	5,914	7,320	8,528	9,250
	20	-	-	-	-	-	-	-	-	3,494	4,542	5,602	6,963	8,106	8,789

Capacity		Outdoor Temperature(°C)													
60% (39000 W)		-15	-10	-5	0	5	10	15	20	25	30	35	40	45	48
		Power Input(W)													
Outlet Water Temp. (°C)	5	5,536	6,183	6,185	6,185	6,598	7,011	7,011	7,244	8,151	9,350	10,984	13,086	15,045	-
	7	5,300	5,882	5,882	5,882	6,287	6,693	6,693	6,919	7,809	8,977	10,558	12,460	14,408	-
	9	4,933	5,496	5,497	5,497	5,808	6,208	6,208	6,429	7,300	8,440	9,965	11,792	13,577	-
	11	4,646	5,273	5,273	5,273	5,492	5,711	5,891	6,110	6,965	8,085	9,572	11,318	13,020	-
	13	-	-	-	-	5,144	5,169	5,348	5,912	6,561	7,630	9,073	10,749	12,406	13,404
	15	-	-	-	-	-	-	-	5,709	6,603	7,181	8,578	10,216	11,778	12,712
	20	-	-	-	-	-	-	-	5,513	6,646	6,759	8,109	9,709	11,181	12,057

Notes:

1) Water flow rate of test condition : 186 LPM

Air-Cooled Scroll Chiller (R410A)

4. Performance Data of Cooling

Capacity		Outdoor Temperature(°C)													
80% (52000 W)		-15	-10	-5	0	5	10	15	20	25	30	35	40	45	48
		Power Input(W)													
Outlet Water Temp. (°C)	5	8,881	9,191	9,474	9,784	10,273	10,763	11,073	11,562	11,956	12,566	14,778	17,408	-	-
	7	8,503	8,804	9,104	9,404	9,883	10,363	10,663	11,142	11,526	12,115	14,217	16,810	-	-
	9	7,915	8,317	8,599	8,884	9,349	9,814	10,099	10,564	10,935	11,496	13,498	15,907	-	-
	11	7,454	7,966	8,244	8,519	8,974	9,428	9,704	10,158	10,519	11,060	12,992	15,311	17,575	-
	13	7,074	7,735	7,995	8,257	8,521	8,963	9,226	9,669	10,018	10,535	12,384	14,597	16,742	-
	15	6,649	7,666	7,909	8,158	8,409	8,839	8,910	9,160	9,496	9,989	11,749	13,846	15,868	-
	20	6,250	7,598	7,823	8,061	8,300	8,715	8,605	8,677	9,001	9,470	11,146	13,135	15,039	-

Capacity		Outdoor Temperature(°C)													
100% (65000 W)		-15	-10	-5	0	5	10	15	20	25	30	35	40	45	48
		Power Input(W)													
Outlet Water Temp. (°C)	5	15,347	15,882	16,417	16,998	17,580	18,270	19,056	19,842	20,585	21,328	23,184	27,260	-	-
	7	14,694	15,223	15,772	16,327	16,886	17,563	18,249	18,941	19,675	20,530	22,184	26,018	-	-
	9	13,677	14,182	14,705	15,230	15,760	16,407	17,196	17,853	18,550	19,255	20,886	23,976	-	-
	11	12,880	13,392	13,924	14,459	15,021	15,665	16,350	17,016	17,710	18,431	19,951	22,931	-	-
	13	12,223	12,696	13,187	13,681	14,181	14,797	15,419	16,048	16,711	17,384	18,954	21,648	-	-
	15	11,489	11,944	12,417	12,893	13,374	13,970	14,573	15,180	15,821	16,471	17,814	20,425	-	-
	20	10,800	11,237	11,692	12,151	12,613	13,189	13,773	14,358	14,979	15,605	16,743	19,271	-	-

Notes:

1) Water flow rate of test condition : 186 LPM

Air-Cooled Scroll Chiller (R410A)

4. Performance Data of Cooling

■ ACHH023LBAB

Capacity		Outdoor Temperature(°C)													
20% (14800 W)		-15	-10	-5	0	5	10	15	20	25	30	35	40	45	48
		Power Input(W)													
Outlet Water Temp. (°C)	5	1,858	1,745	1,846	1,954	2,061	2,061	2,300	2,431	3,102	3,774	4,615	6,024	7,143	7,812
	7	1,779	1,723	1,829	1,936	2,044	2,076	2,296	2,408	3,012	3,617	4,419	5,796	6,906	7,572
	9	-	-	-	-	-	1,936	1,979	2,098	2,720	3,341	4,163	5,506	6,579	7,222
	11	-	-	-	-	-	-	1,936	1,872	2,455	3,130	3,991	5,282	6,306	6,923
	13	-	-	-	-	-	-	-	-	2,306	2,950	3,759	5,026	5,964	6,526
	15	-	-	-	-	-	-	-	-	2,216	2,840	3,563	4,880	5,798	6,346
	20	-	-	-	-	-	-	-	-	2,129	2,734	3,377	4,738	5,637	6,171

Capacity		Outdoor Temperature(°C)													
40% (29600 W)		-15	-10	-5	0	5	10	15	20	25	30	35	40	45	48
		Power Input(W)													
Outlet Water Temp. (°C)	5	4,005	4,411	4,622	4,848	5,295	5,520	5,746	6,193	6,644	7,761	9,327	11,323	13,131	14,217
	7	3,834	4,050	4,263	4,482	5,034	5,253	5,472	5,913	6,352	7,446	8,967	10,944	12,623	13,626
	9	3,569	3,644	3,848	4,056	4,486	4,916	5,124	5,554	5,970	6,998	8,472	10,354	12,031	13,038
	11	-	-	-	-	4,055	4,374	4,583	5,235	5,652	6,683	8,134	9,946	11,549	12,511
	13	-	-	-	-	-	-	-	4,658	5,287	6,306	7,714	9,507	11,084	12,028
	15	-	-	-	-	-	-	-	-	4,777	5,949	7,306	9,043	10,536	11,428
	20	-	-	-	-	-	-	-	-	4,317	5,612	6,920	8,602	10,015	10,859

Capacity		Outdoor Temperature(°C)													
60% (44400 W)		-15	-10	-5	0	5	10	15	20	25	30	35	40	45	48
		Power Input(W)													
Outlet Water Temp. (°C)	5	6,839	7,639	7,641	7,641	8,151	8,662	8,662	8,950	10,070	11,552	13,570	16,167	18,587	-
	7	6,548	7,266	7,266	7,266	7,768	8,269	8,269	8,548	9,647	11,090	13,044	15,393	17,800	-
	9	6,095	6,791	6,792	6,792	7,175	7,670	7,670	7,943	9,019	10,427	12,312	14,568	16,773	-
	11	5,740	6,514	6,514	6,514	6,785	7,056	7,277	7,548	8,604	9,988	11,825	13,983	16,085	-
	13	-	-	-	-	6,355	6,386	6,608	7,304	8,105	9,427	11,209	13,280	15,327	-
	15	-	-	-	-	-	-	-	7,053	8,158	8,872	10,597	12,621	14,550	-
	20	-	-	-	-	-	-	-	6,811	8,211	8,350	10,018	11,995	13,813	14,895

Notes:

1) Water flow rate of test condition : 211LPM

Air-Cooled Scroll Chiller (R410A)

4. Performance Data of Cooling

Capacity		Outdoor Temperature(°C)													
80% (59200 W)		-15	-10	-5	0	5	10	15	20	25	30	35	40	45	48
		Power Input(W)													
Outlet Water Temp. (°C)	5	10,972	11,355	11,705	12,088	12,692	13,297	13,680	14,284	14,772	15,524	18,258	21,506	-	-
	7	10,505	10,877	11,248	11,618	12,210	12,803	13,173	13,765	14,240	14,967	17,564	20,768	-	-
	9	9,779	10,275	10,623	10,976	11,550	12,125	12,477	13,052	13,509	14,203	16,676	19,652	-	-
	11	9,209	9,841	10,185	10,525	11,086	11,648	11,988	12,550	12,995	13,664	16,051	18,916	-	-
	13	8,739	9,556	9,877	10,201	10,527	11,074	11,399	11,946	12,376	13,016	15,300	18,033	-	-
	15	8,214	9,471	9,771	10,079	10,389	10,920	11,008	11,316	11,732	12,340	14,515	17,106	-	-
	20	7,721	9,386	9,665	9,958	10,254	10,767	10,631	10,721	11,121	11,700	13,770	16,227	-	-

Capacity		Outdoor Temperature(°C)													
100% (74000 W)		-15	-10	-5	0	5	10	15	20	25	30	35	40	45	48
		Power Input(W)													
Outlet Water Temp. (°C)	5	18,960	19,621	20,282	21,000	21,719	22,572	23,543	24,514	25,431	26,284	28,643	-	-	-
	7	18,153	18,807	19,486	20,171	20,862	21,698	22,545	23,400	24,307	25,264	27,407	-	-	-
	9	16,897	17,521	18,168	18,815	19,471	20,269	21,245	22,057	22,917	23,927	25,804	-	-	-
	11	15,913	16,545	17,203	17,864	18,557	19,353	20,200	21,022	21,880	22,500	24,648	-	-	-
	13	15,101	15,685	16,292	16,902	17,520	18,280	19,049	19,826	20,646	21,411	23,417	-	-	-
	15	14,194	14,756	15,340	15,929	16,523	17,259	18,004	18,753	19,546	20,384	22,009	25,234	-	-
	20	13,342	13,882	14,445	15,012	15,582	16,295	17,015	17,739	18,506	19,406	20,685	23,809	-	-

Notes:

1) Water flow rate of test condition : 211LPM

Air-Cooled Scroll Chiller (R410A)

4. Performance Data of Cooling

■ ACHH033LBAB

Capacity		Outdoor Temperature(°C)														
20% (22800 W)		-15	-10	-5	0	5	10	15	20	25	30	35	40	45	48	
		Power Input(W)														
Outlet Water Temp. (°C)	5	2,493	3,138	3,321	3,514	3,708	3,708	4,137	4,374	5,581	6,789	8,302	10,837	12,850	14,053	
	7	2,387	3,099	3,290	3,483	3,677	3,735	4,130	4,331	5,419	6,506	7,950	10,427	12,424	13,620	
	9	-	-	-	-	-	3,483	3,561	3,774	4,892	6,011	7,489	9,904	11,836	12,992	
	11	-	-	-	-	-	-	3,483	3,367	4,416	5,631	7,180	9,502	11,344	12,453	
	13	-	-	-	-	-	-	-	-	4,149	5,306	6,762	9,041	10,729	11,740	
	15	-	-	-	-	-	-	-	-	-	3,986	5,109	6,409	8,778	10,431	11,416
	20	-	-	-	-	-	-	-	-	-	2,167	2,229	2,384	2,771	3,065	3,408

Capacity		Outdoor Temperature(°C)														
40% (45600 W)		-15	-10	-5	0	5	10	15	20	25	30	35	40	45	48	
		Power Input(W)														
Outlet Water Temp. (°C)	5	5,373	7,934	8,315	8,721	9,525	9,930	10,336	11,140	11,951	13,961	16,778	20,369	23,621	25,575	
	7	5,145	7,286	7,669	8,063	9,056	9,450	9,844	10,638	11,426	13,395	16,131	19,687	22,708	24,511	
	9	4,789	6,555	6,923	7,297	8,070	8,844	9,218	9,991	10,740	12,589	15,241	18,626	21,642	23,454	
	11	-	-	-	-	7,294	7,868	8,243	9,417	10,167	12,022	14,632	17,891	20,776	22,506	
	13	-	-	-	-	-	-	-	-	8,379	9,511	11,344	13,876	17,101	19,938	21,637
	15	-	-	-	-	-	-	-	-	-	8,594	10,701	13,143	16,268	18,953	20,558
	20	-	-	-	-	-	-	-	-	-	4,671	4,805	5,139	5,973	6,607	7,348

Capacity		Outdoor Temperature(°C)														
60% (68400 W)		-15	-10	-5	0	5	10	15	20	25	30	35	40	45	48	
		Power Input(W)														
Outlet Water Temp. (°C)	5	9,176	13,741	13,746	13,746	14,664	15,581	15,581	16,100	18,115	20,780	24,411	29,084	33,437	-	
	7	8,786	13,071	13,071	13,071	13,973	14,875	14,875	15,378	17,354	19,950	23,464	27,691	32,020	34,635	
	9	8,178	12,216	12,218	12,218	12,908	13,798	13,798	14,288	16,224	18,757	22,148	26,207	30,173	32,558	
	11	7,702	11,719	11,719	11,719	12,206	12,692	13,091	13,578	15,478	17,967	21,272	25,153	28,936	31,213	
	13	-	-	-	-	11,432	11,487	11,886	13,139	14,581	16,958	20,165	23,889	27,571	29,789	
	15	-	-	-	-	-	-	-	-	12,688	14,675	15,960	19,063	22,704	26,175	28,252
	20	-	-	-	-	-	-	-	-	7,635	7,977	8,205	8,775	10,200	11,282	12,547

Notes:

1) Water flow rate of test condition : 327 LPM

Air-Cooled Scroll Chiller (R410A)

4. Performance Data of Cooling

Capacity		Outdoor Temperature(°C)													
80% (91200 W)		-15	-10	-5	0	5	10	15	20	25	30	35	40	45	48
		Power Input(W)													
Outlet Water Temp. (°C)	5	14,722	20,426	21,056	21,744	22,832	23,920	24,608	25,696	26,573	27,927	32,844	38,688	44,473	-
	7	14,096	19,566	20,234	20,900	21,965	23,031	23,697	24,762	25,616	26,925	31,596	37,359	42,957	-
	9	13,120	18,483	19,110	19,745	20,778	21,811	22,445	23,479	24,302	25,549	29,999	35,352	43,033	-
	11	12,356	17,703	18,321	18,933	19,943	20,954	21,566	22,576	23,377	24,581	28,875	34,029	39,058	-
	13	11,726	17,191	17,768	18,350	18,937	19,921	20,505	21,489	22,264	23,414	27,523	32,440	37,209	-
	15	11,022	17,037	17,576	18,131	18,690	19,643	19,803	20,357	21,104	22,199	26,111	30,773	35,265	-
	20	9,155	9,508	9,873	10,239	10,696	11,245	11,702	12,250	12,799	13,164	14,079	16,364	18,101	-

Capacity		Outdoor Temperature(°C)													
100% (114000 W)		-15	-10	-5	0	5	10	15	20	25	30	35	40	45	48
		Power Input(W)													
Outlet Water Temp. (°C)	5	25,439	26,327	27,214	28,177	29,141	30,286	31,589	32,891	34,123	35,641	38,432	45,188	-	-
	7	24,357	25,235	26,145	27,065	27,992	29,114	30,250	31,398	32,614	34,137	36,774	43,129	-	-
	9	22,672	23,509	24,376	25,246	26,126	27,197	28,506	29,595	30,749	32,205	34,623	39,744	-	-
	11	21,351	22,200	23,082	23,969	24,899	25,967	27,103	28,207	29,357	30,839	33,072	38,013	-	-
	13	20,261	21,045	21,860	22,678	23,507	24,528	25,559	26,602	27,702	29,104	31,420	35,885	-	-
	15	19,045	19,799	20,583	21,372	22,169	23,157	24,156	25,163	26,227	27,589	29,530	33,858	-	-
	20	15,820	16,429	17,061	17,693	18,482	19,430	20,220	21,168	22,116	22,748	24,327	28,277	31,278	-

Notes:

1) Water flow rate of test condition : 327 LPM

Air-Cooled Scroll Chiller (R410A)

4. Performance Data of Cooling

■ ACHH040LBAB

Capacity		Outdoor Temperature(°C)													
20% (26000 W)		-15	-10	-5	0	5	10	15	20	25	30	35	40	45	48
		Power Input(W)													
Outlet Water Temp. (°C)	5	3,007	2,824	2,988	3,163	3,337	3,337	3,723	3,936	5,022	6,109	7,471	9,752	11,564	12,646
	7	2,879	2,789	2,961	3,135	3,309	3,361	3,716	3,897	4,876	5,855	7,154	9,383	11,180	12,257
	9	-	-	-	-	-	3,135	3,204	3,396	4,403	5,409	6,740	8,913	10,651	11,691
	11	-	-	-	-	-	-	3,135	3,030	3,974	5,068	6,461	8,551	10,209	11,207
	13	-	-	-	-	-	-	-	-	3,734	4,775	6,085	8,136	9,655	10,565
	15	-	-	-	-	-	-	-	-	3,587	4,598	5,768	7,899	9,387	10,273
	20	-	-	-	-	-	-	-	-	3,447	4,427	5,467	7,669	9,126	9,990

Capacity		Outdoor Temperature(°C)													
40% (52000 W)		-15	-10	-5	0	5	10	15	20	25	30	35	40	45	48
		Power Input(W)													
Outlet Water Temp. (°C)	5	6,483	7,140	7,483	7,848	8,572	8,937	9,301	10,025	10,755	12,564	15,099	18,331	21,257	23,015
	7	6,207	6,557	6,901	7,256	8,149	8,504	8,859	9,573	10,282	12,054	14,516	17,717	20,435	22,058
	9	5,778	5,899	6,230	6,567	7,263	7,958	8,295	8,991	9,665	11,329	13,715	16,761	19,476	21,107
	11	-	-	-	-	6,564	7,081	7,418	8,474	9,149	10,819	13,167	16,101	18,697	20,253
	13	-	-	-	-	-	-	-	7,541	8,559	10,208	12,487	15,390	17,943	19,471
	15	-	-	-	-	-	-	-	-	7,734	9,630	11,828	14,639	17,056	18,501
	20	-	-	-	-	-	-	-	-	6,988	9,085	11,203	13,925	16,213	17,578

Capacity		Outdoor Temperature(°C)													
60% (78000 W)		-15	-10	-5	0	5	10	15	20	25	30	35	40	45	48
		Power Input(W)													
Outlet Water Temp. (°C)	5	11,071	12,366	12,370	12,370	13,196	14,022	14,022	14,489	16,302	18,700	21,968	26,173	30,090	-
	7	10,600	11,763	11,763	11,763	12,575	13,386	13,386	13,839	15,617	17,954	21,116	24,920	28,816	-
	9	9,867	10,993	10,995	10,995	11,616	12,417	12,417	12,858	14,601	16,880	19,931	23,584	27,153	-
	11	9,292	10,546	10,546	10,546	10,984	11,422	11,781	12,219	13,929	16,169	19,143	22,636	26,040	-
	13	-	-	-	-	10,287	10,338	10,697	11,824	13,121	15,261	18,146	21,498	24,812	26,808
	15	-	-	-	-	-	-	-	11,418	13,207	14,363	17,155	20,431	23,555	25,425
	20	-	-	-	-	-	-	-	11,027	13,293	13,518	16,218	19,418	22,362	24,113

Notes:

1) Water flow rate of test condition : 372 LPM

Air-Cooled Scroll Chiller (R410A)

4. Performance Data of Cooling

Capacity		Outdoor Temperature(°C)													
80% (104000 W)		-15	-10	-5	0	5	10	15	20	25	30	35	40	45	48
		Power Input(W)													
Outlet Water Temp. (°C)	5	17,763	18,382	18,948	19,568	20,547	21,526	22,145	23,124	23,913	25,131	29,556	34,816	-	-
	7	17,007	17,608	18,209	18,808	19,767	20,726	21,325	22,284	23,052	24,230	28,434	33,620	-	-
	9	15,830	16,633	17,198	17,768	18,698	19,628	20,199	21,129	21,870	22,992	26,997	31,814	-	-
	11	14,908	15,931	16,487	17,038	17,947	18,857	19,407	20,317	21,038	22,121	25,985	30,623	35,149	-
	13	14,147	15,470	15,989	16,514	17,042	17,927	18,453	19,338	20,035	21,071	24,768	29,193	33,485	-
	15	13,298	15,332	15,817	16,316	16,819	17,677	17,821	18,320	18,992	19,977	23,498	27,693	31,736	-
	20	12,500	15,195	15,647	16,121	16,599	17,431	17,210	17,355	18,003	18,940	22,292	26,269	30,078	-

Capacity		Outdoor Temperature(°C)													
100% (130000 W)		-15	-10	-5	0	5	10	15	20	25	30	35	40	45	48
		Power Input(W)													
Outlet Water Temp. (°C)	5	30,693	31,763	32,834	33,997	35,160	36,540	38,112	39,684	41,169	42,656	46,369	54,520	-	-
	7	29,387	30,447	31,544	32,654	33,772	35,126	36,497	37,882	39,350	41,060	44,369	52,035	-	-
	9	27,354	28,364	29,411	30,459	31,521	32,813	34,393	35,707	37,099	38,511	41,773	47,952	-	-
	11	25,761	26,784	27,848	28,919	30,042	31,330	32,700	34,032	35,420	36,862	39,902	45,863	-	-
	13	24,446	25,392	26,374	27,361	28,362	29,593	30,838	32,095	33,423	34,769	37,909	43,296	-	-
	15	22,978	23,888	24,834	25,786	26,748	27,940	29,145	30,359	31,643	32,941	35,629	40,850	-	-
	20	21,599	22,474	23,384	24,301	25,225	26,379	27,545	28,717	29,958	31,210	33,486	38,543	-	-

Notes:

1) Water flow rate of test condition : 372 LPM

Air-Cooled Scroll Chiller (R410A)

4. Performance Data of Cooling

■ ACHH045LBAB

Capacity		Outdoor Temperature(°C)													
20% (29600 W)		-15	-10	-5	0	5	10	15	20	25	30	35	40	45	48
		Power Input(W)													
Outlet Water Temp. (°C)	5	3,715	3,489	3,692	3,907	4,122	4,122	4,600	4,862	6,205	7,548	9,230	12,049	14,286	15,624
	7	3,557	3,446	3,658	3,873	4,088	4,152	4,591	4,815	6,024	7,233	8,838	11,592	13,813	15,143
	9	-	-	-	-	-	3,873	3,959	4,195	5,439	6,683	8,326	11,011	13,159	14,444
	11	-	-	-	-	-	-	3,873	3,744	4,910	6,261	7,982	10,564	12,612	13,846
	13	-	-	-	-	-	-	-	-	4,613	5,899	7,517	10,052	11,928	13,053
	15	-	-	-	-	-	-	-	-	4,432	5,680	7,126	9,759	11,597	12,692
	20	-	-	-	-	-	-	-	-	4,258	5,469	6,755	9,475	11,275	12,342

Capacity		Outdoor Temperature(°C)													
40% (52000 W)		-15	-10	-5	0	5	10	15	20	25	30	35	40	45	48
		Power Input(W)													
Outlet Water Temp. (°C)	5	8,010	8,821	9,245	9,696	10,590	11,041	11,491	12,386	13,287	15,522	18,654	22,646	26,262	28,434
	7	7,669	8,100	8,526	8,965	10,068	10,507	10,945	11,827	12,703	14,892	17,934	21,888	25,246	27,251
	9	7,138	7,288	7,697	8,113	8,973	9,832	10,248	11,108	11,940	13,996	16,945	20,708	24,062	26,076
	11	-	-	-	-	8,109	8,748	9,165	10,469	11,303	13,366	16,267	19,892	23,099	25,021
	13	-	-	-	-	-	-	-	9,316	10,574	12,612	15,427	19,013	22,167	24,055
	15	-	-	-	-	-	-	-	-	9,555	11,898	14,613	18,086	21,072	22,856
	20	-	-	-	-	-	-	-	-	8,633	11,224	13,841	17,204	20,030	21,717

Capacity		Outdoor Temperature(°C)													
60% (88800 W)		-15	-10	-5	0	5	10	15	20	25	30	35	40	45	48
		Power Input(W)													
Outlet Water Temp. (°C)	5	13,678	15,278	15,282	15,282	16,303	17,323	17,323	17,900	20,140	23,103	27,140	32,335	37,175	-
	7	13,096	14,533	14,533	14,533	15,535	16,538	16,538	17,097	19,294	22,181	26,087	30,787	35,600	-
	9	12,190	13,581	13,583	13,583	14,351	15,340	15,340	15,886	18,038	20,854	24,623	29,136	33,546	-
	11	11,480	13,029	13,029	13,029	13,570	14,111	14,555	15,096	17,209	19,976	23,650	27,965	32,171	-
	13	-	-	-	-	12,709	12,772	13,215	14,608	16,210	18,854	22,419	26,559	30,654	-
	15	-	-	-	-	-	-	-	14,107	16,316	17,744	21,194	25,242	29,101	-
	20	-	-	-	-	-	-	-	13,623	16,422	16,701	20,037	23,989	27,627	29,790

Notes:

1) Water flow rate of test condition : 411LPM

Air-Cooled Scroll Chiller (R410A)

4. Performance Data of Cooling

Capacity		Outdoor Temperature(°C)													
80% (118400 W)		-15	-10	-5	0	5	10	15	20	25	30	35	40	45	48
		Power Input(W)													
Outlet Water Temp. (°C)	5	21,945	22,710	23,409	24,175	25,384	26,594	27,359	28,569	29,543	31,048	36,515	43,013	-	-
	7	21,011	21,753	22,496	23,236	24,421	25,605	26,346	27,531	28,480	29,935	35,128	41,535	-	-
	9	19,557	20,550	21,247	21,952	23,101	24,249	24,954	26,103	27,019	28,406	33,353	39,304	-	-
	11	18,418	19,682	20,369	21,049	22,173	23,296	23,976	25,100	25,991	27,329	32,103	37,833	-	-
	13	17,478	19,113	19,754	20,402	21,054	22,147	22,797	23,891	24,752	26,032	30,600	36,067	-	-
	15	16,429	18,942	19,541	20,158	20,779	21,839	22,016	22,633	23,463	24,680	29,030	34,213	-	-
	20	15,443	18,773	19,330	19,917	20,507	21,535	21,262	21,441	22,241	23,399	27,541	32,454	-	-

Capacity		Outdoor Temperature(°C)													
100% (148000 W)		-15	-10	-5	0	5	10	15	20	25	30	35	40	45	48
		Power Input(W)													
Outlet Water Temp. (°C)	5	37,920	39,242	40,564	42,001	43,438	45,143	47,085	49,027	50,862	52,567	57,286	-	-	-
	7	36,306	37,615	38,971	40,342	41,724	43,396	45,090	46,801	48,614	50,528	54,815	-	-	-
	9	33,794	35,041	36,335	37,631	38,942	40,539	42,490	44,114	45,834	47,853	51,608	-	-	-
	11	31,826	33,090	34,405	35,728	37,115	38,706	40,399	42,044	43,759	45,001	49,296	-	-	-
	13	30,201	31,370	32,584	33,803	35,039	36,561	38,098	39,652	41,292	42,823	46,834	-	-	-
	15	28,388	29,512	30,681	31,857	33,045	34,518	36,007	37,507	39,093	40,768	44,017	50,468	-	-
	20	26,684	27,765	28,889	30,023	31,164	32,589	34,031	35,478	37,011	38,813	41,370	47,617	-	-

Notes:

1) Water flow rate of test condition : 411LPM

Air-Cooled Scroll Chiller (R410A)

4. Performance Data of Cooling

■ ACHH050LBAB

Capacity		Outdoor Temperature(°C)														
20% (34200 W)		-15	-10	-5	0	5	10	15	20	25	30	35	40	45	48	
		Power Input(W)														
Outlet Water Temp. (°C)	5	3,739	4,707	4,981	5,271	5,562	5,562	6,206	6,560	8,372	10,183	12,453	16,256	19,274	21,079	
	7	3,580	4,649	4,935	5,225	5,515	5,602	6,195	6,496	8,128	9,759	11,925	15,640	18,636	20,431	
	9	-	-	-	-	-	5,225	5,341	5,660	7,338	9,016	11,234	14,856	17,753	19,487	
	11	-	-	-	-	-	-	5,225	5,051	6,624	8,447	10,769	14,253	17,016	18,680	
	13	-	-	-	-	-	-	-	-	6,224	7,959	10,142	13,562	16,093	17,610	
	15	-	-	-	-	-	-	-	-	-	5,980	7,663	9,614	13,167	15,646	17,124
	20	-	-	-	-	-	-	-	-	-	5,745	7,378	9,113	12,784	15,211	16,651

Capacity		Outdoor Temperature(°C)													
40% (68400 W)		-15	-10	-5	0	5	10	15	20	25	30	35	40	45	48
		Power Input(W)													
Outlet Water Temp. (°C)	5	8,060	11,901	12,473	13,081	14,288	14,896	15,504	16,710	17,927	20,942	25,167	30,554	35,432	38,362
	7	7,717	10,929	11,503	12,095	13,584	14,175	14,766	15,956	17,139	20,092	24,196	29,531	34,061	36,767
	9	7,183	9,833	10,384	10,946	12,105	13,265	13,827	14,987	16,110	18,883	22,861	27,939	32,463	35,181
	11	-	-	-	-	10,941	11,803	12,365	14,125	15,250	18,033	21,947	26,837	31,164	33,758
	13	-	-	-	-	-	-	-	12,569	14,266	17,016	20,814	25,652	29,908	32,455
	15	-	-	-	-	-	-	-	-	12,891	16,052	19,715	24,401	28,429	30,837
	20	-	-	-	-	-	-	-	-	-	11,648	15,143	18,674	23,211	27,024

Capacity		Outdoor Temperature(°C)														
60% (102600 W)		-15	-10	-5	0	5	10	15	20	25	30	35	40	45	48	
		Power Input(W)														
Outlet Water Temp. (°C)	5	13,764	20,612	20,619	20,619	21,995	23,372	23,372	24,150	27,172	31,170	36,617	43,625	50,155	-	
	7	13,179	19,607	19,607	19,607	20,960	22,312	22,312	23,067	26,032	29,926	35,196	41,537	48,031	51,952	
	9	12,267	18,323	18,326	18,326	19,362	20,697	20,697	21,433	24,337	28,136	33,221	39,310	45,259	48,837	
	11	11,552	17,578	17,578	17,578	18,308	19,039	19,637	20,367	23,217	26,951	31,909	37,730	43,404	46,820	
	13	-	-	-	-	17,147	17,231	17,830	19,709	21,871	25,437	30,247	35,833	41,357	44,684	
	15	-	-	-	-	-	-	-	-	19,033	22,013	23,940	28,595	34,055	39,262	42,379
	20	-	-	-	-	-	-	-	-	18,380	22,157	22,532	27,033	32,366	37,274	40,192

Notes:

1) Water flow rate of test condition : 491 LPM

Air-Cooled Scroll Chiller (R410A)

4. Performance Data of Cooling

Capacity		Outdoor Temperature(°C)													
80% (136800 W)		-15	-10	-5	0	5	10	15	20	25	30	35	40	45	48
		Power Input(W)													
Outlet Water Temp. (°C)	5	22,083	30,640	31,583	32,616	34,248	35,880	36,913	38,544	39,859	41,890	49,265	58,032	66,710	-
	7	21,144	29,349	30,351	31,350	32,948	34,546	35,546	37,144	38,424	40,388	47,394	56,039	64,436	-
	9	19,681	27,725	28,666	29,617	31,167	32,717	33,668	35,218	36,453	38,324	44,999	53,028	64,549	-
	11	18,534	26,555	27,482	28,399	29,915	31,431	32,348	33,864	35,066	36,871	43,312	51,043	58,588	-
	13	17,588	25,786	26,652	27,526	28,405	29,881	30,758	32,233	33,395	35,121	41,284	48,660	55,813	-
	15	16,533	25,556	26,364	27,196	28,034	29,465	29,704	30,536	31,656	33,298	39,166	46,159	52,898	-
	20	15,540	25,328	26,080	26,871	27,668	29,054	28,687	28,928	30,007	31,570	37,157	43,786	50,135	-

Capacity		Outdoor Temperature(°C)													
100% (171000 W)		-15	-10	-5	0	5	10	15	20	25	30	35	40	45	48
		Power Input(W)													
Outlet Water Temp. (°C)	5	38,159	39,490	40,820	42,266	43,712	45,428	47,383	49,337	51,184	53,462	57,648	67,782	-	-
	7	36,536	37,853	39,217	40,597	41,988	43,671	45,375	47,096	48,921	51,205	55,161	64,693	-	-
	9	34,008	35,263	36,565	37,868	39,188	40,795	42,759	44,393	46,124	48,308	51,934	59,616	-	-
	11	32,027	33,299	34,623	35,953	37,349	38,950	40,655	42,310	44,036	46,258	49,608	57,019	-	-
	13	30,392	31,568	32,790	34,017	35,261	36,792	38,339	39,903	41,553	43,656	47,130	53,827	-	-
	15	28,568	29,699	30,875	32,058	33,254	34,736	36,235	37,744	39,340	41,384	44,295	50,787	-	-
	20	26,853	27,940	29,072	30,213	31,361	32,795	34,246	35,702	37,245	39,230	41,631	47,918	54,434	-

Notes:

1) Water flow rate of test condition : 491 LPM

Air-Cooled Scroll Chiller (R410A)

4. Performance Data of Cooling

■ ACHH060LBAB

Capacity		Outdoor Temperature(°C)													
20% (39000 W)		-15	-10	-5	0	5	10	15	20	25	30	35	40	45	48
		Power Input(W)													
Outlet Water Temp. (°C)	5	4,511	4,236	4,483	4,744	5,005	5,005	5,585	5,904	7,534	9,164	11,207	14,629	17,345	18,969
	7	4,319	4,184	4,441	4,702	4,963	5,042	5,575	5,846	7,314	8,782	10,731	14,075	16,771	18,386
	9	-	-	-	-	-	4,702	4,807	5,094	6,604	8,114	10,109	13,369	15,977	17,537
	11	-	-	-	-	-	-	4,702	4,545	5,961	7,602	9,691	12,826	15,313	16,810
	13	-	-	-	-	-	-	-	-	5,601	7,163	9,127	12,204	14,482	15,848
	15	-	-	-	-	-	-	-	-	5,381	6,896	8,652	11,849	14,080	15,410
	20	-	-	-	-	-	-	-	-	5,170	6,640	8,201	11,504	13,689	14,984

Capacity		Outdoor Temperature(°C)													
40% (78000 W)		-15	-10	-5	0	5	10	15	20	25	30	35	40	45	48
		Power Input(W)													
Outlet Water Temp. (°C)	5	9,725	10,710	11,225	11,772	12,858	13,405	13,952	15,038	16,132	18,846	22,648	27,496	31,886	34,522
	7	9,311	9,835	10,352	10,884	12,224	12,756	13,289	14,359	15,424	18,081	21,774	26,575	30,652	33,087
	9	8,667	8,849	9,345	9,850	10,894	11,938	12,443	13,487	14,497	16,993	20,573	25,142	29,214	31,660
	11	-	-	-	-	9,846	10,621	11,128	12,711	13,724	16,228	19,751	24,151	28,045	30,379
	13	-	-	-	-	-	-	-	11,311	12,838	15,313	18,731	23,085	26,914	29,207
	15	-	-	-	-	-	-	-	-	11,601	14,445	17,742	21,959	25,584	27,751
	20	-	-	-	-	-	-	-	-	10,482	13,627	16,805	20,888	24,319	26,368

Capacity		Outdoor Temperature(°C)													
60% (117000 W)		-15	-10	-5	0	5	10	15	20	25	30	35	40	45	48
		Power Input(W)													
Outlet Water Temp. (°C)	5	16,607	18,549	18,555	18,555	19,794	21,033	21,033	21,733	24,453	28,051	32,952	39,259	45,135	-
	7	15,900	17,645	17,645	17,645	18,862	20,079	20,079	20,758	23,426	26,930	31,674	37,379	43,223	-
	9	14,800	16,489	16,492	16,492	17,424	18,625	18,625	19,288	21,901	25,320	29,896	35,376	40,730	-
	11	13,938	15,818	15,819	15,819	16,476	17,133	17,672	18,329	20,894	24,254	28,715	33,954	39,060	-
	13	-	-	-	-	15,431	15,507	16,045	17,736	19,682	22,891	27,219	32,246	37,218	40,211
	15	-	-	-	-	-	-	-	17,128	19,810	21,544	25,733	30,647	35,333	38,137
	20	-	-	-	-	-	-	-	16,540	19,939	20,277	24,328	29,126	33,543	36,170

Notes:

1) Water flow rate of test condition : 558LPM

Air-Cooled Scroll Chiller (R410A)

4. Performance Data of Cooling

Capacity		Outdoor Temperature(°C)													
80% (156000 W)		-15	-10	-5	0	5	10	15	20	25	30	35	40	45	48
		Power Input(W)													
Outlet Water Temp. (°C)	5	26,644	27,573	28,422	29,352	30,820	32,288	33,218	34,686	35,869	37,697	44,335	52,223	-	-
	7	25,510	26,412	27,313	28,212	29,650	31,088	31,988	33,426	34,579	36,345	42,651	50,430	-	-
	9	23,745	24,950	25,796	26,653	28,047	29,442	30,298	31,693	32,804	34,488	40,495	47,721	-	-
	11	22,362	23,897	24,731	25,557	26,921	28,285	29,111	30,475	31,556	33,181	38,977	45,934	52,724	-
	13	21,221	23,205	23,984	24,771	25,562	26,890	27,679	29,007	30,053	31,606	37,152	43,790	50,227	-
	15	19,947	22,998	23,726	24,474	25,228	26,516	26,731	27,480	28,488	29,966	35,246	41,539	47,604	-
	20	18,750	22,793	23,470	24,182	24,899	26,146	25,815	26,032	27,004	28,410	33,438	39,404	45,117	-

Capacity		Outdoor Temperature(°C)													
100% (195000 W)		-15	-10	-5	0	5	10	15	20	25	30	35	40	45	48
		Power Input(W)													
Outlet Water Temp. (°C)	5	46,040	47,645	49,250	50,995	52,739	54,810	57,168	59,526	61,754	63,985	69,553	81,779	-	-
	7	44,081	45,670	47,316	48,981	50,659	52,689	54,746	56,823	59,024	61,590	66,553	78,053	-	-
	9	41,031	42,545	44,116	45,689	47,281	49,220	51,589	53,560	55,649	57,766	62,659	71,927	-	-
	11	38,641	40,176	41,773	43,378	45,062	46,994	49,050	51,048	53,130	55,293	59,852	68,794	-	-
	13	36,668	38,087	39,561	41,042	42,543	44,390	46,257	48,143	50,134	52,153	56,863	64,943	-	-
	15	34,467	35,832	37,251	38,679	40,121	41,910	43,718	45,539	47,464	49,412	53,443	61,275	-	-
	20	32,399	33,711	35,076	36,452	37,838	39,568	41,318	43,075	44,937	46,815	50,229	57,814	-	-

Notes:

1) Water flow rate of test condition : 558LPM

Air-Cooled Scroll Chiller (R410A)

4. Performance Data of Cooling

■ ACHH067LBAB

Capacity		Outdoor Temperature(°C)													
20% (44400 W)		-15	-10	-5	0	5	10	15	20	25	30	35	40	45	48
		Power Input(W)													
Outlet Water Temp. (°C)	5	5,573	5,234	5,538	5,861	6,183	6,183	6,900	7,294	9,307	11,321	13,845	18,073	21,429	23,435
	7	5,336	5,169	5,486	5,809	6,132	6,229	6,887	7,223	9,036	10,850	13,258	17,389	20,719	22,715
	9	-	-	-	-	-	5,809	5,938	6,293	8,159	10,024	12,490	16,517	19,738	21,666
	11	-	-	-	-	-	-	5,809	5,615	7,365	9,391	11,973	15,846	18,918	20,768
	13	-	-	-	-	-	-	-	-	6,919	8,849	11,276	15,078	17,892	19,579
	15	-	-	-	-	-	-	-	-	6,648	8,520	10,689	14,639	17,395	19,038
	20	-	-	-	-	-	-	-	-	6,388	8,203	10,132	14,213	16,912	18,512

Capacity		Outdoor Temperature(°C)													
40% (88800 W)		-15	-10	-5	0	5	10	15	20	25	30	35	40	45	48
		Power Input(W)													
Outlet Water Temp. (°C)	5	12,014	13,232	13,867	14,543	15,885	16,561	17,237	18,578	19,931	23,283	27,981	33,970	39,393	42,650
	7	11,503	12,150	12,789	13,447	15,102	15,760	16,417	17,740	19,055	22,338	26,901	32,832	37,869	40,877
	9	10,707	10,932	11,545	12,169	13,459	14,748	15,372	16,662	17,910	20,994	25,417	31,062	36,092	39,114
	11	-	-	-	-	12,164	13,122	13,748	15,704	16,955	20,049	24,401	29,837	34,648	37,532
	13	-	-	-	-	-	-	-	13,974	15,861	18,918	23,141	28,520	33,251	36,083
	15	-	-	-	-	-	-	-	-	14,332	17,847	21,919	27,129	31,607	34,285
	20	-	-	-	-	-	-	-	-	12,950	16,836	20,761	25,806	30,045	32,576

Capacity		Outdoor Temperature(°C)													
60% (133200 W)		-15	-10	-5	0	5	10	15	20	25	30	35	40	45	48
		Power Input(W)													
Outlet Water Temp. (°C)	5	20,517	22,916	22,924	22,924	24,454	25,985	25,985	26,850	30,210	34,655	40,710	48,502	55,762	-
	7	19,644	21,799	21,799	21,799	23,303	24,807	24,807	25,645	28,942	33,271	39,131	46,180	53,400	-
	9	18,285	20,372	20,375	20,375	21,526	23,010	23,010	23,829	27,057	31,281	36,935	43,705	50,319	-
	11	17,220	19,543	19,543	19,543	20,355	21,167	21,832	22,644	25,813	29,964	35,476	41,948	48,256	-
	13	-	-	-	-	19,064	19,157	19,823	21,912	24,316	28,280	33,628	39,839	45,980	-
	15	-	-	-	-	-	-	-	21,160	24,474	26,617	31,791	37,862	43,651	-
	20	-	-	-	-	-	-	-	20,434	24,633	25,051	30,055	35,984	41,440	44,686

Notes:

1) Water flow rate of test condition : 617LPM

Air-Cooled Scroll Chiller (R410A)

4. Performance Data of Cooling

Capacity		Outdoor Temperature(°C)													
80% (177600 W)		-15	-10	-5	0	5	10	15	20	25	30	35	40	45	48
		Power Input(W)													
Outlet Water Temp. (°C)	5	32,917	34,065	35,114	36,263	38,077	39,890	41,039	42,853	44,315	46,573	54,773	64,519	-	-
	7	31,516	32,630	33,743	34,855	36,631	38,408	39,519	41,296	42,720	44,902	52,692	62,303	-	-
	9	29,336	30,824	31,870	32,928	34,651	36,374	37,432	39,155	40,528	42,608	50,029	58,956	-	-
	11	27,627	29,523	30,554	31,574	33,259	34,945	35,965	37,650	38,986	40,993	48,154	56,749	-	-
	13	26,217	28,669	29,631	30,603	31,581	33,221	34,196	35,837	37,129	39,047	45,899	54,100	-	-
	15	24,643	28,413	29,312	30,237	31,168	32,759	33,025	33,949	35,195	37,021	43,545	51,319	-	-
	20	23,164	28,159	28,996	29,875	30,761	32,302	31,893	32,162	33,362	35,099	41,311	48,681	-	-

Capacity		Outdoor Temperature(°C)													
100% (222000 W)		-15	-10	-5	0	5	10	15	20	25	30	35	40	45	48
		Power Input(W)													
Outlet Water Temp. (°C)	5	56,879	58,863	60,846	63,001	65,156	67,715	70,628	73,541	76,293	78,851	85,929	-	-	-
	7	54,459	56,422	58,457	60,513	62,586	65,094	67,635	70,201	72,921	75,793	82,222	-	-	-
	9	50,691	52,562	54,503	56,446	58,413	60,808	63,736	66,171	68,751	71,780	77,412	-	-	-
	11	47,739	49,635	51,608	53,591	55,672	58,059	60,599	63,066	65,639	67,501	73,944	-	-	-
	13	45,302	47,055	48,876	50,705	52,559	54,841	57,147	59,478	61,937	64,234	70,251	-	-	-
	15	42,583	44,269	46,021	47,786	49,568	51,777	54,011	56,260	58,639	61,153	66,026	75,702	-	-
	20	40,027	41,647	43,334	45,035	46,746	48,884	51,046	53,217	55,517	58,219	62,054	71,426	-	-

Notes:

1) Water flow rate of test condition : 617LPM

Air-Cooled Scroll Chiller (R410A)

5. Performance Data of Heating

■ ACHH020LBAB

Capacity		Outlet Water Temp(°C)					
20% (14000W)		30	35	40	45	50	55
		Power Input(W)					
Outdoor Temp. (°C)	-30	10,134	-	-	-	-	-
	-25	9,472	10,001	-	-	-	-
	-20	8,709	9,144	9,822	-	-	-
	-15	6,991	7,381	7,928	8,391	-	-
	-10	6,006	6,442	6,754	7,439	8,301	-
	-5	4,923	5,531	5,837	6,282	7,274	8,189
	0	4,234	4,640	5,173	5,619	6,403	7,453
	5	3,643	4,004	4,309	4,953	5,672	6,463
	7	3,249	3,808	4,127	4,548	5,454	6,247
	10	3,052	3,491	3,816	4,241	4,909	5,890
	15	2,658	3,099	3,410	3,821	4,505	5,312
	20	2,363	2,731	3,026	3,430	4,069	4,769
	25	2,068	2,413	2,700	3,102	3,670	4,328
	30	1,674	2,099	2,375	2,778	3,271	3,892
35	1,378	1,776	2,053	2,444	2,880	3,450	

Capacity		Outlet Water Temp(°C)					
40% (28000W)		30	35	40	45	50	55
		Power Input(W)					
Outdoor Temp. (°C)	-30	-	-	-	-	-	-
	-25	17,877	18,749	-	-	-	-
	-20	16,275	17,146	18,416	-	-	-
	-15	13,194	13,838	14,230	15,205	-	-
	-10	11,225	12,079	12,476	13,166	15,059	-
	-5	9,354	9,968	10,641	11,340	12,916	14,943
	0	8,074	8,638	9,089	9,984	11,428	13,080
	5	6,597	7,411	7,852	8,512	10,037	11,568
	7	6,154	6,799	7,441	8,099	9,372	11,028
	10	5,612	6,218	6,661	7,500	8,721	10,111
	15	4,923	5,451	5,891	6,519	7,838	9,131
	20	4,135	4,694	5,135	5,737	6,784	8,175
	25	3,545	4,046	4,476	5,042	5,979	7,044
	30	2,855	3,399	3,812	4,346	5,172	5,910
35	2,265	2,751	3,165	3,655	4,378	4,779	

Notes:

1) Water flow rate of test condition : 200LPM

Air-Cooled Scroll Chiller (R410A)

5. Performance Data of Heating

Capacity		Outlet Water Temp(°C)					
60% (42000W)		30	35	40	45	50	55
		Power Input(W)					
Outdoor Temp. (°C)	-30	-	-	-	-	-	-
	-25	27,215	28,776	-	-	-	-
	-20	24,778	26,315	28,220	-	-	-
	-15	20,086	21,239	21,806	23,289	-	-
	-10	17,329	18,085	18,951	20,334	22,508	-
	-5	14,474	15,297	15,840	17,279	19,223	21,804
	0	12,111	13,112	13,667	14,816	16,766	19,116
	5	10,142	10,858	11,614	12,682	14,262	16,552
	7	9,354	10,393	10,938	11,942	13,734	15,772
	10	8,468	9,302	9,833	10,824	12,447	14,363
	15	7,483	8,110	8,727	9,666	11,008	12,957
	20	6,400	7,041	7,547	8,532	9,771	11,377
	25	5,415	6,092	6,593	7,438	8,676	10,159
	30	4,529	5,299	5,635	6,345	7,585	8,946
35	3,545	4,200	4,680	5,253	6,492	7,725	

Capacity		Outlet Water Temp(°C)					
80% (56000W)		30	35	40	45	50	55
		Power Input(W)					
Outdoor Temp. (°C)	-30	-	-	-	-	-	-
	-25	-	-	-	-	-	-
	-20	-	-	-	-	-	-
	-15	-	-	-	-	-	-
	-10	24,320	25,394	26,085	27,612	-	-
	-5	20,283	21,336	21,955	23,081	26,606	-
	0	17,526	18,331	19,014	20,028	22,938	26,432
	5	14,966	15,770	16,353	17,426	20,032	23,110
	7	13,883	14,850	15,428	16,378	18,985	21,909
	10	12,603	13,542	14,130	15,056	17,421	20,287
	15	10,929	11,686	12,385	13,296	15,477	17,998
	20	9,255	10,019	10,583	11,525	13,463	15,771
	25	7,778	8,632	9,182	9,995	11,846	13,886
	30	6,302	7,251	7,783	8,462	10,234	11,998
35	4,825	5,861	6,386	6,937	8,609	10,116	

Notes:

1) Water flow rate of test condition : 200LPM

Air-Cooled Scroll Chiller (R410A)

5. Performance Data of Heating

Capacity		Outlet Water Temp(°C)					
100% (70000W)		30	35	40	45	50	55
		Power Input(W)					
Outdoor Temp. (°C)	-30	-	-	-	-	-	-
	-25	-	-	-	-	-	-
	-20	-	-	-	-	-	-
	-15	-	-	-	-	-	-
	-10	-	-	-	-	-	-
	-5	26,239	29,071	30,400	31,534	-	-
	0	23,237	24,818	25,997	27,025	32,255	-
	5	19,594	21,013	22,148	22,921	27,572	31,921
	7	18,117	18,981	20,078	21,539	24,999	28,950
	10	16,837	18,009	18,945	19,751	23,627	27,478
	15	14,671	15,836	16,753	17,470	21,088	24,475
	20	12,406	13,603	14,485	15,216	18,403	21,567
	25	10,437	12,434	13,404	14,138	17,016	19,772
	30	8,468	11,037	12,289	13,023	15,883	18,457
35	6,597	9,847	10,991	11,658	13,650	17,369	

Notes:

1) Water flow rate of test condition : 200LPM

Air-Cooled Scroll Chiller (R410A)

5. Performance Data of Heating

■ ACHH023LBAB

Capacity		Outlet Water Temp(°C)					
20% (16400W)		30	35	40	45	50	55
		Power Input(W)					
Outdoor Temp. (°C)	-30	12,024	-	-	-	-	-
	-25	11,239	11,866	-	-	-	-
	-20	10,333	10,850	11,654	-	-	-
	-15	8,295	8,758	9,406	9,956	11,068	12,328
	-10	7,127	7,644	8,014	8,827	9,849	11,033
	-5	5,841	6,563	6,926	7,454	8,631	9,716
	0	5,024	5,505	6,138	6,667	7,597	8,843
	5	4,323	4,751	5,113	5,877	6,730	7,668
	7	3,855	4,519	4,897	5,396	6,471	7,412
	10	3,622	4,142	4,527	5,032	5,825	6,988
	15	3,154	3,677	4,046	4,533	5,346	6,303
	20	2,804	3,241	3,590	4,070	4,828	5,658
	25	2,453	2,863	3,204	3,680	4,354	5,136
	30	1,986	2,490	2,817	3,297	3,881	4,618
35	1,636	2,107	2,435	2,900	3,417	4,094	

Capacity		Outlet Water Temp(°C)					
40% (32800W)		30	35	40	45	50	55
		Power Input(W)					
Outdoor Temp. (°C)	-30	-	-	-	-	-	-
	-25	21,212	22,247	-	-	-	-
	-20	19,312	20,344	21,851	-	-	-
	-15	15,655	16,419	16,884	18,040	20,238	22,660
	-10	13,319	14,332	14,803	15,621	17,868	20,231
	-5	11,099	11,827	12,626	13,455	15,325	17,730
	0	9,580	10,249	10,785	11,846	13,559	15,520
	5	7,828	8,794	9,317	10,100	11,909	13,726
	7	7,302	8,068	8,829	9,610	11,120	13,084
	10	6,659	7,377	7,904	8,899	10,348	11,997
	15	5,841	6,468	6,990	7,734	9,300	10,835
	20	4,907	5,570	6,093	6,807	8,050	9,700
	25	4,206	4,801	5,311	5,982	7,094	8,357
	30	3,388	4,033	4,524	5,157	6,136	7,013
35	2,687	3,264	3,756	4,337	5,194	5,670	

Notes:

1) Water flow rate of test condition : 235LPM

Air-Cooled Scroll Chiller (R410A)

5. Performance Data of Heating

Capacity		Outlet Water Temp(°C)					
60% (49200W)		30	35	40	45	50	55
		Power Input(W)					
Outdoor Temp. (°C)	-30	-	-	-	-	-	-
	-25	32,292	34,145	-	-	-	-
	-20	29,400	31,224	33,485	-	-	-
	-15	23,833	25,200	25,873	27,633	30,942	34,942
	-10	20,562	21,458	22,485	24,126	26,706	30,754
	-5	17,174	18,150	18,794	20,501	22,808	25,870
	0	14,370	15,557	16,216	17,579	19,893	22,682
	5	12,033	12,883	13,780	15,047	16,922	19,639
	7	11,099	12,331	12,978	14,169	16,296	18,714
	10	10,047	11,037	11,666	12,843	14,768	17,042
	15	8,879	9,623	10,355	11,468	13,062	15,373
	20	7,594	8,354	8,955	10,123	11,593	13,499
	25	6,426	7,228	7,822	8,825	10,294	12,053
	30	5,374	6,447	6,685	7,528	8,999	10,614
	35	4,206	4,983	5,553	6,233	7,703	9,166

Capacity		Outlet Water Temp(°C)					
80% (65600W)		30	35	40	45	50	55
		Power Input(W)					
Outdoor Temp. (°C)	-30	-	-	-	-	-	-
	-25	-	-	-	-	-	-
	-20	-	-	-	-	-	-
	-15	-	-	-	-	-	-
	-10	28,857	30,130	30,951	32,762	-	-
	-5	24,067	25,315	26,050	27,386	31,569	-
	0	20,796	21,750	22,560	23,763	27,216	31,362
	5	17,758	18,712	19,403	20,676	23,769	27,420
	7	16,473	17,620	18,305	19,433	22,526	25,995
	10	14,954	16,068	16,765	17,864	20,671	24,071
	15	12,968	13,866	14,695	15,776	18,364	21,356
	20	10,982	11,888	12,556	13,675	15,974	18,712
	25	9,229	10,242	10,895	11,859	14,056	16,476
	30	7,477	8,603	9,234	10,041	12,143	14,236
	35	5,725	6,954	7,577	8,230	10,215	12,003

Notes:

1) Water flow rate of test condition : 235LPM

Air-Cooled Scroll Chiller (R410A)

5. Performance Data of Heating

Capacity		Outlet Water Temp(°C)					
100% (82000W)		30	35	40	45	50	55
		Power Input(W)					
Outdoor Temp. (°C)	-30	-	-	-	-	-	-
	-25	-	-	-	-	-	-
	-20	-	-	-	-	-	-
	-15	-	-	-	-	-	-
	-10	-	-	-	-	-	-
	-5	31,133	34,494	36,070	37,416	-	-
	0	27,572	29,447	30,846	32,066	38,271	-
	5	23,249	24,933	26,280	28,796	32,715	37,875
	7	21,497	22,521	23,822	27,333	29,661	34,349
	10	19,978	21,368	22,479	23,435	28,034	32,603
	15	17,408	18,790	19,878	20,729	25,022	29,040
	20	14,720	16,141	17,187	18,054	21,835	25,589
	25	12,384	13,548	15,635	16,505	19,921	23,190
	30	10,047	12,161	14,581	15,452	18,846	21,900
35	7,828	11,447	13,041	13,833	16,196	20,609	

Notes:

1) Water flow rate of test condition : 235LPM

Air-Cooled Scroll Chiller (R410A)

5. Performance Data of Heating

■ ACHH033LBAB

Capacity		Outlet Water Temp(°C)					
20% (24000 W)		30	35	40	45	50	55
		Power Input(W)					
Outdoor Temp. (°C)	-30	17,103	-	-	-	-	-
	-25	15,987	16,879	-	-	-	-
	-20	14,699	15,433	16,577	-	-	-
	-15	11,799	12,457	13,380	14,162	15,744	17,536
	-10	10,137	10,873	11,399	12,556	14,010	15,694
	-5	8,309	9,336	9,852	10,603	12,277	13,821
	0	7,146	7,831	8,731	9,484	10,807	12,578
	5	6,149	6,758	7,272	8,360	9,573	10,907
	7	5,484	6,428	6,966	7,675	9,204	10,543
	10	5,152	5,892	6,440	7,157	8,286	9,940
	15	4,487	5,231	5,755	6,448	7,604	8,966
	20	3,988	4,610	5,107	5,789	6,868	8,048
	25	3,490	4,073	4,557	5,235	6,194	7,305
	30	2,825	3,542	4,008	4,689	5,520	6,569
35	2,327	2,997	3,464	4,126	4,860	5,823	

Capacity		Outlet Water Temp(°C)					
40% (48000 W)		30	35	40	45	50	55
		Power Input(W)					
Outdoor Temp. (°C)	-30	-	-	-	-	-	-
	-25	30,172	31,645	-	-	-	-
	-20	27,469	28,938	31,082	-	-	-
	-15	22,268	23,356	24,017	25,662	28,788	32,233
	-10	18,945	20,387	21,056	22,221	25,417	28,778
	-5	15,787	16,824	17,960	19,140	21,799	25,220
	0	13,627	14,579	15,341	16,851	19,288	22,077
	5	11,134	12,509	13,253	14,367	16,940	19,525
	7	10,386	11,476	12,559	13,670	15,817	18,612
	10	9,472	10,494	11,242	12,658	14,720	17,065
	15	8,309	9,200	9,942	11,002	13,229	15,412
	20	6,980	7,923	8,667	9,683	11,450	13,798
	25	5,983	6,829	7,554	8,510	10,091	11,888
	30	4,819	5,737	6,435	7,336	8,729	9,975
35	3,822	4,643	5,343	6,169	7,389	8,065	

Notes:

1) Water flow rate of test condition : 345LPM

Air-Cooled Scroll Chiller (R410A)

5. Performance Data of Heating

Capacity		Outlet Water Temp(°C)					
60% (72000 W)		30	35	40	45	50	55
		Power Input(W)					
Outdoor Temp. (°C)	-30	-	-	-	-	-	-
	-25	45,934	48,568	-	-	-	-
	-20	41,819	44,414	47,630	-	-	-
	-15	33,901	35,846	36,804	39,307	44,013	49,704
	-10	29,248	30,524	31,984	34,319	37,989	43,746
	-5	24,429	25,818	26,734	29,162	32,443	36,800
	0	20,440	22,130	23,067	25,006	28,297	32,264
	5	17,117	18,325	19,602	21,404	24,071	27,936
	7	15,787	17,541	18,461	20,155	23,181	26,620
	10	14,292	15,699	16,595	18,269	21,007	24,242
	15	12,630	13,688	14,730	16,313	18,580	21,868
	20	10,802	11,883	12,738	14,400	16,491	19,202
	25	9,140	10,282	11,127	12,553	14,643	17,146
	30	7,644	9,110	9,510	10,708	12,801	15,098
35	5,983	7,088	7,899	8,867	10,958	13,039	

Capacity		Outlet Water Temp(°C)					
80% (96000 W)		30	35	40	45	50	55
		Power Input(W)					
Outdoor Temp. (°C)	-30	-	-	-	-	-	-
	-25	-	-	-	-	-	-
	-20	-	-	-	-	-	-
	-15	49,854	-	-	-	-	-
	-10	41,047	42,859	44,026	46,603	-	-
	-5	34,233	36,010	37,055	38,955	44,905	-
	0	29,580	30,939	32,091	33,803	38,714	44,611
	5	25,260	26,617	27,600	29,411	33,810	39,004
	7	23,432	25,064	26,039	27,643	32,043	36,977
	10	21,271	22,856	23,848	25,411	29,403	34,241
	15	18,446	19,723	20,903	22,441	26,123	30,377
	20	15,621	16,910	17,861	19,452	22,723	26,618
	25	13,128	14,569	15,497	16,869	19,994	23,436
	30	10,636	12,238	13,135	14,282	17,273	20,250
35	8,143	9,892	10,778	11,707	14,530	17,073	

Notes:

1) Water flow rate of test condition : 345LPM

Air-Cooled Scroll Chiller (R410A)

5. Performance Data of Heating

Capacity		Outlet Water Temp(°C)					
100% (120000 W)		30	35	40	45	50	55
		Power Input(W)					
Outdoor Temp. (°C)	-30	-	-	-	-	-	-
	-25	-	-	-	-	-	-
	-20	-	-	-	-	-	-
	-15	-	-	-	-	-	-
	-10	-	-	-	-	-	-
	-5	44,936	49,787	52,062	54,006	-	-
	0	39,796	42,503	44,522	46,283	55,239	-
	5	33,556	35,987	37,931	39,254	47,220	54,667
	7	31,027	32,507	34,385	35,294	42,812	49,579
	10	28,835	30,842	32,446	33,826	40,463	47,059
	15	25,125	27,121	28,692	29,919	36,116	41,916
	20	21,247	23,297	24,807	26,059	31,517	36,935
	25	17,874	20,585	23,277	24,533	29,463	34,183
	30	14,502	18,902	21,046	22,303	27,201	31,609
35	11,298	16,522	18,824	19,966	23,377	29,328	

Notes:

1) Water flow rate of test condition : 345LPM

Air-Cooled Scroll Chiller (R410A)

5. Performance Data of Heating

■ ACHH040LBAB

Capacity		Outlet Water Temp(°C)					
20% (28000 W)		30	35	40	45	50	55
		Power Input(W)					
Outdoor Temp. (°C)	-30	20,267	-	-	-	-	-
	-25	18,944	20,001	-	-	-	-
	-20	17,418	18,288	19,643	-	-	-
	-15	13,982	14,762	15,855	16,781	-	-
	-10	12,012	12,884	13,508	14,878	16,601	-
	-5	9,846	11,063	11,674	12,564	14,548	16,378
	0	8,468	9,279	10,346	11,238	12,806	14,905
	5	7,286	8,008	8,618	9,906	11,344	12,925
	7	6,498	7,617	8,254	9,095	10,907	12,493
	10	6,105	6,982	7,631	8,481	9,819	11,779
	15	5,317	6,199	6,819	7,641	9,011	10,624
	20	4,726	5,463	6,052	6,860	8,138	9,537
	25	4,135	4,826	5,400	6,204	7,340	8,657
	30	3,348	4,198	4,749	5,557	6,542	7,785
35	2,757	3,552	4,105	4,889	5,760	6,900	

Capacity		Outlet Water Temp(°C)					
40% (56000 W)		30	35	40	45	50	55
		Power Input(W)					
Outdoor Temp. (°C)	-30	-	-	-	-	-	-
	-25	35,754	37,499	-	-	-	-
	-20	32,551	34,291	36,832	-	-	-
	-15	26,388	27,676	28,460	30,409	-	-
	-10	22,449	24,158	24,952	26,331	30,119	-
	-5	18,708	19,936	21,282	22,681	25,831	29,886
	0	16,148	17,276	18,178	19,968	22,856	26,161
	5	13,194	14,823	15,704	17,024	20,074	23,137
	7	12,308	13,599	14,883	16,199	18,743	22,055
	10	11,225	12,435	13,322	15,000	17,443	20,222
	15	9,846	10,902	11,782	13,037	15,676	18,263
	20	8,271	9,389	10,270	11,474	13,569	16,350
	25	7,089	8,093	8,951	10,084	11,958	14,087
	30	5,711	6,798	7,625	8,693	10,343	11,821
35	4,529	5,502	6,331	7,310	8,756	9,557	

Notes:

1) Water flow rate of test condition : 400 LPM

Air-Cooled Scroll Chiller (R410A)

5. Performance Data of Heating

Capacity		Outlet Water Temp(°C)					
60% (84000 W)		30	35	40	45	50	55
		Power Input(W)					
Outdoor Temp. (°C)	-30	-	-	-	-	-	-
	-25	54,431	57,553	-	-	-	-
	-20	49,555	52,630	56,441	-	-	-
	-15	40,172	42,477	43,612	46,579	-	-
	-10	34,658	36,170	37,901	40,667	45,016	-
	-5	28,948	30,594	31,680	34,557	38,445	43,607
	0	24,222	26,223	27,334	29,632	33,532	38,233
	5	20,283	21,715	23,228	25,364	28,524	33,104
	7	18,708	20,786	21,876	23,884	27,469	31,544
	10	16,935	18,603	19,665	21,648	24,893	28,726
	15	14,966	16,220	17,455	19,331	22,017	25,913
	20	12,800	14,081	15,095	17,064	19,541	22,754
	25	10,831	12,184	13,185	14,876	17,352	20,317
	30	9,058	10,598	11,269	12,689	15,169	17,891
	35	7,089	8,399	9,360	10,507	12,985	15,451

Capacity		Outlet Water Temp(°C)					
80% (112000 W)		30	35	40	45	50	55
		Power Input(W)					
Outdoor Temp. (°C)	-30	-	-	-	-	-	-
	-25	-	-	-	-	-	-
	-20	-	-	-	-	-	-
	-15	-	-	-	-	-	-
	-10	48,640	50,788	52,171	55,224	-	-
	-5	40,566	42,672	43,910	46,161	53,212	-
	0	35,052	36,662	38,028	40,056	45,875	52,864
	5	29,932	31,540	32,706	34,852	40,065	46,220
	7	27,766	29,700	30,856	32,756	37,970	43,817
	10	25,206	27,084	28,259	30,112	34,843	40,575
	15	21,858	23,372	24,770	26,592	30,955	35,997
	20	18,511	20,038	21,165	23,051	26,926	31,542
	25	15,557	17,264	18,364	19,990	23,692	27,772
	30	12,603	14,501	15,565	16,924	20,468	23,996
	35	9,649	11,722	12,772	13,873	17,218	20,232

Notes:

1) Water flow rate of test condition : 400 LPM

Air-Cooled Scroll Chiller (R410A)

5. Performance Data of Heating

Capacity		Outlet Water Temp(°C)					
100% (140000 W)		30	35	40	45	50	55
		Power Input(W)					
Outdoor Temp. (°C)	-30	-	-	-	-	-	-
	-25	-	-	-	-	-	-
	-20	-	-	-	-	-	-
	-15	-	-	-	-	-	-
	-10	-	-	-	-	-	-
	-5	52,477	58,143	60,799	63,069	-	-
	0	46,474	49,635	51,994	54,051	64,509	-
	5	39,188	42,027	44,297	45,841	55,144	63,842
	7	36,234	37,962	40,155	43,078	49,997	57,900
	10	33,674	36,017	37,890	39,502	47,254	54,956
	15	29,342	31,673	33,507	34,940	42,177	48,950
	20	24,812	27,207	28,970	30,432	36,806	43,133
	25	20,874	24,868	26,809	28,276	34,033	39,545
	30	16,935	22,074	24,578	26,045	31,766	36,914
35	13,194	19,695	21,983	23,316	27,301	34,738	

Notes:

1) Water flow rate of test condition : 400 LPM

Air-Cooled Scroll Chiller (R410A)

5. Performance Data of Heating

■ ACHH045LBAB

Capacity		Outlet Water Temp(°C)					
20% (32800W)		30	35	40	45	50	55
		Power Input(W)					
Outdoor Temp. (°C)	-30	24,048	-	-	-	-	-
	-25	22,478	23,732	-	-	-	-
	-20	20,667	21,700	23,308	-	-	-
	-15	16,590	17,515	18,813	19,911	22,137	24,656
	-10	14,253	15,287	16,027	17,653	19,698	22,066
	-5	11,683	13,126	13,852	14,907	17,261	19,432
	0	10,047	11,010	12,276	13,334	15,195	17,685
	5	8,645	9,501	10,225	11,754	13,459	15,336
	7	7,711	9,038	9,794	10,792	12,941	14,824
	10	7,243	8,285	9,055	10,063	11,650	13,976
	15	6,309	7,355	8,091	9,066	10,691	12,606
	20	5,608	6,482	7,181	8,140	9,656	11,316
	25	4,907	5,726	6,408	7,361	8,709	10,272
	30	3,972	4,981	5,635	6,593	7,762	9,237
35	3,271	4,214	4,871	5,801	6,834	8,187	

Capacity		Outlet Water Temp(°C)					
40% (65600W)		30	35	40	45	50	55
		Power Input(W)					
Outdoor Temp. (°C)	-30	-	-	-	-	-	-
	-25	42,423	44,494	-	-	-	-
	-20	38,623	40,688	43,702	-	-	-
	-15	31,310	32,838	33,768	36,081	40,477	45,320
	-10	26,637	28,664	29,606	31,243	35,737	40,462
	-5	22,198	23,655	25,252	26,911	30,649	35,460
	0	19,160	20,498	21,569	23,692	27,118	31,040
	5	15,655	17,587	18,634	20,200	23,818	27,452
	7	14,604	16,135	17,658	19,220	22,239	26,169
	10	13,319	14,755	15,807	17,798	20,696	23,994
	15	11,683	12,936	13,979	15,469	18,600	21,669
	20	9,814	11,140	12,186	13,615	16,099	19,400
	25	8,412	9,602	10,621	11,965	14,189	16,715
	30	6,776	8,066	9,047	10,314	12,273	14,025
35	5,374	6,528	7,512	8,673	10,389	11,340	

Notes:

1) Water flow rate of test condition : 470 LPM

Air-Cooled Scroll Chiller (R410A)

5. Performance Data of Heating

Capacity		Outlet Water Temp(°C)					
60% (98400W)		30	35	40	45	50	55
		Power Input(W)					
Outdoor Temp. (°C)	-30	-	-	-	-	-	-
	-25	64,585	68,289	-	-	-	-
	-20	58,799	62,448	66,969	-	-	-
	-15	47,666	50,400	51,746	55,267	61,883	69,884
	-10	41,124	42,917	44,971	48,252	53,413	61,508
	-5	34,348	36,301	37,589	41,003	45,616	51,741
	0	28,740	31,114	32,433	35,158	39,786	45,364
	5	24,067	25,766	27,561	30,095	33,844	39,278
	7	22,198	24,663	25,956	28,339	32,592	37,428
	10	20,095	22,073	23,333	25,686	29,536	34,085
	15	17,758	19,245	20,710	22,937	26,123	30,746
	20	15,188	16,708	17,910	20,247	23,186	26,998
	25	12,851	14,457	15,644	17,650	20,588	24,107
	30	10,748	12,894	13,371	15,056	17,999	21,229
35	8,412	9,966	11,106	12,466	15,407	18,333	

Capacity		Outlet Water Temp(°C)					
80% (131200W)		30	35	40	45	50	55
		Power Input(W)					
Outdoor Temp. (°C)	-30	-	-	-	-	-	-
	-25	-	-	-	-	-	-
	-20	-	-	-	-	-	-
	-15	-	-	-	-	-	-
	-10	57,714	60,261	61,902	65,524	-	-
	-5	48,134	50,631	52,100	54,771	63,137	-
	0	41,591	43,500	45,120	47,527	54,432	62,724
	5	35,516	37,423	38,806	41,353	47,538	54,840
	7	32,946	35,240	36,611	38,866	45,052	51,990
	10	29,908	32,136	33,530	35,728	41,342	48,143
	15	25,936	27,731	29,390	31,552	36,729	42,711
	20	21,964	23,776	25,113	27,350	31,949	37,425
	25	18,459	20,484	21,789	23,718	28,111	32,952
	30	14,954	17,206	18,468	20,081	24,286	28,471
35	11,449	13,909	15,154	16,461	20,429	24,005	

Notes:

1) Water flow rate of test condition : 470 LPM

Air-Cooled Scroll Chiller (R410A)

5. Performance Data of Heating

Capacity		Outlet Water Temp(°C)					
100% (164000W)		30	35	40	45	50	55
		Power Input(W)					
Outdoor Temp. (°C)	-30	-	-	-	-	-	-
	-25	-	-	-	-	-	-
	-20	-	-	-	-	-	-
	-15	-	-	-	-	-	-
	-10	-	-	-	-	-	-
	-5	62,266	68,987	72,139	74,832	-	-
	0	55,143	58,893	61,692	64,132	76,542	-
	5	46,498	49,865	52,559	57,591	65,429	75,749
	7	42,993	45,043	47,645	54,667	59,322	68,699
	10	39,956	42,735	44,958	46,870	56,067	65,207
	15	34,815	37,580	39,756	41,457	50,044	58,080
	20	29,441	32,281	34,374	36,108	43,670	51,178
	25	24,768	27,096	31,269	33,010	39,841	46,381
	30	20,095	24,321	29,162	30,903	37,691	43,799
35	15,655	22,893	26,083	27,665	32,393	41,218	

Notes:

1) Water flow rate of test condition : 470 LPM

Air-Cooled Scroll Chiller (R410A)

5. Performance Data of Heating

■ ACHH050LBAB

Capacity		Outlet Water Temp(°C)					
20% (36000W)		30	35	40	45	50	55
		Power Input(W)					
Outdoor Temp. (°C)	-30	25,655	-	-	-	-	-
	-25	23,980	25,318	-	-	-	-
	-20	22,048	23,150	24,865	-	-	-
	-15	17,698	18,686	20,070	21,243	23,617	26,304
	-10	15,206	16,309	17,099	18,833	21,015	23,541
	-5	12,464	14,003	14,778	15,904	18,415	20,731
	0	10,719	11,746	13,097	14,226	16,210	18,868
	5	9,223	10,137	10,909	12,539	14,359	16,361
	7	8,226	9,642	10,448	11,513	13,807	15,815
	10	7,727	8,839	9,660	10,736	12,429	14,910
	15	6,730	7,846	8,632	9,672	11,406	13,448
	20	5,983	6,915	7,661	8,684	10,301	12,073
	25	5,235	6,109	6,836	7,853	9,291	10,958
	30	4,238	5,313	6,012	7,034	8,281	9,854
35	3,490	4,496	5,196	6,189	7,291	8,734	

Capacity		Outlet Water Temp(°C)					
40% (72000W)		30	35	40	45	50	55
		Power Input(W)					
Outdoor Temp. (°C)	-30	-	-	-	-	-	-
	-25	45,258	47,467	-	-	-	-
	-20	41,204	43,407	46,623	-	-	-
	-15	33,402	35,034	36,026	38,493	43,182	48,349
	-10	28,417	30,580	31,585	33,331	38,125	43,166
	-5	23,681	25,236	26,940	28,710	32,698	37,831
	0	20,440	21,869	23,011	25,276	28,931	33,115
	5	16,701	18,763	19,879	21,550	25,410	29,288
	7	15,579	17,214	18,839	20,505	23,726	27,918
	10	14,209	15,741	16,864	18,987	22,080	25,598
	15	12,464	13,800	14,914	16,503	19,844	23,118
	20	10,469	11,884	13,000	14,525	17,176	20,697
	25	8,974	10,244	11,331	12,764	15,137	17,832
	30	7,229	8,605	9,652	11,003	13,093	14,963
35	5,733	6,964	8,014	9,253	11,083	12,098	

Notes:

1) Water flow rate of test condition : 518 LPM

Air-Cooled Scroll Chiller (R410A)

5. Performance Data of Heating

Capacity		Outlet Water Temp(°C)					
60% (108000W)		30	35	40	45	50	55
		Power Input(W)					
Outdoor Temp. (°C)	-30	-	-	-	-	-	-
	-25	68,900	72,853	-	-	-	-
	-20	62,729	66,621	71,445	-	-	-
	-15	50,851	53,769	55,206	58,961	66,020	74,555
	-10	43,872	45,785	47,977	51,478	56,983	65,619
	-5	36,643	38,727	40,102	43,744	48,665	55,199
	0	30,660	33,194	34,601	37,509	42,445	48,396
	5	25,675	27,488	29,403	32,107	36,106	41,904
	7	23,681	26,311	27,691	30,233	34,771	39,930
	10	21,437	23,549	24,893	27,403	31,511	36,363
	15	18,945	20,532	22,095	24,470	27,870	32,802
	20	16,203	17,824	19,108	21,600	24,736	28,803
	25	13,710	15,423	16,690	18,830	21,965	25,718
	30	11,467	13,665	14,265	16,063	19,202	22,648
35	8,974	10,632	11,849	13,300	16,437	19,558	

Capacity		Outlet Water Temp(°C)					
80% (144000W)		30	35	40	45	50	55
		Power Input(W)					
Outdoor Temp. (°C)	-30	-	-	-	-	-	-
	-25	-	-	-	-	-	-
	-20	-	-	-	-	-	-
	-15	74,782	-	-	-	-	-
	-10	61,570	64,289	66,040	69,904	-	-
	-5	51,350	54,015	55,582	58,432	67,358	-
	0	44,370	46,408	48,137	50,704	58,070	66,917
	5	37,889	39,925	41,400	44,117	50,715	58,506
	7	35,147	37,596	39,058	41,464	48,064	55,466
	10	31,907	34,284	35,771	38,117	44,105	51,361
	15	27,669	29,585	31,354	33,661	39,184	45,566
	20	23,432	25,365	26,792	29,179	34,084	39,927
	25	19,692	21,853	23,246	25,304	29,990	35,154
	30	15,953	18,356	19,703	21,423	25,909	30,375
35	12,214	14,838	16,167	17,561	21,795	25,610	

Notes:

1) Water flow rate of test condition : 518 LPM

Air-Cooled Scroll Chiller (R410A)

5. Performance Data of Heating

Capacity		Outlet Water Temp(°C)					
100% (180000W)		30	35	40	45	50	55
		Power Input(W)					
Outdoor Temp. (°C)	-30	-	-	-	-	-	-
	-25	-	-	-	-	-	-
	-20	-	-	-	-	-	-
	-15	-	-	-	-	-	-
	-10	-	-	-	-	-	-
	-5	67,404	74,681	78,093	81,009	-	-
	0	59,693	63,754	66,784	69,425	82,859	-
	5	50,335	53,981	56,897	58,881	70,829	82,001
	7	46,541	48,761	51,577	52,941	64,219	74,369
	10	43,252	46,263	48,668	50,738	60,695	70,588
	15	37,688	40,682	43,037	44,879	54,174	62,874
	20	31,870	34,946	37,211	39,088	47,275	55,402
	25	26,811	30,877	34,915	36,800	44,194	51,274
	30	21,753	28,353	31,569	33,454	40,802	47,414
35	16,947	24,783	28,236	29,948	35,066	43,993	

Notes:

1) Water flow rate of test condition : 518 LPM

Air-Cooled Scroll Chiller (R410A)

5. Performance Data of Heating

■ ACHH060LBAB

Capacity		Outlet Water Temp(°C)					
20% (42000W)		30	35	40	45	50	55
		Power Input(W)					
Outdoor Temp. (°C)	-30	30,401	-	-	-	-	-
	-25	28,416	30,002	-	-	-	-
	-20	26,126	27,433	29,465	-	-	-
	-15	20,972	22,143	23,783	25,172	-	-
	-10	18,018	19,326	20,262	22,317	24,902	-
	-5	14,769	16,594	17,511	18,846	21,822	24,566
	0	12,702	13,919	15,519	16,857	19,209	22,358
	5	10,929	12,012	12,927	14,859	17,015	19,388
	7	9,748	11,425	12,381	13,643	16,361	18,740
	10	9,157	10,474	11,447	12,722	14,728	17,669
	15	7,975	9,298	10,229	11,462	13,516	15,936
	20	7,089	8,194	9,078	10,291	12,207	14,306
	25	6,203	7,239	8,101	9,306	11,009	12,985
	30	5,022	6,296	7,124	8,335	9,812	11,677
35	4,135	5,327	6,158	7,333	8,639	10,350	

Capacity		Outlet Water Temp(°C)					
40% (84000W)		30	35	40	45	50	55
		Power Input(W)					
Outdoor Temp. (°C)	-30	-	-	-	-	-	-
	-25	53,630	56,248	-	-	-	-
	-20	48,826	51,437	55,247	-	-	-
	-15	39,582	41,514	42,690	45,614	-	-
	-10	33,674	36,237	37,427	39,497	45,178	-
	-5	28,062	29,905	31,924	34,021	38,747	44,829
	0	24,222	25,914	27,268	29,952	34,283	39,241
	5	19,791	22,234	23,557	25,537	30,111	34,705
	7	18,462	20,398	22,324	24,298	28,115	33,083
	10	16,837	18,653	19,983	22,500	26,164	30,333
	15	14,769	16,353	17,672	19,556	23,514	27,394
	20	12,406	14,083	15,405	17,212	20,353	24,525
	25	10,634	12,139	13,427	15,126	17,937	21,131
	30	8,566	10,197	11,437	13,039	15,515	17,731
35	6,794	8,252	9,496	10,965	13,133	14,336	

Notes:

1) Water flow rate of test condition : 600 LPM

Air-Cooled Scroll Chiller (R410A)

5. Performance Data of Heating

Capacity		Outlet Water Temp(°C)					
60% (126000W)		30	35	40	45	50	55
		Power Input(W)					
Outdoor Temp. (°C)	-30	-	-	-	-	-	-
	-25	81,646	86,329	-	-	-	-
	-20	74,333	78,945	84,661	-	-	-
	-15	60,258	63,716	65,418	69,868	-	-
	-10	51,988	54,255	56,852	61,001	67,525	-
	-5	43,422	45,891	47,520	51,836	57,668	65,411
	0	36,332	39,335	41,002	44,447	50,297	57,349
	5	30,425	32,573	34,842	38,046	42,785	49,656
	7	28,062	31,179	32,814	35,826	41,203	47,316
	10	25,403	27,905	29,498	32,472	37,340	43,090
	15	22,449	24,330	26,182	28,997	33,025	38,870
	20	19,200	21,122	22,642	25,596	29,312	34,131
	25	16,246	18,276	19,778	22,313	26,028	30,476
	30	13,588	15,897	16,904	19,034	22,754	26,837
35	10,634	12,599	14,041	15,760	19,477	23,176	

Capacity		Outlet Water Temp(°C)					
80% (168000W)		30	35	40	45	50	55
		Power Input(W)					
Outdoor Temp. (°C)	-30	-	-	-	-	-	-
	-25	-	-	-	-	-	-
	-20	-	-	-	-	-	-
	-15	-	-	-	-	-	-
	-10	72,960	76,182	78,256	82,835	-	-
	-5	60,849	64,007	65,865	69,242	79,818	-
	0	52,578	54,993	57,041	60,084	68,813	79,296
	5	44,898	47,311	49,058	52,278	60,097	69,329
	7	41,649	44,551	46,284	49,135	56,955	65,726
	10	37,809	40,627	42,389	45,168	52,264	60,862
	15	32,788	35,058	37,154	39,888	46,432	53,995
	20	27,766	30,058	31,748	34,576	40,390	47,313
	25	23,335	25,896	27,546	29,985	35,538	41,658
	30	18,905	21,752	23,348	25,386	30,702	35,994
35	14,474	17,583	19,158	20,810	25,827	30,347	

Notes:

1) Water flow rate of test condition : 600 LPM

Air-Cooled Scroll Chiller (R410A)

5. Performance Data of Heating

Capacity		Outlet Water Temp(°C)					
100% (210000W)		30	35	40	45	50	55
		Power Input(W)					
Outdoor Temp. (°C)	-30	-	-	-	-	-	-
	-25	-	-	-	-	-	-
	-20	-	-	-	-	-	-
	-15	-	-	-	-	-	-
	-10	-	-	-	-	-	-
	-5	78,716	87,214	91,199	94,603	-	-
	0	69,711	74,453	77,991	81,076	96,764	-
	5	58,782	63,040	66,445	68,762	82,716	95,762
	7	54,351	56,943	60,233	64,617	74,996	86,849
	10	50,511	54,026	56,836	59,253	70,880	82,434
	15	44,012	47,509	50,260	52,410	63,265	73,425
	20	37,218	40,810	43,456	45,648	55,208	64,700
	25	31,311	37,301	40,213	42,414	51,049	59,317
	30	25,403	33,111	36,867	39,068	47,649	55,371
35	19,791	29,542	32,974	34,974	40,951	52,108	

Notes:

1) Water flow rate of test condition : 600 LPM

Air-Cooled Scroll Chiller (R410A)

5. Performance Data of Heating

■ ACHH067LBAB

Capacity		Outlet Water Temp(°C)					
20% (49200W)		30	35	40	45	50	55
		Power Input(W)					
Outdoor Temp. (°C)	-30	36,072	-	-	-	-	-
	-25	33,717	35,598	-	-	-	-
	-20	31,000	32,550	34,961	-	-	-
	-15	24,885	26,273	28,219	29,867	33,205	36,984
	-10	21,380	22,931	24,041	26,480	29,547	33,099
	-5	17,524	19,689	20,778	22,361	25,892	29,149
	0	15,071	16,515	18,414	20,001	22,792	26,528
	5	12,968	14,252	15,338	17,631	20,189	23,004
	7	11,566	13,556	14,691	16,188	19,412	22,236
	10	10,865	12,427	13,582	15,095	17,475	20,964
	15	9,463	11,032	12,137	13,599	16,037	18,909
	20	8,412	9,723	10,771	12,210	14,484	16,974
	25	7,360	8,589	9,612	11,041	13,063	15,407
	30	5,958	7,471	8,452	9,890	11,643	13,855
35	4,907	6,321	7,306	8,701	10,251	12,281	

Capacity		Outlet Water Temp(°C)					
40% (98400W)		30	35	40	45	50	55
		Power Input(W)					
Outdoor Temp. (°C)	-30	-	-	-	-	-	-
	-25	63,635	66,741	-	-	-	-
	-20	57,935	61,032	65,554	-	-	-
	-15	46,965	49,258	50,652	54,121	60,715	67,979
	-10	39,956	42,996	44,408	46,864	53,605	60,692
	-5	33,296	35,482	37,878	40,366	45,974	53,190
	0	28,740	30,747	32,354	35,539	40,678	46,560
	5	23,483	26,381	27,950	30,300	35,727	41,179
	7	21,905	24,203	26,488	28,830	33,359	39,253
	10	19,978	22,132	23,711	26,696	31,044	35,991
	15	17,524	19,404	20,969	23,203	27,900	32,504
	20	14,720	16,710	18,279	20,422	24,149	29,100
	25	12,618	14,403	15,932	17,947	21,283	25,072
	30	10,164	12,098	13,571	15,471	18,409	21,038
35	8,061	9,792	11,268	13,010	15,583	17,010	

Notes:

1) Water flow rate of test condition : 705 LPM

Air-Cooled Scroll Chiller (R410A)

5. Performance Data of Heating

Capacity		Outlet Water Temp(°C)					
60% (147600W)		30	35	40	45	50	55
		Power Input(W)					
Outdoor Temp. (°C)	-30	-	-	-	-	-	-
	-25	96,877	102,434	-	-	-	-
	-20	88,199	93,672	100,454	-	-	-
	-15	71,499	75,600	77,620	82,900	92,825	104,826
	-10	61,686	64,375	67,456	72,379	80,119	92,262
	-5	51,522	54,451	56,383	61,504	68,424	77,611
	0	43,110	46,672	48,649	52,738	59,679	68,046
	5	36,100	38,649	41,341	45,142	50,766	58,918
	7	33,296	36,994	38,934	42,508	48,889	56,142
	10	30,142	33,110	34,999	38,529	44,305	51,127
	15	26,637	28,868	31,065	34,405	39,185	46,120
	20	22,782	25,061	26,866	30,370	34,779	40,497
	25	19,277	21,685	23,467	26,475	30,882	36,160
	30	16,122	19,341	20,056	22,584	26,998	31,843
35	12,618	14,949	16,659	18,700	23,110	27,499	

Capacity		Outlet Water Temp(°C)					
80% (196800)		30	35	40	45	50	55
		Power Input(W)					
Outdoor Temp. (°C)	-30	-	-	-	-	-	-
	-25	-	-	-	-	-	-
	-20	-	-	-	-	-	-
	-15	-	-	-	-	-	-
	-10	86,570	90,391	92,852	98,286	-	-
	-5	72,200	75,946	78,150	82,157	94,706	-
	0	62,387	65,250	67,681	71,290	81,648	94,086
	5	53,274	56,135	58,209	62,029	71,306	82,261
	7	49,419	52,860	54,916	58,299	67,578	77,985
	10	44,862	48,204	50,295	53,592	62,012	72,214
	15	38,904	41,597	44,084	47,328	55,093	64,067
	20	32,946	35,664	37,669	41,025	47,923	56,137
	25	27,688	30,726	32,684	35,577	42,167	49,427
	30	22,431	25,809	27,703	30,122	36,428	42,707
35	17,174	20,863	22,731	24,691	30,644	36,008	

Notes:

1) Water flow rate of test condition : 705 LPM

Air-Cooled Scroll Chiller (R410A)

5. Performance Data of Heating

Capacity		Outlet Water Temp(°C)					
100% (246000W)		30	35	40	45	50	55
		Power Input(W)					
Outdoor Temp. (°C)	-30	-	-	-	-	-	-
	-25	-	-	-	-	-	-
	-20	-	-	-	-	-	-
	-15	-	-	-	-	-	-
	-10	-	-	-	-	-	-
	-5	93,400	103,481	108,209	112,248	-	-
	0	82,715	88,340	92,538	96,198	114,812	-
	5	69,747	74,798	78,839	86,387	98,144	113,624
	7	64,490	67,564	71,467	82,000	88,984	103,048
	10	59,933	64,103	67,437	70,305	84,101	97,810
	15	52,223	56,371	59,634	62,186	75,065	87,120
	20	44,161	48,422	51,561	54,162	65,506	76,767
	25	37,152	40,644	46,904	49,516	59,762	69,571
	30	30,142	36,482	43,743	46,355	56,537	65,699
35	23,483	34,340	39,124	41,498	48,589	61,827	

Notes:

1) Water flow rate of test condition : 705 LPM

6. Head loss of Cold water

■ **ACHH Series evaporator head loss graph**

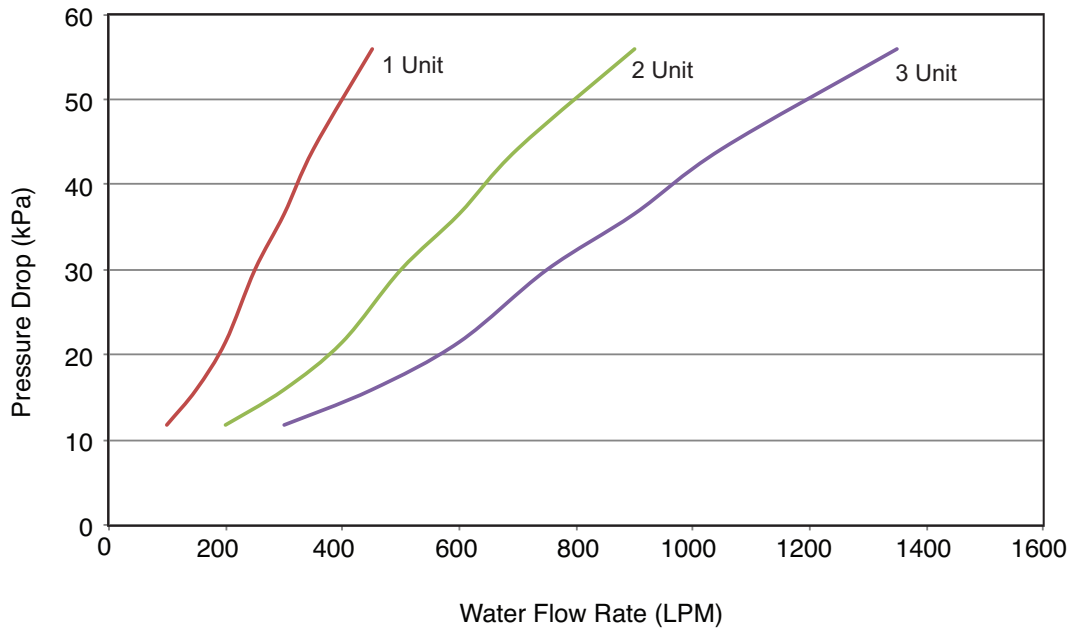

Air-Cooled Scroll Chiller (R410A)

7. Dimensions

■ 1 Unit

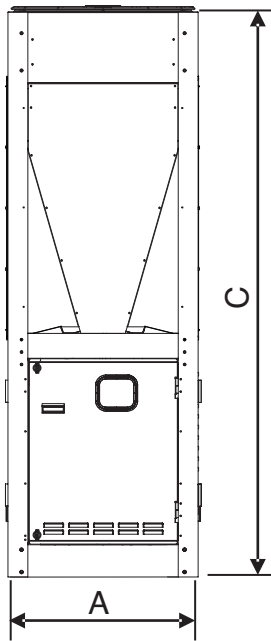

- Front view -

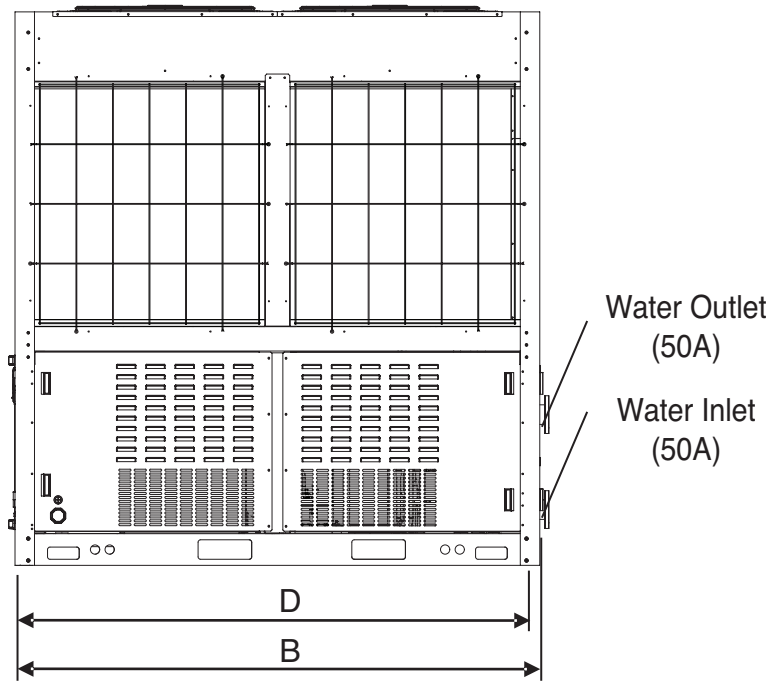

- Side view -

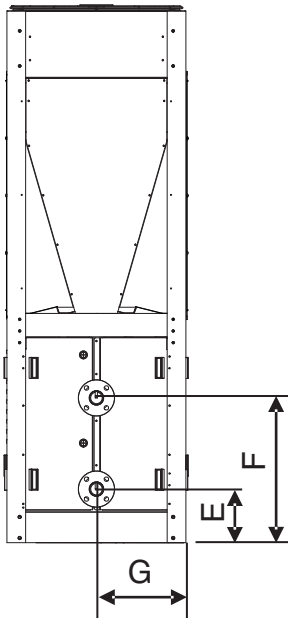

- Rear view -

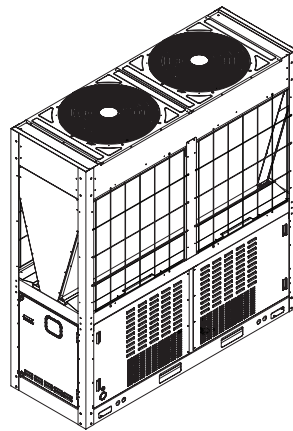

(Unit: mm)

Classification	Dimension
A	765
B	2,198
C	2,300
D	2,154
E	230
F	619
G	382.3

Air-Cooled Scroll Chiller (R410A)

7. Dimensions

■ 2 Unit

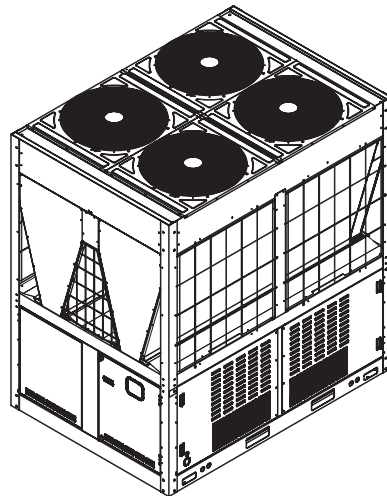
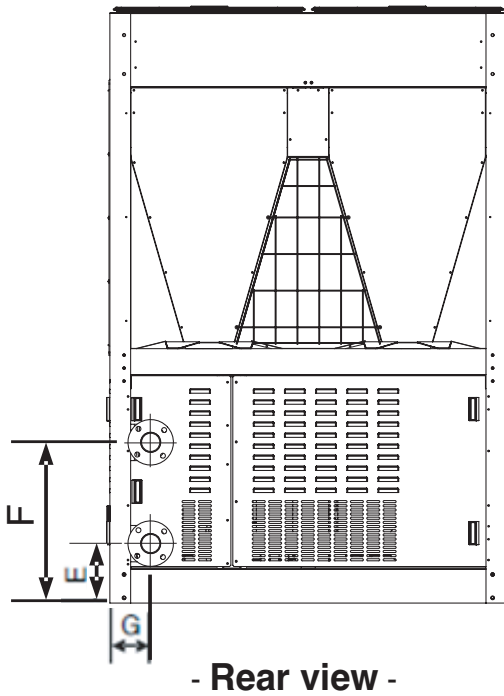
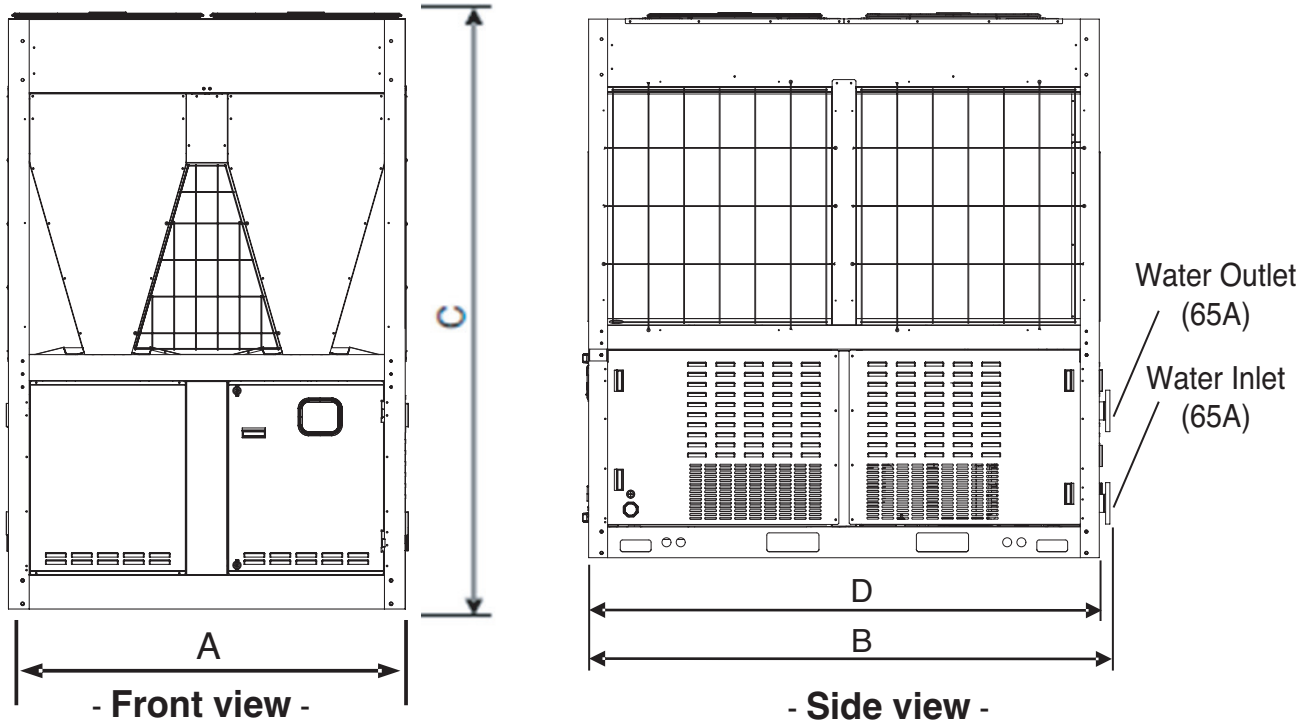

(Unit : mm)

Classification	Dimension
A	1,528
B	2,199
C	2,300
D	2,154
E	230
F	619
G	158.8

Air-Cooled Scroll Chiller (R410A)

7. Dimensions

■ 3 Unit

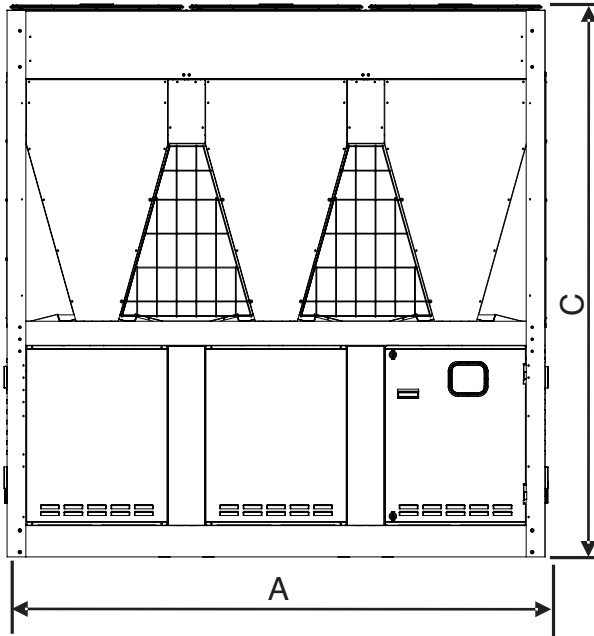

- Front view -

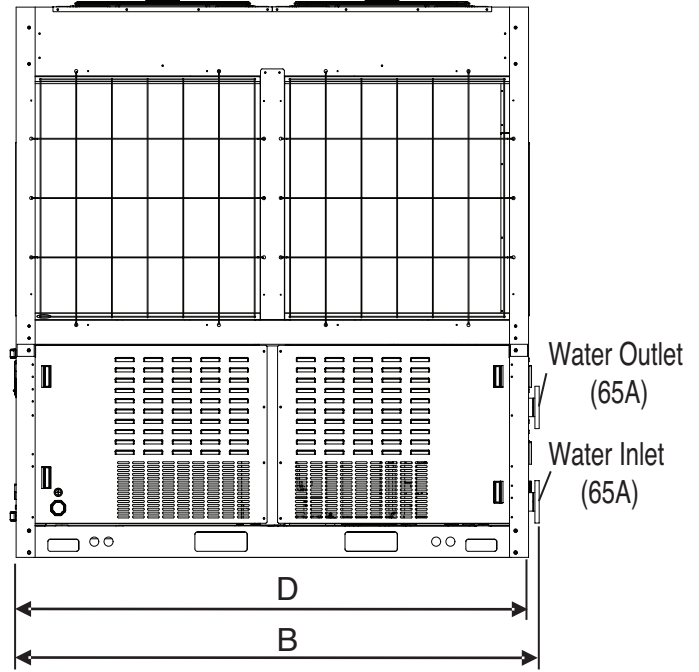

- Side view -

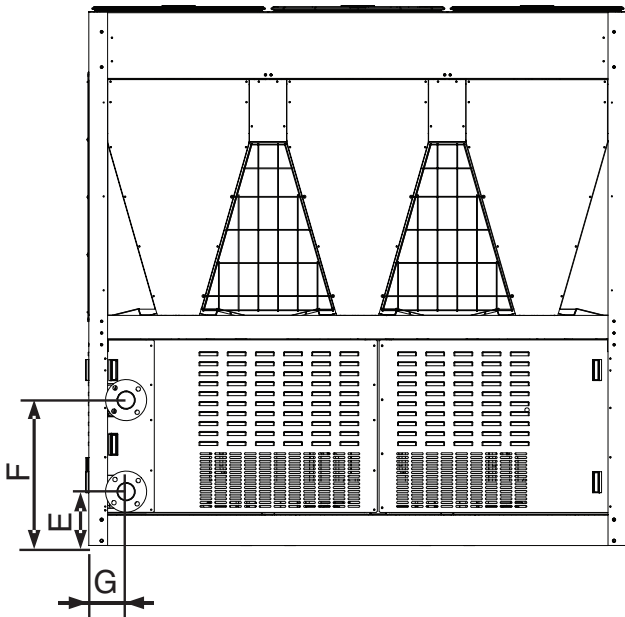

- Rear view -

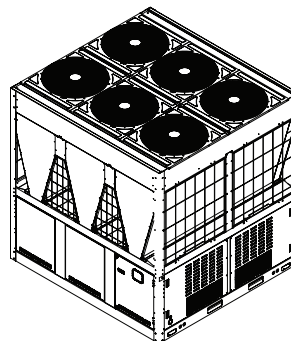

(Unit : mm)

Classification	Dimension
A	2,291
B	2,199
C	2,300
D	2,154
E	230
F	619
G	158.8

8. Base of Installation

■ Details to consider when installing the base

- The base must be able to withstand concentrated load.
- The base must be installed with maximum gradient of 1/300.
- The height of the base must be higher than the surface of the water and drain holes must be installed around.
- Set the height of the base according to the installation environment so that the product is not submerged in water. The default height of the base is 200mm and it must be at least doubled in areas with double the snowfall of 100mm or above.
- Install the drain pipe in the drain hole.
The drainage must be finished so that particles around the drainage do not clog the pipes.
- LG is not responsible for product failure or damage from incorrectly designed or manufactured base.

• Shape of anchor bolt

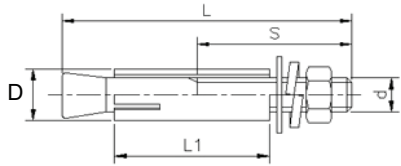

• Specification of anchor bolt

Screw size (d)	L	S	D	L1	Used drill	Depth of drill (min.)	Pullout load (N)
15.88mm(M16)	125	70	22	65	22	65	42 140

• Dimension

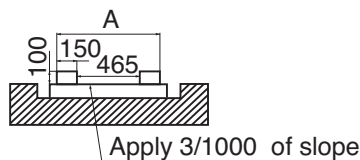
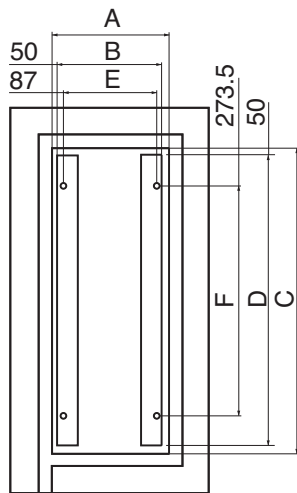

< 1 Unit Drawing of base >

• Shape of anchor bolt (Unit : mm)

	1 Unit	2 Unit	3 Unit
A	865	1,628	2,391
B	765	1,528	2,291
C	2,254	2,254	2,254
D	2,154	2,154	2,154
E	691	1,456	2,217
F	1,707	1,707	1,707

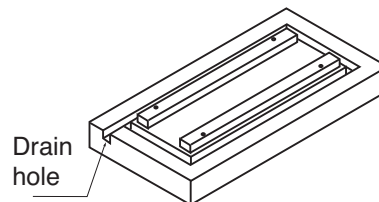

Air-Cooled Scroll Chiller (R410A)

8. Base of Installation

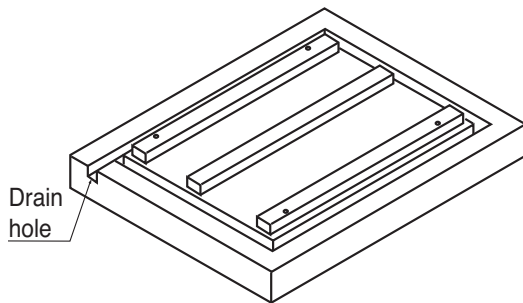
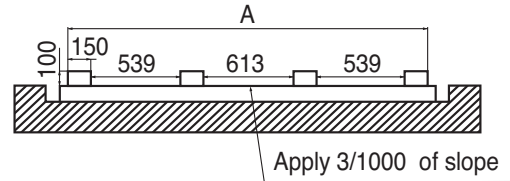
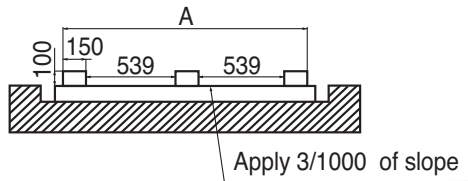
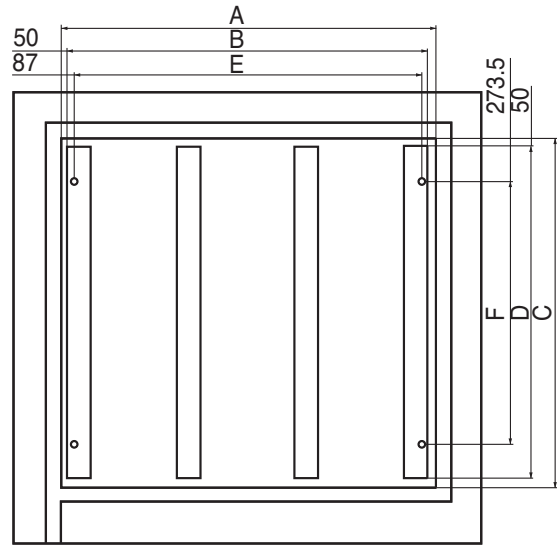
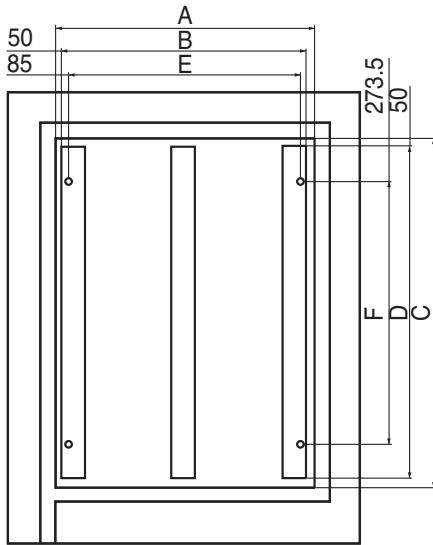

< 2 Unit Drawing of base >

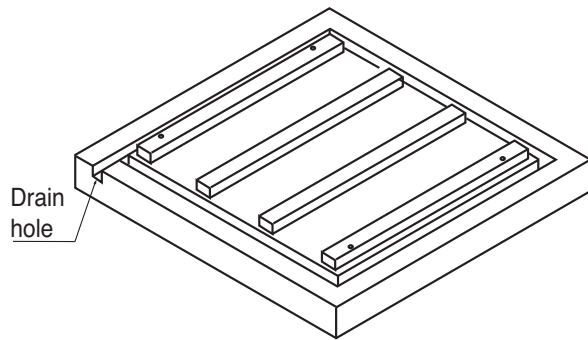

< 3 Unit Drawing of base >

Air-Cooled Scroll Chiller (R410A)

9. Electric Characteristics

Electric specification

ACHH	Unit			Power Supply		COMP		OFM	
	Hz	Volt	Voltage-range	MCA	MFA	MSC	RLA	kW	FLA
020LBAB	50	380 ~ 415	Min.:342, Max.:456	54.0	60	11.8	28.4	1.8	5
023LBAB	50	380 ~ 415	Min.:342, Max.:456	54.0	60	11.8	36.5	1.8	5
033LBAB	50	380 ~ 415	Min.:342, Max.:456	108.0	125	23.6	45.1	3.6	10
040LBAB	50	380 ~ 415	Min.:342, Max.:456	108.0	125	23.6	56.9	3.6	10
045LBAB	50	380 ~ 415	Min.:342, Max.:456	108.0	125	23.6	73.1	3.6	10
050LBAB	50	380 ~ 415	Min.:342, Max.:456	162.0	200	35.4	67.6	5.4	15
060LBAB	50	380 ~ 415	Min.:342, Max.:456	162.0	200	35.4	85.3	5.4	15
067LBAB	50	380 ~ 415	Min.:342, Max.:456	162.0	200	35.4	109.6	5.4	15

Notes:

1. RLA is the current required when operated in the following condition.
Cooling : Outdoor air temp. 27°C DB / 19.0°C WB,
Water inlet / Outlet temp. 12°C / 7°C
Heating : Outdoor air temp. 7°C DB / 6.0°C WB,
Water inlet / Outlet temp. 40.0°C / 45.0°C
2. Voltage range
The chiller must be operated at the voltage within the upper and lower limit supplied from the power terminal to operate normally.
3. Maximum voltage variance permitted between phases is 2%.
4. MCA is the criteria of selecting the wiring standard.
5. MFA is used when selecting circuit breaker and grounding error circuit breaker (Electricity leakage circuit breaker).

MCA: Minimum Circuit Ampere, A
MFA: Maximum Fuse Ampere, A
RLA: Rated Load Ampere, A
MSC: Maximum Start Current, A

Air-Cooled Scroll Chiller (R410A)

10. Wiring Diagrams

1 Unit, 2 Unit(Main), 3 Unit(Main)

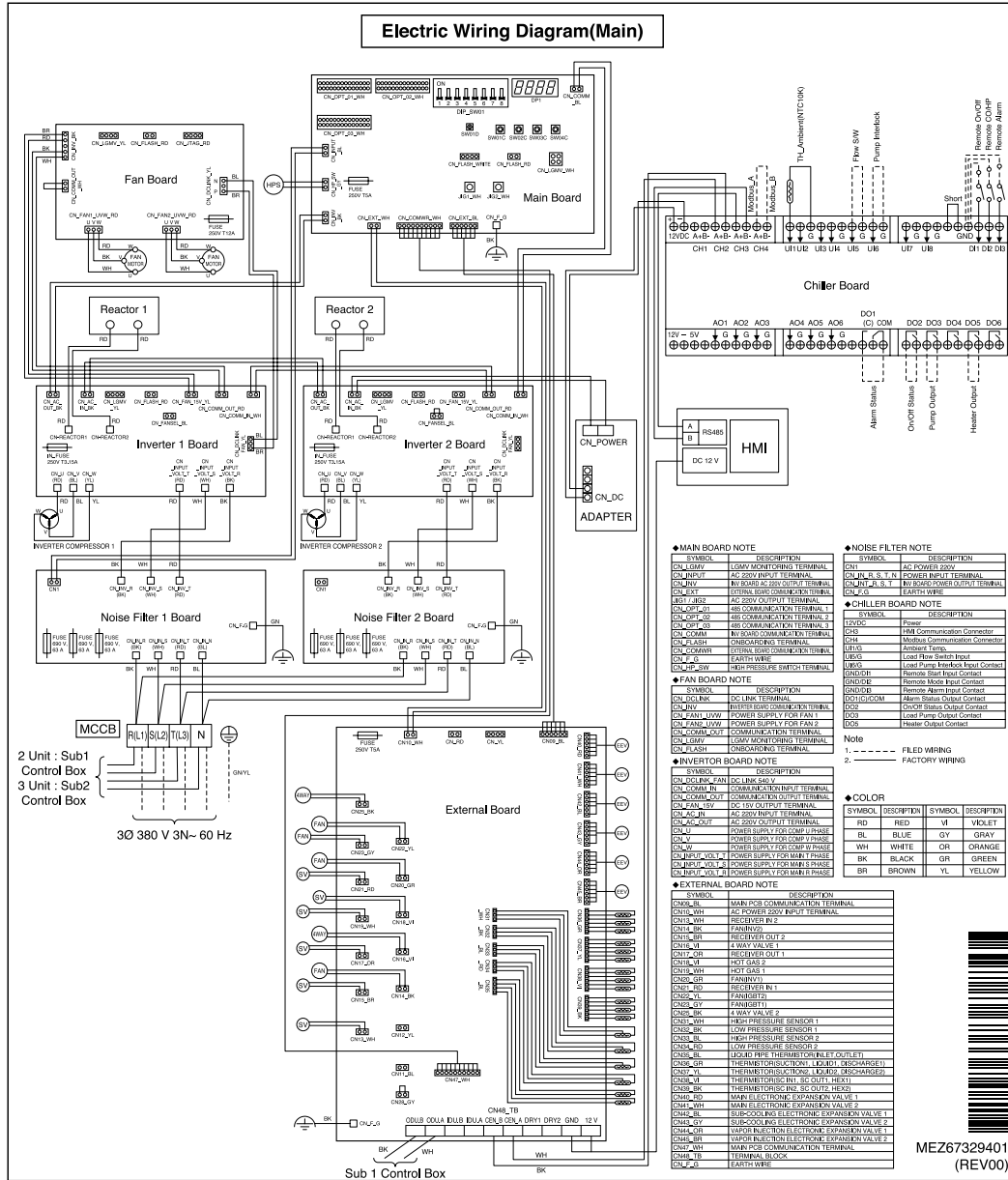

Air-Cooled Scroll Chiller (R410A)

10. Wiring Diagrams

3 Unit(Sub1)

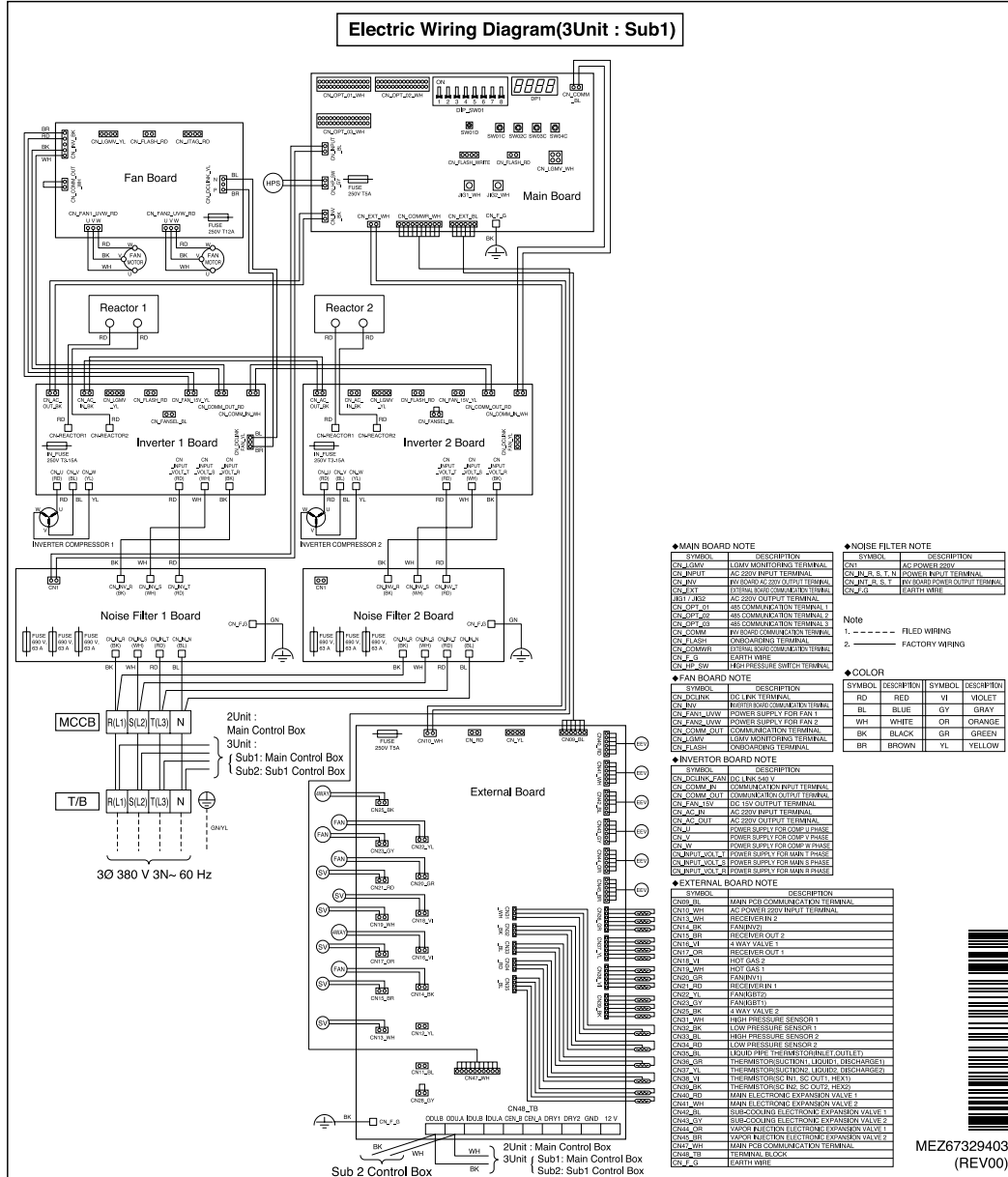

11. Installation of Chiller

Selecting installation location

■ Precaution when selecting the installation location

Select the location that fits the following conditions to install the product.

- Location without direct heat from other heat source
- Location where noise of the chiller does not have negative impact to the neighbors
- Check the installation direction of the unit for the seasonal wind during the winter.
Install the product so that the seasonal wind does not affect only one side of the product.
- Location not exposed to strong winds
- Location that can support the weight of the chiller
- Location with space for air flow and service
- Install the boundary sign, danger sign or barricade, if necessary.
- It is recommended to install a fence around chiller so that people or animals will not be able to access the area.
- When installing the product in areas with high humidity during the winter (Coast, seaside, lakeside), install the product where it is well ventilated and has plenty of exposure to sunlight. (Ex: Roof top with sunlight)
- If the product does not run during the winter, establish a plan to use the anti-freeze for the water supply.
- To prevent the condensed water from flowing, insulate the connected evaporator and pipe.
- To smoothly drain the condensed water, establish an inclined structure.
- Avoid installing the product at locations with the following conditions.
 - Location with corrosive gas such as acid or alkali gas.
(Coolant can leak from the corroded pipes.)
 - Location with electromagnetic wave.
(It can cause the product to malfunction from defective parts.)
 - Location where flammable gas is generated or flows to prevent fire.
 - Location with high level of carbon fiber or dust
 - Special location exposed to oil, steam or emulsified gas

11. Installation of Chiller

■ Precaution for seasonal wind and winter season

In areas with heavy snow or in extremely cold areas, sufficient planning is required for the product to run smoothly.

Even in other areas, planning is required for seasonal wind during the winter season.

- Snow can go into the air discharge outlet of the condenser to freeze inside the chiller. Therefore install a large cover over the chiller for areas with heavy snowfall to prevent the snow from accumulating on the top.
- The chiller can freeze inside when the air inlet is clogged with snow. Therefore install the chiller on the base with at least twice the height of the average snow accumulation.
(Default height of base: 300mm)
- If there is more than 100mm of snow on top of the chiller, always operate the unit after cleaning the snow.
- Do not install the product where there could be negative impact from snow in areas with heavy snowfall. Decide the installation direction of the chiller so that the side of the air heat exchanger does not face the direction of the snow.
(Make the side of the air heat exchanger parallel to the direction of the snowfall.) Install a blocker with the height of the snow accumulation to avoid the snow around the chiller from being sucked into the coil side.
(Prepare on site)
- If the wind comes in one direction of the unit where the seasonal wind is strong, there is a high chance that it can lead to issue with product capacity or imbalance of load. Therefore install the product so that it has consistent effect on the product cycle. If that is not possible, consider using a wind blocker or other devices. In areas with strong seasonal wind during the winter, apply the wind blocker hood, especially near the coastal area, without blocking the suction inlet of the chiller considering the direction of the wind. If the chiller is directly exposed to the seasonal wind during the winter, separately install a wind baffle. (Prepare on site)

11. Installation of Chiller

Installation Guide at the seaside

CAUTION

- When installing the chiller near the coast, make sure that it is not directly exposed to the coastal wind.
- When installing the chiller directly exposed to the coastal wind, separate anti-corrosive treatment must be done on the condenser of the chiller.

* Selecting location of chiller

Install the chiller where the building can block the coastal wind.

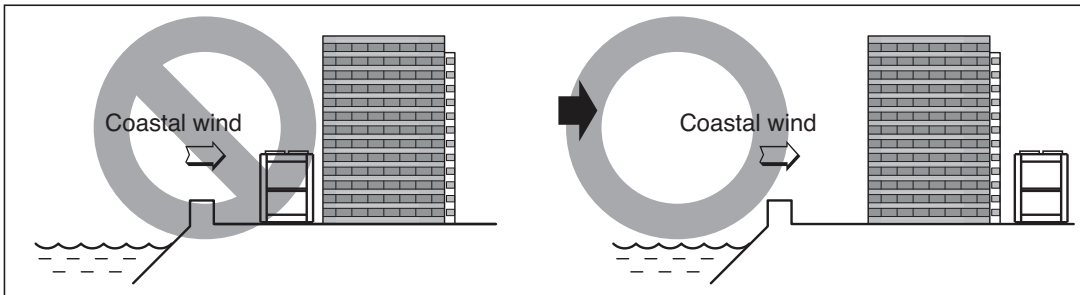

If the product has to be installed inevitably facing the coast, install a wall around the outdoor unit.

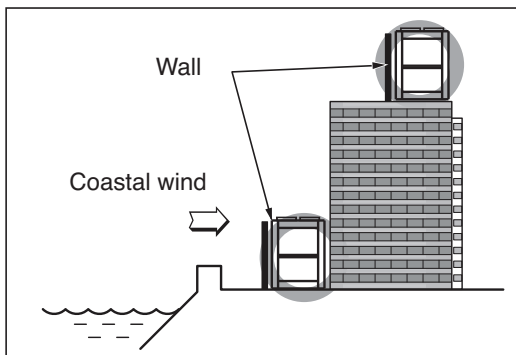

The wall must be made of sufficiently strong material such as concrete to block the coastal wind and must be 1.5 times larger than the size of the product to protect the product 1000mm apart. There must be 1000mm of clearance between the wall and the chiller for smooth circulation of air.

Install the product where the drainage is smooth.

Air-Cooled Scroll Chiller (R410A)

11. Installation of Chiller

When installing the product, secure minimum space as shown below considering the service, suction and discharge of air flow.

■ Consider the ventilation condition.

The air cooled chiller must be installed on open space or must have appropriate ventilation.

When installed along the wall, there must be sufficient space for ventilation.

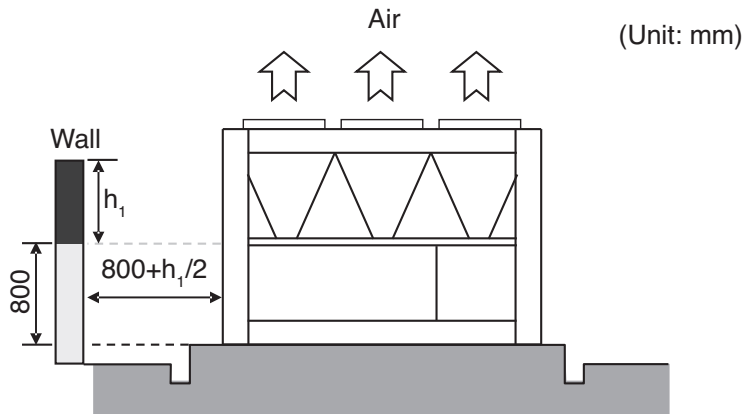

Reference

If the side of the chiller is near the wall and the height of the wall is less than 800mm, the distance between the wall and the chiller must be at least 800mm. If the side of the chiller is near the wall and the wall is 800mm or higher, space of half of h_1 must additionally be secured on top of the 800mm for the distance between the wall and the chiller.

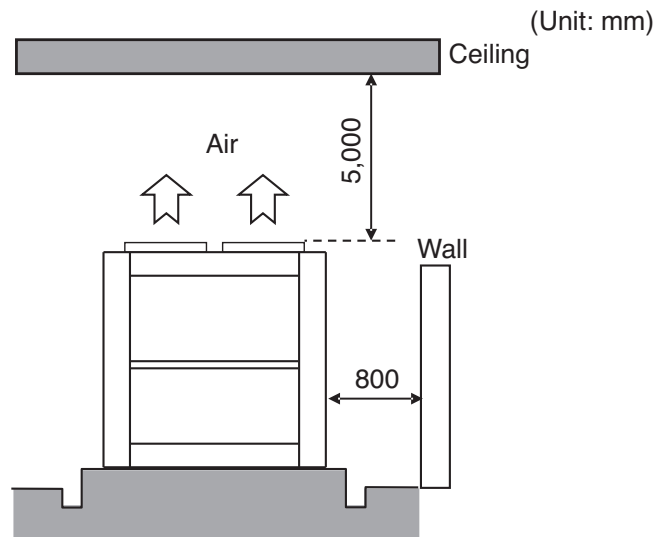

Reference

If there is a ceiling on the top part of the chiller, the distance from the chiller to the ceiling must be 5000mm or above.

If the front or rear side of the chiller is close to the wall, the distance from the wall to the chiller must be 800mm or above.

11. Installation of Chiller

Consider the service space.

- There must be sufficient space for maintenance and repair work around the chiller.

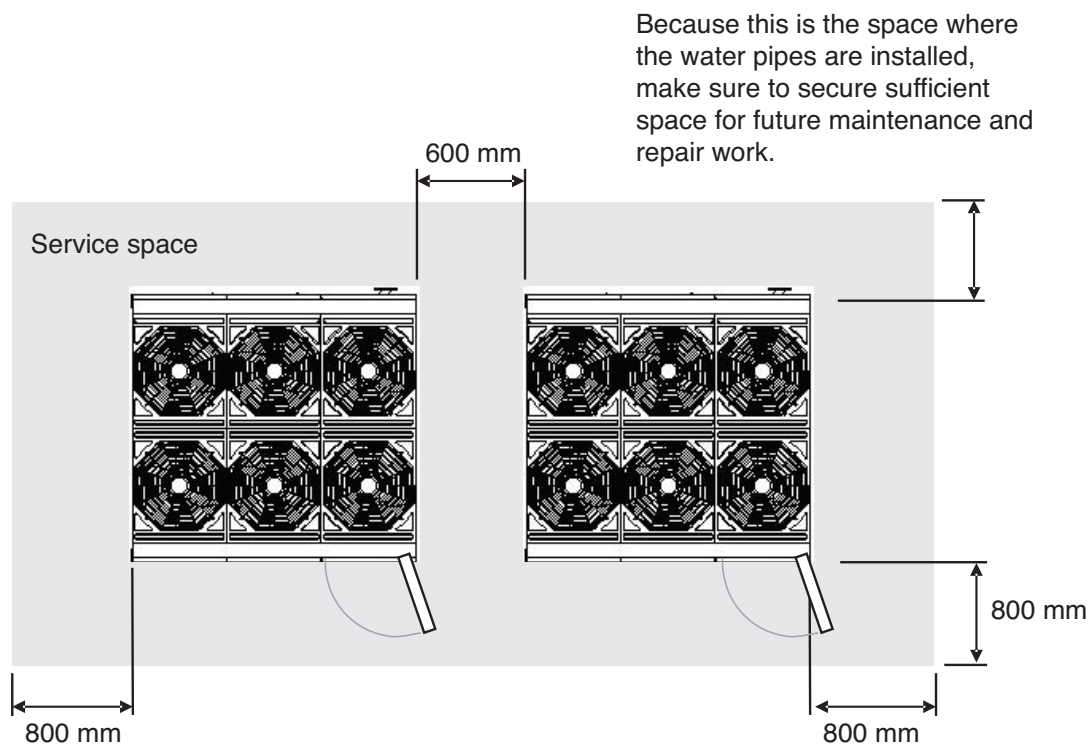
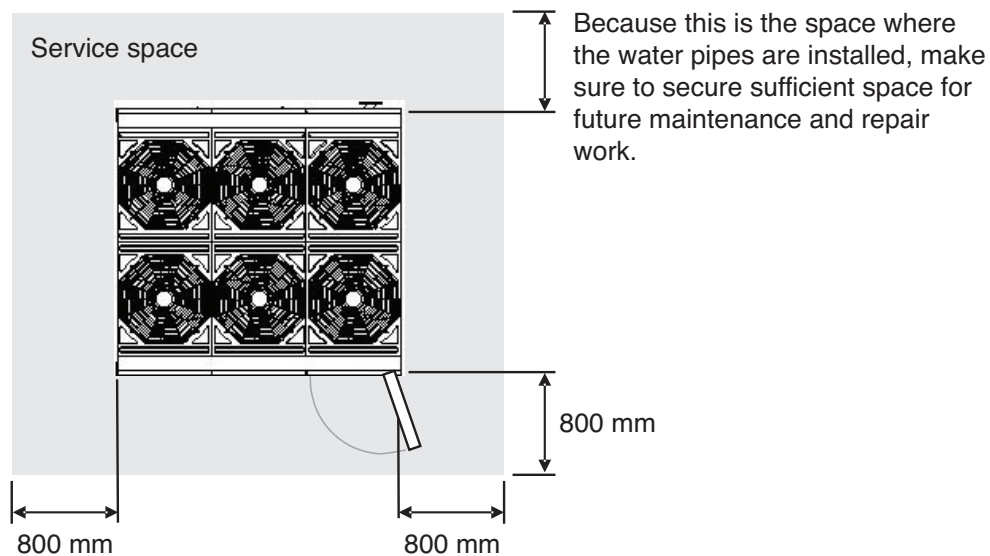

11. Installation of Chiller

Water management

The water quality of the cold (hot) water is described as follows. The water quality must not fall below the following standard. If so, it can be judged to have risk within relatively short period of time.

Item		Water	
		Circulation type cold water	Cold water
Reference	PH(25°C)	6.5 - 8.0	6.5 - 8.0
	Conduction rate (25°C $\mu\text{s/cm}$)	500 or below	200 or below
	Alkali level (PPM)	100 or below	50 or below
	Hardness (PPM)	100 or below	50 or below
	Chlorine ion (PPM)	100 or below	50 or below
	Lactic acid ion (PPM)	100 or below	50 or below
	Iron (PPM)	0.1 or below	0.3 or below
	Sulfur ion (PPM)	Not detected	Not detected
	Ammonium ion (PPM)	0.5 or below	0.2 or below
	Silica (PPM)	50 or below	30 or below

Water pipe connection

- Connect the pipe so that the entrance of the cold (hot) water pipe is correct.
- Permitted water pressure resistance of cold water pipe system is 1MPa
- To prevent any external heat loss or dew drops forming during the cooling operation on the water pipe system, apply thermal insulation treatment.
- Install the air vent at the output end of the water pipe. (Air vent)
- If the thermometer is installed on the inlet/outlet of the cold/hot water pipe, the operating condition of the chiller can be checked.
- Always install the strainer (50 Mesh or above) that can be cleaned on the water pipe inlet side to filter any alien particles from entering the heat exchanger.
- Always install the strainer on the leveled pipe. (If sand, trash or rust gets mixed to the cold water system, it can cause product failure due to corrosion of metallic parts.)
- Install the on/off valve on the cold water inlet/outlet and bypass pipe on the pipe direction of the device side.
 - For the pipe system, it is recommended to install the bypass and clean the pipe before installing the product and during the annual pipe cleaning.
 - On/Off valve blocks the old water to the chiller that is not operating to reduce the power of the pump. Therefore select whether to install to fit the need of the site.
- Install the pressure gauge and thermometer on the inlet and outlet of the water pipe.
- Always install the flexible joint to reduce the vibration of the pipe and product.
 - Vibration of water pipe system is absorbed to prevent water leakage.
- For the cold water system part, make sure to use the component that complies with designed water pressure or above.
- Before supplying cold water to the chiller, clean inside the pipe system to remove any negative impact of particles to the product.

11. Installation of Chiller



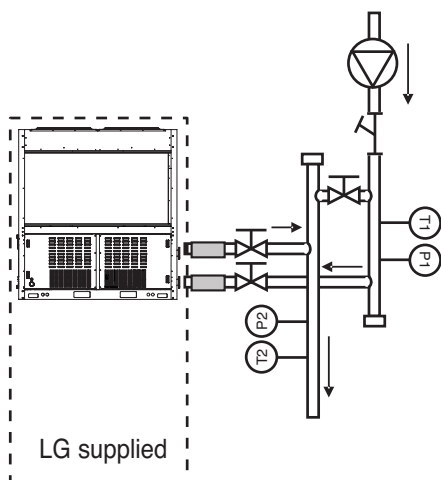

Installation mode A (Recommended method)

* Independent product installation

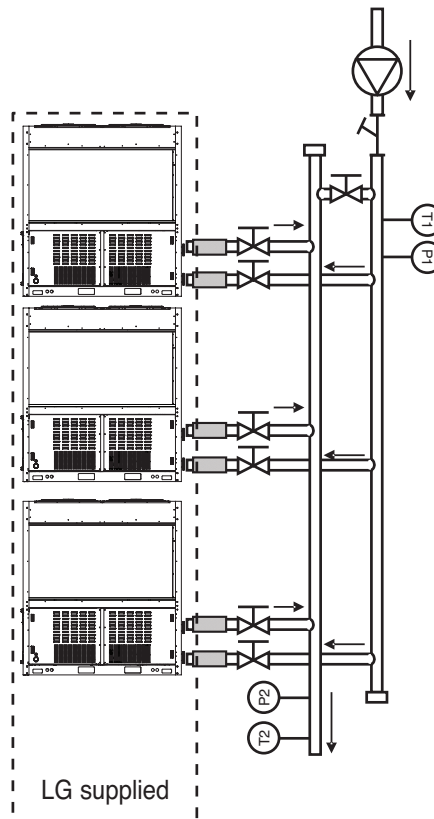

* Independent product installation



Symbol	Description	Symbol	Description
	Valve	T1	Temperature sensor (1: Inlet 2: Outlet)
	Strainer	P1	Pressure gauge (1: Inlet, 2 Outlet)
	Flexible joint		Cold water pump

11. Installation of Chiller



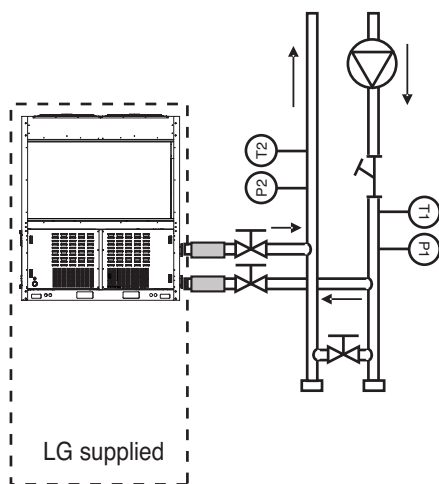

Installation mode B

* Independent product installation

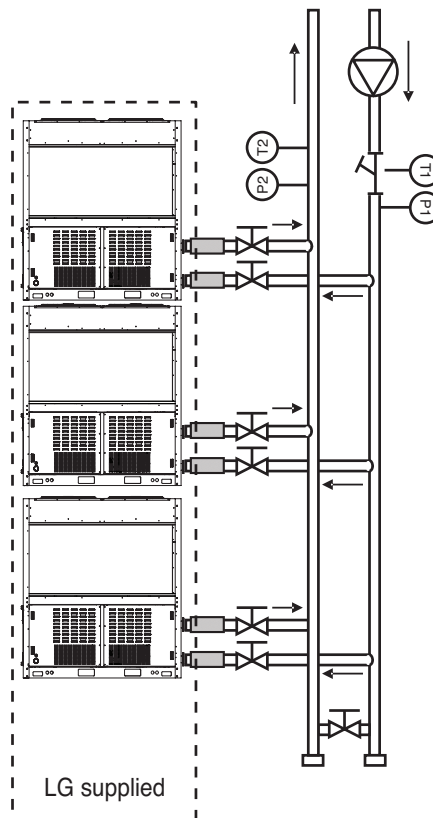

* Independent product installation



Symbol	Description	Symbol	Description
	Valve	T1	Temperature sensor (1: Inlet 2: Outlet)
	Strainer	P1	Pressure gauge (1: Inlet, 2 Outlet)
	Flexible joint		Cold water pump

11. Installation of Chiller

CAUTION

- If the winter outdoor temperature is 0°C or below, take following measures to prevent the pipe from freezing as shown below.
 - If the outdoor temperature is low, the circulation water can freeze to damage the heat exchanger of the product when the product is stopped.
If there is possibility of damage from low outdoor temperature, operate the pump to prevent the water from freezing.
 - If the product does not operate for a long period of time during the winter season, remove all the circulation water to prevent the damage of heat exchanger and pipe from freezing.
 - Add anti-freeze additive to prevent the circulation water from freezing during the winter season.
- Maintain the cold water flux within the designed flux to ensure appropriate chiller performance and reduce the tube damage from rusting, scaling and corrosion. LG is not responsible for any damage of chiller from poor water quality management or inappropriate processing water.

Water pipe installation

- Appropriate pressure of pipe connection is flange connection of 1 MPa or below.
- Size of the water pipe must be the same as that of the product or larger.
- If there is risk of dew drops forming, always install the thermal insulation material on the outlet pipe of the cold water.
- To avoid connected water pipe from creeping from the load, use appropriate hook for support.
- To prevent the pipe connected part from freezing during the winter season, always install the drain valve at the most bottom of the pipe system.
- Cold water inlet pipe is located at the bottom and the outlet pipe is installed on the top.
- When connecting several chillers, refer to the following for common pipe size.

Full product capacity	20 RT	40 RT	60 RT	80 RT	100 RT	120 RT	140 RT	160 RT	180 RT
Common pipe size	65 A	80 A	100 A	100 A	125 A	125 A	125 A	150 A	150 A
Product	20 RT	●							
	40 RT		●		●●	●	●●	●	
	60 RT			●		●	●●	●	●●●

Full product capacity	200 RT	220 RT	240 RT	260 RT	280 RT	300 RT
Common pipe size	150 A	200 A	200 A	200 A	200 A	200 A
Product	20 RT					
	40 RT	●●	●		●●	●
	60 RT	●●	●●●	●●●●	●●●	●●●●●

Water pump control

- If the cold water pump is not operating for a long period of time or if the anti-freeze liquid is not used as the cold water, the anti-freeze pump control must be installed to prevent the pipe from freezing.
- The vibration of the pump can transfer to the pipe to cause noise indoors. As the plan to prevent the noise from spreading in the pump, install flexible joints at the inlet/outlet and use the anti-vibration amount for the pump support.

11. Installation of Chiller

Unit Combination

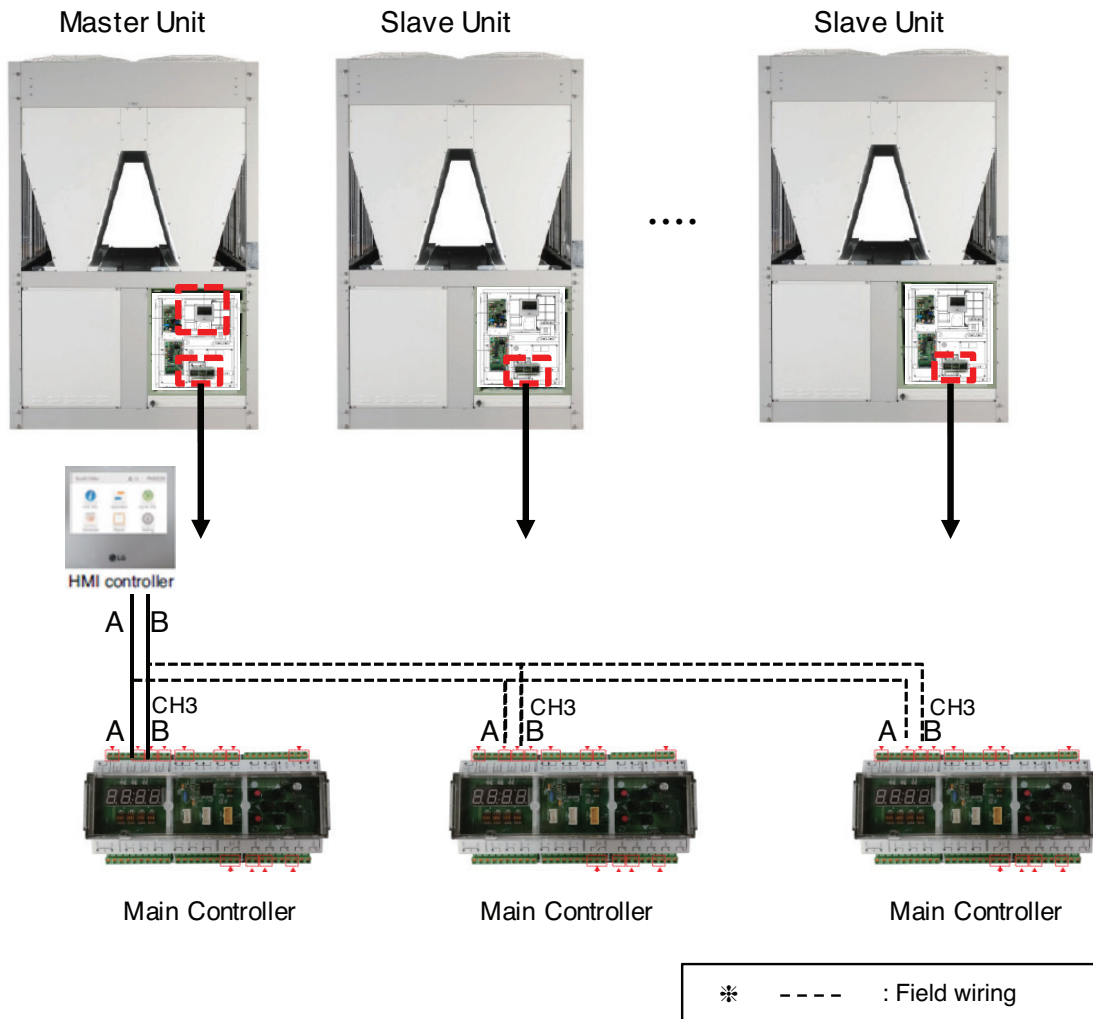

- 1) Communication line is divided A into B like a picture and is jump connected to Main Unit and Main Controller CH3 of Slave unit.
- 2) Communication line jump connected is divided A into B to HMI of Master Unit and in connected.
- 3) Use 2-line shield as a communication line
- 4) Separately install the communication and power cable of the chiller so that communication cable is not affected by the electric noise generated from power cable (Do not pass through the same electric pipe)
- 5) Unit combination is able to connect up to 5 units.

! WARNING

If number and address of product to want to interlock is not set from HMI, Error will occur. (please refer to control>freezer interlocking control about HMI address setting)

If Main Controller address doesn't match HMI address, Error will occur. (please refer to control>freezer address setting about Controller address setting)

Air-Cooled Scroll Chiller (R410A)

11. Installation of Chiller

■ 380 - 415 V

Table 1: Standard Combination

Below standard combination will provide the maximum efficiency among all possible combination, which does not require the constant flow valve.

Set Model	Unit Combination				
	Unit 1	Unit 2	Unit 3	Unit 4	Unit 5
ACHH066LAAB	ACHH033LBAB	ACHH033LBAB			
ACHH080LAAB	ACHH040LBAB	ACHH040LBAB			
ACHH083LAAB	ACHH033LBAB	ACHH050LBAB			
ACHH090LAAB	ACHH045LBAB	ACHH045LBAB			
ACHH100LAAB	ACHH050LBAB	ACHH050LBAB			
ACHH112LAAB	ACHH045LBAB	ACHH067LBAB			
ACHH116LAAB	ACHH033LBAB	ACHH033LBAB	ACHH050LBAB		
ACHH120LAAB	ACHH060LBAB	ACHH060LBAB			
ACHH133LAAB	ACHH033LBAB	ACHH050LBAB	ACHH050LBAB		
ACHH135LAAB	ACHH067LBAB	ACHH067LBAB			
ACHH140LAAB	ACHH040LBAB	ACHH040LBAB	ACHH060LBAB		
ACHH150LAAB	ACHH050LBAB	ACHH050LBAB	ACHH050LBAB		
ACHH157LAAB	ACHH045LBAB	ACHH045LBAB	ACHH067LBAB		
ACHH160LAAB	ACHH040LBAB	ACHH060LBAB	ACHH060LBAB		
ACHH166LAAB	ACHH033LBAB	ACHH033LBAB	ACHH050LBAB	ACHH050LBAB	
ACHH180LAAB	ACHH060LBAB	ACHH060LBAB	ACHH060LBAB		
ACHH183LAAB	ACHH033LBAB	ACHH050LBAB	ACHH050LBAB	ACHH050LBAB	
ACHH200LAAB	ACHH050LBAB	ACHH050LBAB	ACHH050LBAB	ACHH050LBAB	
ACHH203LAAB	ACHH067LBAB	ACHH067LBAB	ACHH067LBAB		
ACHH215LAAB	ACHH033LBAB	ACHH033LBAB	ACHH050LBAB	ACHH050LBAB	ACHH050LBAB
ACHH220LAAB	ACHH040LBAB	ACHH060LBAB	ACHH060LBAB	ACHH060LBAB	
ACHH225LAAB	ACHH045LBAB	ACHH045LBAB	ACHH067LBAB	ACHH067LBAB	
ACHH233LAAB	ACHH033LBAB	ACHH050LBAB	ACHH050LBAB	ACHH050LBAB	ACHH050LBAB
ACHH240LAAB	ACHH060LBAB	ACHH060LBAB	ACHH060LBAB	ACHH060LBAB	
ACHH247LAAB	ACHH045LBAB	ACHH067LBAB	ACHH067LBAB	ACHH067LBAB	
ACHH250LAAB	ACHH050LBAB	ACHH050LBAB	ACHH050LBAB	ACHH050LBAB	ACHH050LBAB
ACHH260LAAB	ACHH020LBAB	ACHH060LBAB	ACHH060LBAB	ACHH060LBAB	ACHH060LBAB
ACHH270LAAB	ACHH067LBAB	ACHH067LBAB	ACHH067LBAB	ACHH067LBAB	
ACHH280LAAB	ACHH040LBAB	ACHH060LBAB	ACHH060LBAB	ACHH060LBAB	ACHH060LBAB
ACHH290LAAB	ACHH045LBAB	ACHH045LBAB	ACHH067LBAB	ACHH067LBAB	ACHH067LBAB
ACHH300LAAB	ACHH060LBAB	ACHH060LBAB	ACHH060LBAB	ACHH060LBAB	ACHH060LBAB
ACHH315LAAB	ACHH045LBAB	ACHH067LBAB	ACHH067LBAB	ACHH067LBAB	ACHH067LBAB
ACHH335LAAB	ACHH067LBAB	ACHH067LBAB	ACHH067LBAB	ACHH067LBAB	ACHH067LBAB

NOTE

- For more combination, please refer to Table 2.

Air-Cooled Scroll Chiller (R410A)

11. Installation of Chiller

Table 2: All possible combination

The combination within the same group up to 5 units do not require constant flow valve. The combination with other groups will require constant flow valve to be installed.

Group A	Group B	Group C
20 RT	33 RT	23 RT
40 RT	50 RT	45 RT
60 RT	-	67 RT

Case 1: Combined WITH constant flow valve

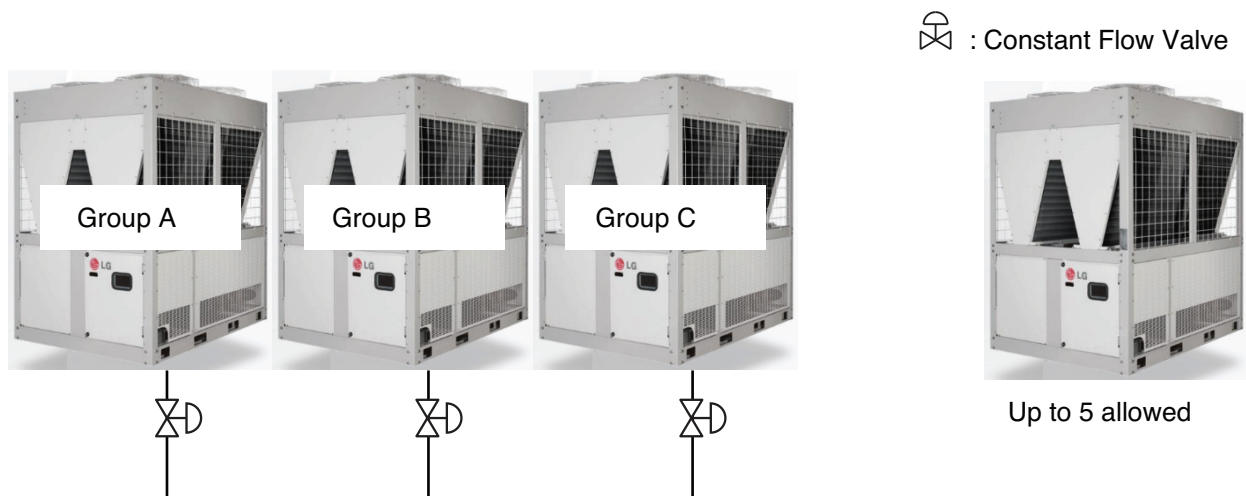

Case 2: Combined WITHOUT constant flow valve

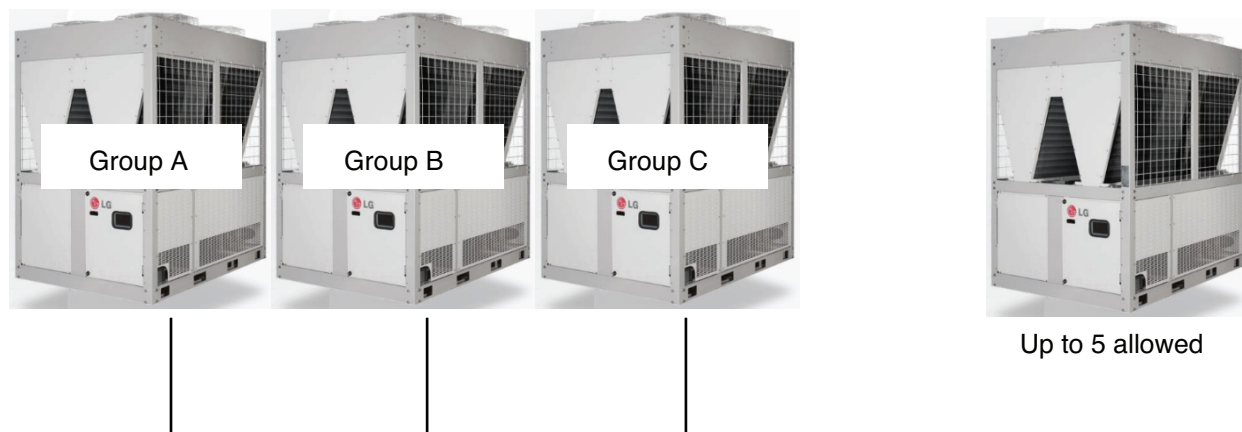

Air-Cooled Scroll Chiller (R410A)

12. Specification of Production

Manufacturing specification

- 1) Use the parts and material of KS standard products or equivalent products for those not specified in this specification, and all parts should be designed with structure that is easy for replacement, repair, and inspection.
- 2) If there is a problem in the chiller, or if there is an abnormal status of chilled water temperature and flow amount, etc., immediately stop the chiller operation and you have to be equipped with marking equipment or function that can easily identify these.
- 3) There should be a protection circuit to prevent freezer damage by blackout or frequent voltage variation from Electronic Power company.
- 4) Chiller should be able to operate silently without abnormal noise or abnormal vibration.
- 5) Chiller should be composed of the central controller and the circuit possible for wired/wireless Start/Stop operation.
- 6) Easy combination should be possible with compact product design and module type design, and basic module insertion and assembly installation should be possible regardless of the volume.
- 7) It should be the structure possible for substitute operation even if compressor or some cycle parts fail and cooling operation should be possible during parts replacement, repair, or inspection.
- 8) The main power cable equivalent or above the specification presented in the product specification of each corresponding model should be used for the chiller, each communication line and power cable should use cable pipe for protection, and the cable pipe with the material that can block external noise according to the installation environment should be used.

Air cooled type scroll chiller product specification

1. Case

- 1) It should have the structure that is easy for disassembly and assembly for easy maintenance/repair.
- 2) It should have a beautiful exterior and it should be insulated to prevent dew condensation.
- 3) It should have the structure preventing vibration and abnormal noise.
- 4) It should have the structure that can be grounded.

2. Compressor

- 1) R410A refrigerant should be used, case shape should be sealed type, format should be the combination of two inverter scroll compressors, it should be flexible to respond to load, and it should be a high efficiency system that can optimize energy efficiency through inverter control.
- 2) Vibration prevention rubber should be used to prevent transfer of noise and vibration during operation.
- 3) The frequency variable boundary of inverter scroll compressor should be minimum 30Hz and maximum 130Hz.

3. Condenser

- 1) Condenser heat pipe should use purity 99.9 % or above Phosphorus Deoxidized Copper without joint, and it should have the structure with Al fin attached to increase the heating area. (Cross fin & Tube type)
- 2) Use wide louver fin for Al fin, and pipe extension should be carried out for efficient heat transfer.
- 3) Condenser air cooled type heat exchanger arrangement should be 3 rows 48 levels 14FPI.
- 4) The pressure endurance test for high pressure part refrigerant side should be carried out at 4.18 MPa or above (designed pressure 3.8 MPa), and there should be problems such as leakage or deformation.

Air-Cooled Scroll Chiller (R410A)

12. Specification of Production

- 5) The condensing coil that passed pressure endurance test should be vacuumed to completely remove moisture inside.
- 6) Use propeller type Fan, and it should be able to give sufficient wind amount required for condensing. Also, it should have sufficient strength for the number of rotations, and it should be operated silently through balance test.
- 7) Motor should be BLDC type that can increase efficiency.
- 8) Fan and Motor should be connected directly.

4. Electronic Expansion Valve

- 1) It is the part that insulates and expands high pressure fluid refrigerant at condenser exit in low temperature • low pressure state, and during cooling operation, line shape electronic expansion valve should be activated to adjust adequate refrigerant amount according to the evaporator load.
- 2) Based on data of various sensors installed in the freezer, microcomputer unit should be able to analyze operation status of the system and compressor to control the most adequate refrigerant amount linearly.
- 3) By applying electric pulse signal to stepping motor, it should be able to play the role of adjusting the refrigerant flow amount.

5. Evaporator

- 1) Evaporator should be blazing plate type heat exchanger type, and the material should be stainless steel.
- 2) There should be no water leakage, and the durability should be guaranteed.
- 3) It should have the structure that can connect to chilled water pipe.
- 4) Heat exchanger should be sensible heat exchange structure that the refrigerant and coolant are not mixed.
- 5) It should be a structure that each of coolant and refrigerant are flown into countercurrent structure heat exchanger and after heat is exchanged with each other through the thin valve inside heat exchanger, discharged outside heat exchanger.
- 6) In the destruction test, it should endure 18 MPa pressure.

6. Control equipment

- 1) It is the controller to operate overall system in optimal condition with the microcomputer unit installed in the freezer, and based on the 4 measurement values including intake refrigerant gas pressure, discharged refrigerant gas pressure, discharged refrigerant gas temperature, and heat exchanger refrigerant temperature, it should be able to control electronic expansion valve, compressor(inverter), etc.
- 2) There should be a function that can check all sensors connected to the freezer and various operation statuses.
- 3) It should be equipped with self protection equipment and system protection function.
- 4) Module type control interface should be applied so that simple product control is possible in series installation, and relocation and re-installation of HMI controller should be possible without separate control equipment.

7. Ref. Piping

- 1) Refrigerant pipe should be purity 99.9% or above Phosphorus Deoxidized Copper without joint, and it should be piped for fluent refrigerant flow between each component.
- 2) Install strainer in the pipe to filter foreign objects.
- 3) The pipe from expansion valve to evaporator should be insulated to prevent moisture condensation on the surface of the pipe and to prevent flash gas generation of refrigerant fluid at the same time.
- 4) Liquid injection pipe that activates electronic valve to flow fluid refrigerant to the suction pipe when discharged gas temperature is above the rated temperature should be installed to protect compressor and freezer.
- 5) After completing the piping, carry out the pressure endurance test on refrigerant side at 4.18 MPa or above (designed pressure 3.8 MPa), and there should be no leakage or deformation.
- 6) After carrying out air-tight test, completely vacuum inside so that there is absolutely no moisture.

Air-Cooled Scroll Chiller (R410A)

12. Specification of Production

8. Safety devices

- 1) Refrigerant pressure (Normal refrigerant pressure)
 - A. High pressure switch
 - B. High voltage protection (Sensor)
- 2) Temperature
 - A. compressor discharge temperature overheating detection (Sensor)
 - B. IPM temperature detection (Sensor)
 - C. Freeze and burst protection (Sensor)
 - D. Power Module application (Sensor)
- 3) Chilled water flow
 - A. Chilled water flow switch (Field wiring)
- 4) Voltage and current (control logic)
 - A. Revere phase detection and protection (Voltage monitoring system)
 - B. Compressor over-current protection
 - C. Fan motor over-current protection
- 5) Fuse

Accessory list

1	PACP5A000 (ACP 5 Central Control)
---	-----------------------------------

Air-Cooled Scroll Chiller (R410A)

13. Appendix – Piping Diagram

■ 1Unit (ACHH020LBAB, ACHH023LBAB)

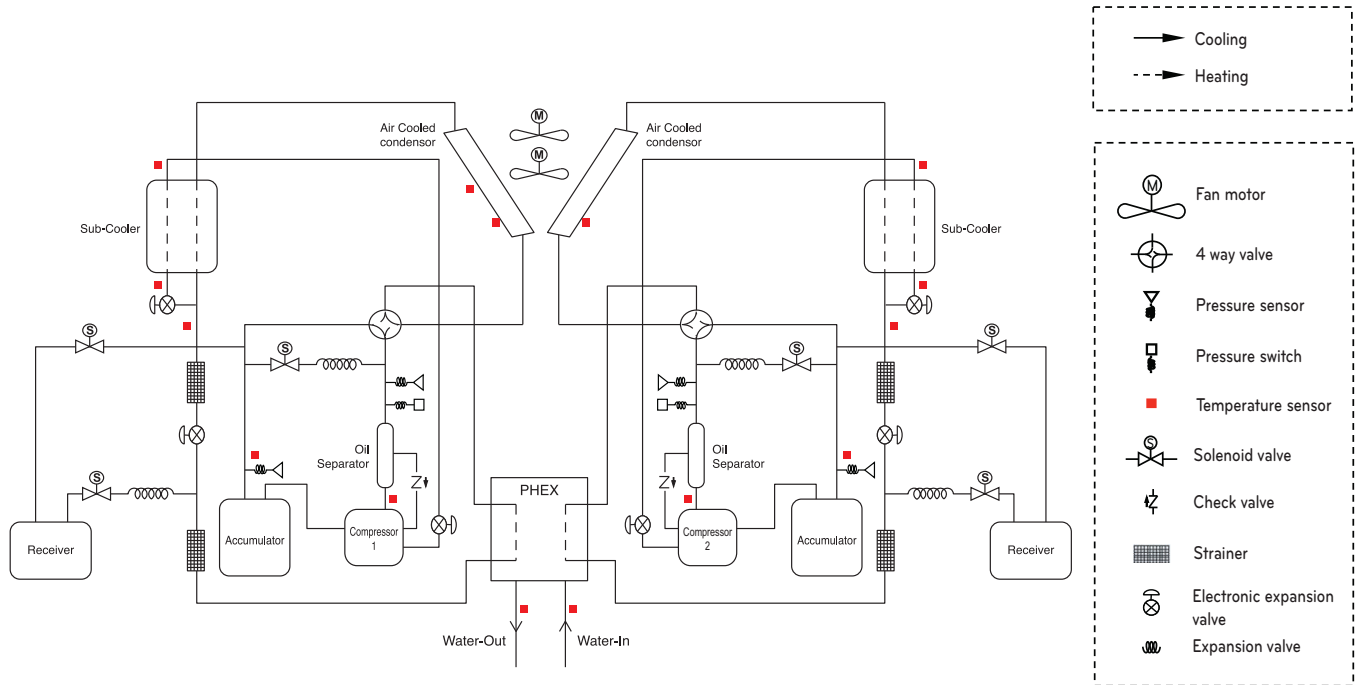

Air-Cooled Scroll Chiller (R410A)

13. Appendix – Piping Diagram

■ 2Unit(ACHH033LBAB, ACHH040LBAB, ACHH045LBAB)

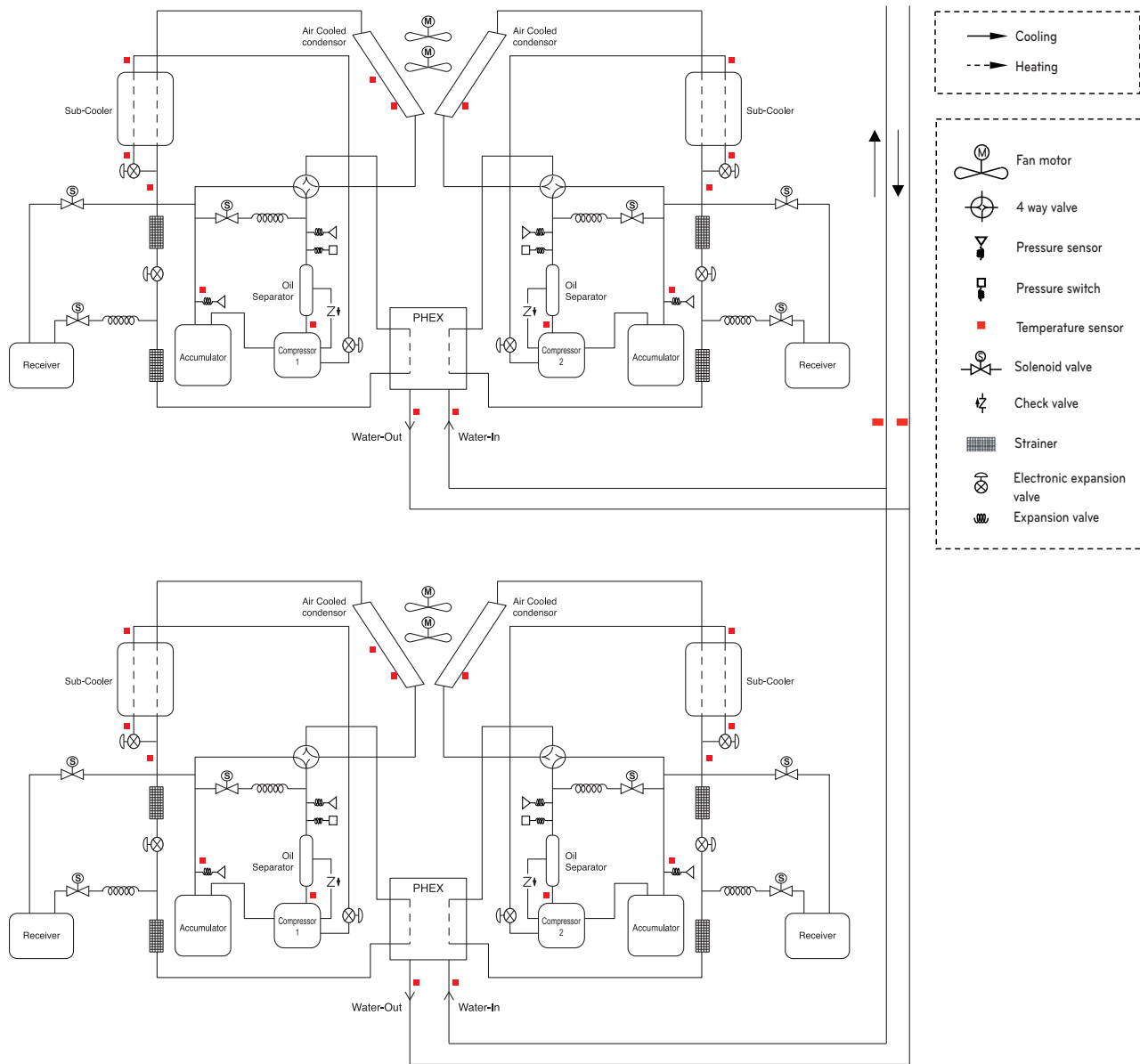

Air-Cooled Scroll Chiller (R410A)

13. Appendix – Piping Diagram

■ 3Unit(ACHH050LBAB, ACHH060LBAB, ACHH067LBAB)

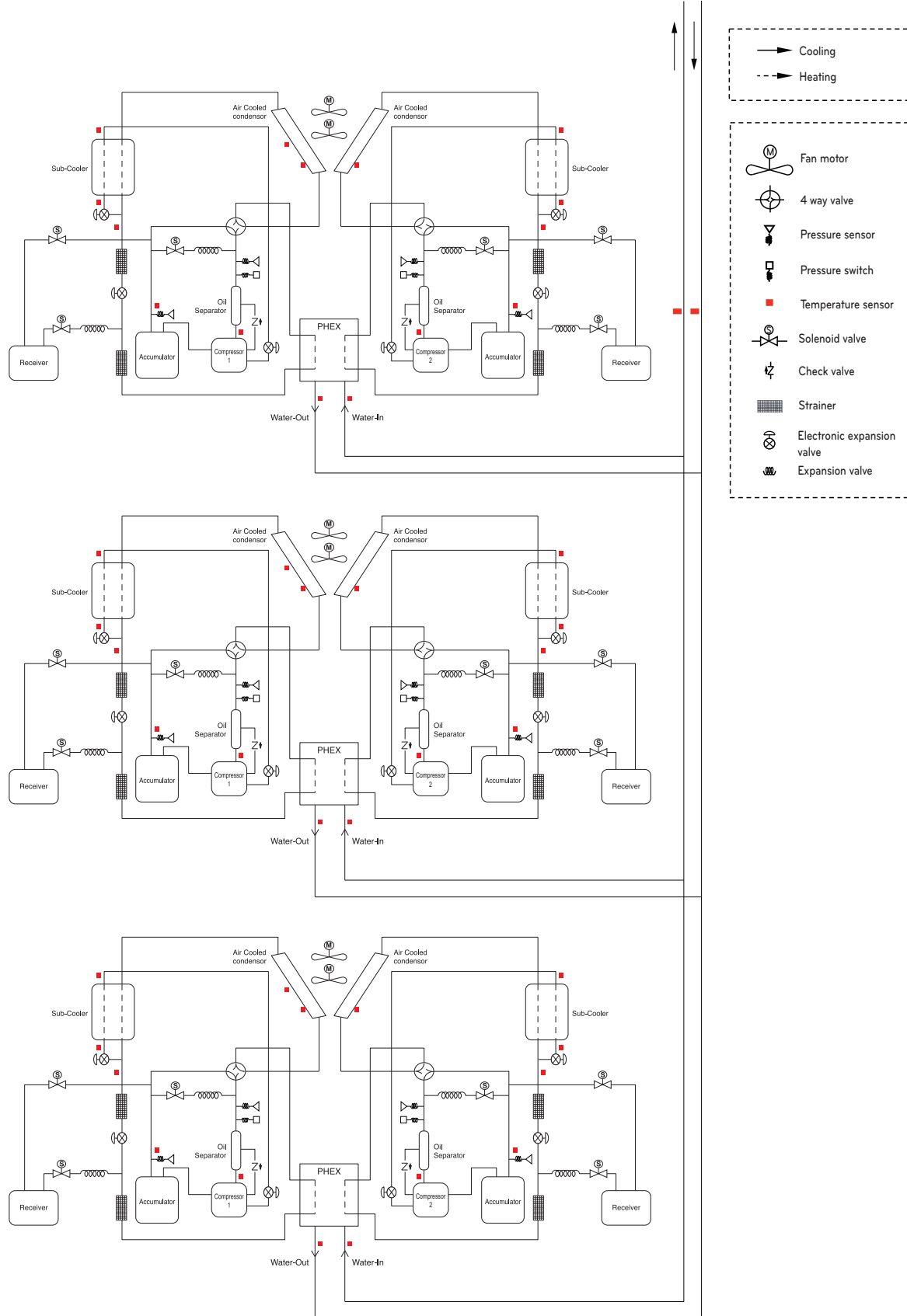

Air-Cooled Scroll Chiller (R410A)

13. Appendix – Sound Level

Sound Power Level

[dB(A)]

Model	Cooling	Heating
ACHH020LBAB	86	86
ACHH023LBAB	87	87
ACHH033LBAB	87	88
ACHH040LBAB	90	90
ACHH045LBAB	91	92
ACHH050LBAB	88	88
ACHH060LBAB	91	91
ACHH067LBAB	92	92

Note :

- Data is valid at diffuse field condition
- Data is valid at nominal operating condition
- Sound level can be increased in static pressure mode or used air guide.
- Sound power level is measured on the rated condition in the reverberation rooms.
- Sound level will vary depending on a range of factors such as the construction(acoustic absorption coefficient) of particular room in which the equipment is installed.
- Reference acoustic intensity $0\text{dB} = 10\text{E-}6\mu\text{W/m}^2$

ACHH020LBAB

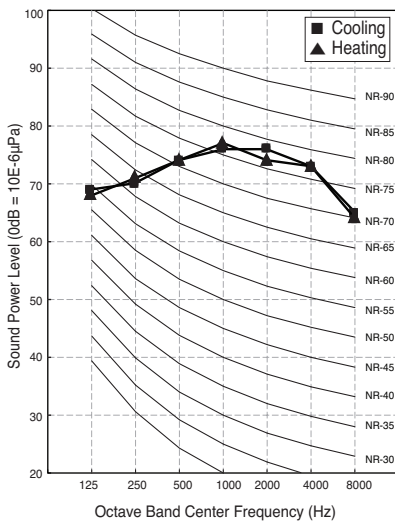

ACHH023LBAB

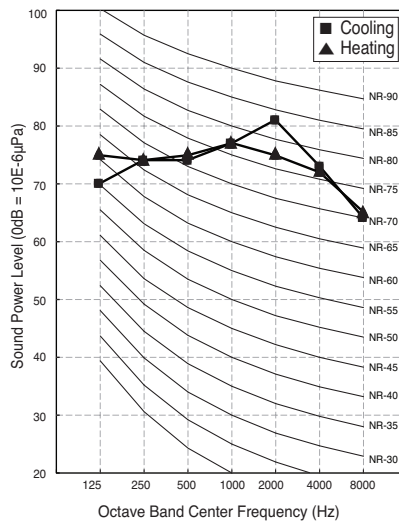

ACHH033LBAB

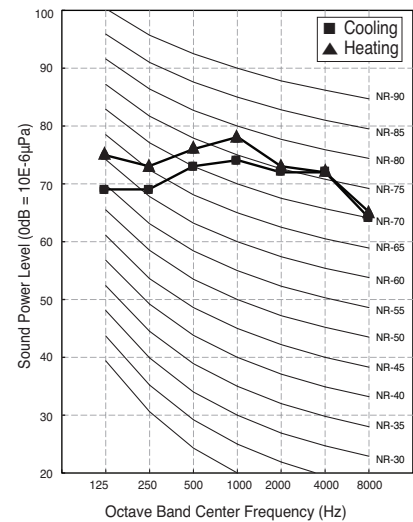

ACHH040LBAB

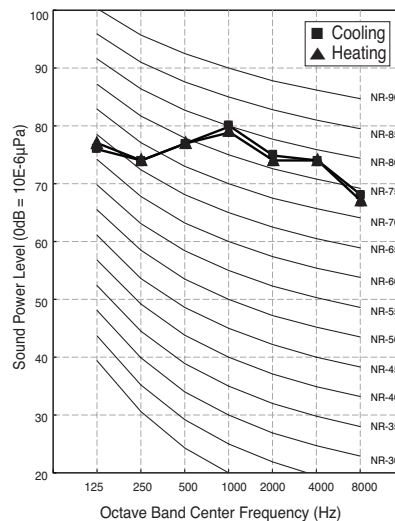

ACHH045LBAB

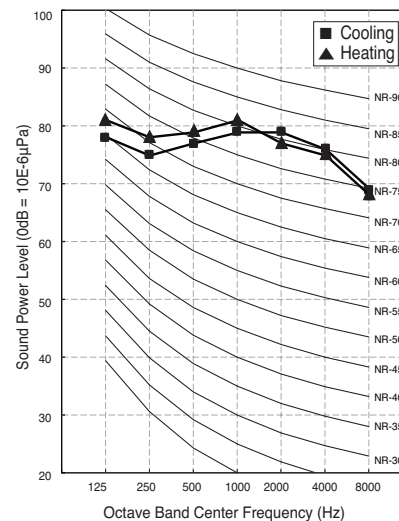

ACHH050LBAB

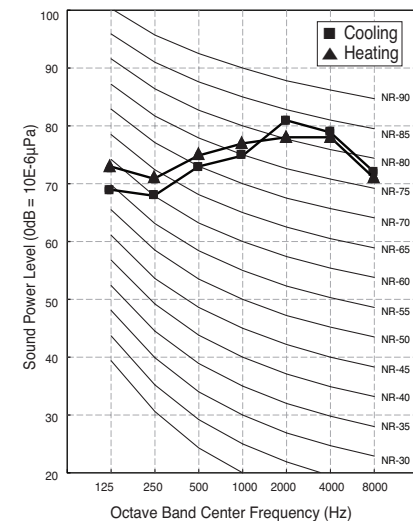

Air-Cooled Scroll Chiller (R410A)

13. Appendix – Sound Level

ACHH060LBAB

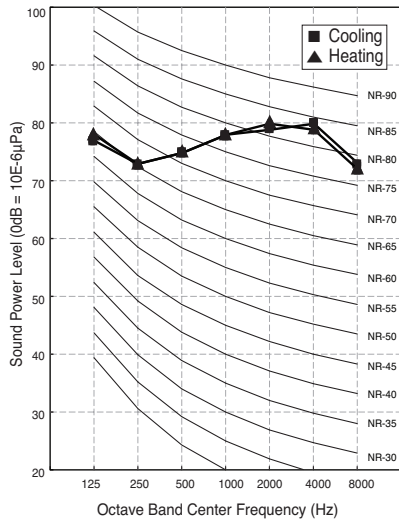

ACHH067LBAB

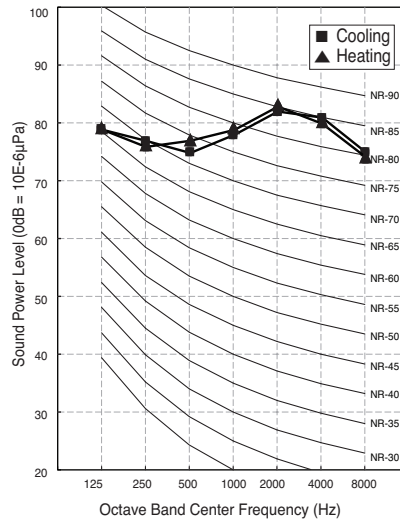

■ Sound Pressure Measurement Location

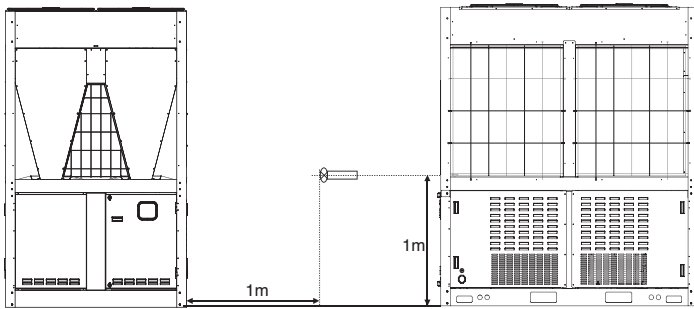



P/No.: MFL67285208



Air Solution

LG Electronics Inc, 128, Yeoui-daero,
Yeongdeungpo-gu, Seoul, Korea
(07336)
<http://partner.lge.com>

**Copyright © 2018-2022 LG Electronics
Inc. All Rights Reserved.**
Printed in Korea May / 2022

The air conditioners manufactured by LG have received ISO9001 certificate for quality assurance and ISO14001 certificate for environmental management system.
The specifications, designs, and information in this brochure are subject to change without notice.