

Air-Cooled Scroll Chiller

(R410A)

0BHW0-03D(Replaces 0BHW0-03C)

LG

TOTAL HVAC SOLUTION PROVIDER

ENGINEERING PRODUCT DATA BOOK

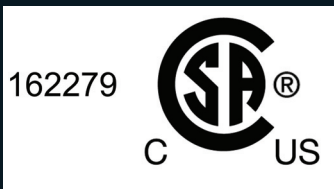

P/No. : MFL67285211

Air-Cooled Scroll Chiller (R410A)

- 1. Nomenclature**
- 2. Selection Procedure**
- 3. Specifications**
- 4. Performance Data**
- 5. Head loss of Cold water**
- 6. Dimensions**
- 7. Base of Installation**
- 8. Electric Characteristics**
- 9. Wiring Diagrams**
- 10. Installation of Chiller**
- 11. Specification of Production**
- 12. Appendix**

Air-Cooled Scroll Chiller (R410A)

1. Nomenclature

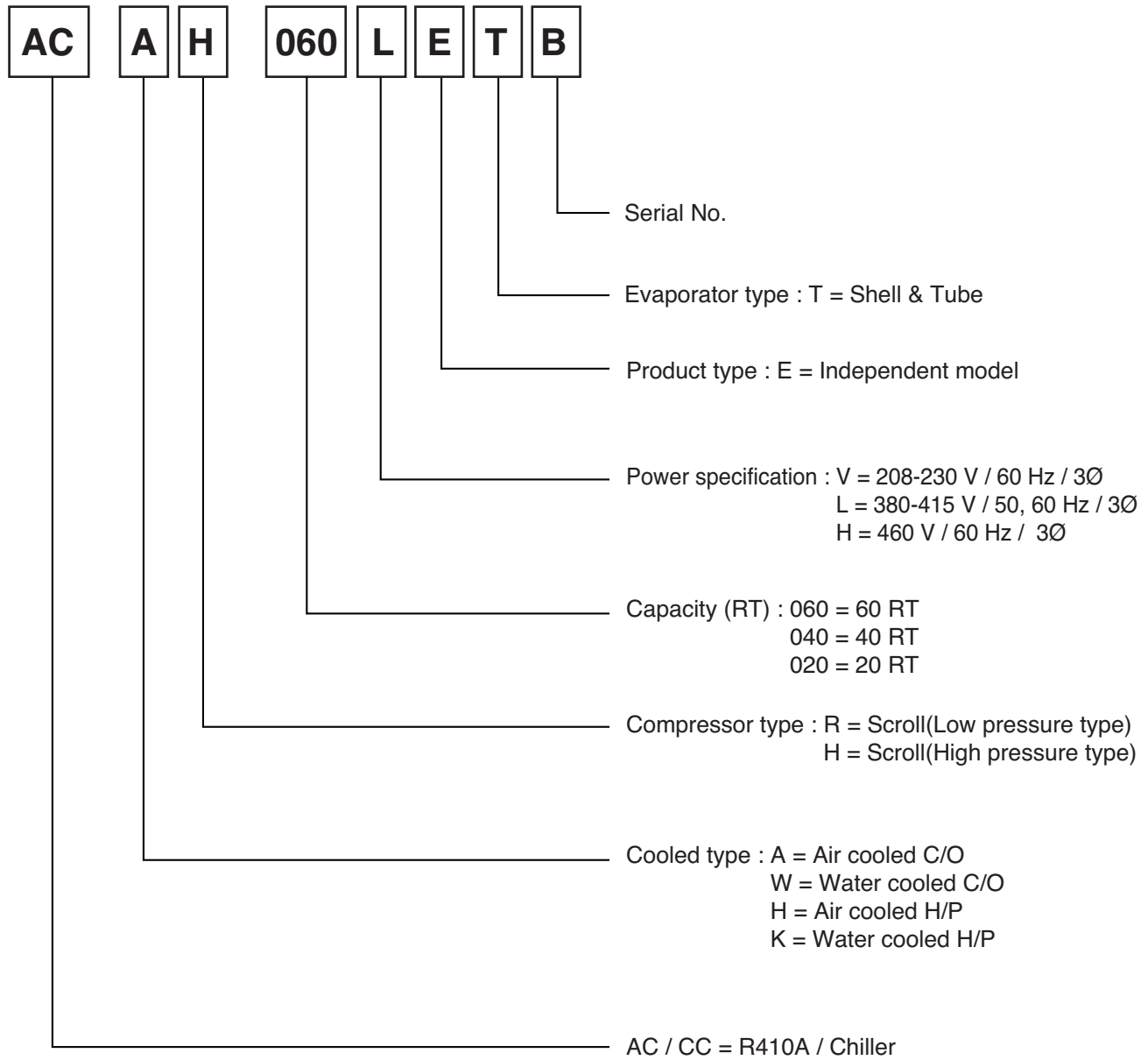

2. Selection Procedure

■ Selection guide

The product information required in various requirements is written in detail from Chapter 6.

If you need a product for special system application or product with the condition outside this PDB, please get consultation from nearby sales office or specialty store.

■ Selection procedure

1. Check usage condition

Before selecting the model, the following usage conditions must be decided.

- Cold and hot water in/out temperature and outdoor temperature
- Cold and hot water flow amount

(flow amount can be calculated if you know the freezing load and chilled water in/out temperature.)

2. Selecting candidate model

Required rated capability is selected through load calculation, and you can select the corresponding model by looking at Chapter 8 Cooling/heating capability change table.

When you select the candidate model, do not select a model with less volume than the required rated capability, but select a model with the same or bigger volume.

3. Performance adjustment for fouling

The data in this technical data manual is based on chilled water fouling coefficient of 0.000018 m²C/W.

4. Performance adjustment after adding freeze and burst prevention solution

If cooling operation is performed in Winter, or if water inside the cycle is not removed in the resting phase, you have to add freeze and burst prevention solution to protect from freeze and burst.

Freezer characteristics change by adding freeze and burst prevention solution, so it should be adjusted.

Refer to the following table for the adjustment coefficient after adding freeze and burst prevention solution.

Antifreeze Type	Item	Antifreeze % by wt				
		10 %	20 %	30 %	40 %	50 %
Methanol	Cooling	0.998	0.997	0.995	0.993	0.992
	Heating	0.995	0.990	0.985	0.979	0.974
	Pressure Drop	1.023	1.057	1.091	1.122	1.160
Ethylene glycol	Cooling	0.996	0.991	0.987	0.983	0.979
	Heating	0.993	0.985	0.977	0.969	0.961
	Pressure Drop	1.024	1.068	1.124	1.188	1.263
Propylene glycol	Cooling	0.993	0.987	0.980	0.974	0.968
	Heating	0.966	0.973	0.960	0.948	0.935
	Pressure Drop	1.040	1.098	1.174	1.273	1.405

2. Selection Procedure

5. Finalizing the model

As a result of verifying product performance and power consumption considering various adjustment coefficients for the candidate models, if there is no problem, you can finalize it as the final model.

If there is a problem, review again from the candidate model selection stage.

Determine inverter scroll chiller unit size and operating conditions required to meet given capacity at given conditions.

Step I

Given

Capacity : 115 kW

Leaving chilled water Temp : 7 °C

Cooler Water Temp different : 5 °C

Condenser Entering Ari temp : 35 °C

Fouling Factor : 0.018

Note: For other than approximately 6 to 8 °C temperature difference, unit selection must be made using the selection software.(LATS ISC). and contact LG consultant.

Step II

From chiller ratings table on page 7 to 24 and pressure drop curves on page 25, determine operating data for selected unit.

Unit : ACAH040LBAA

Capacity : 123 kW X fouling factor coefficient(1.0) = 123 kW (see 100% capacity table)

Power input : 46.4 kW X fouling factor coefficient(1.0) = 46.4 kW

Cooling water flow : 353 LPM

Pressure drop : 34 kPa

Note: If the chiller load is larger than the demand capacity, Check the partial load capacity table.

Step III

Review if the calculated specification is suitable for the site.

Air-Cooled Scroll Chiller (R410A)

3. Specifications

■ 208 - 230V

Inverter Scroll Chiller		Model	A(C)CAH020VETB	A(C)CAH033VETB	A(C)CAH040VETB
			C/O	C/O	C/O
Power		Phase,Lines,V	3,3,208-230	3,3,208-230	3,3,208-230
Capacity		kW	65	114	130
		RT	18.5	32.4	37
Input Power		kW	21.7	36.8	43.3
Efficiency		W/W	3.00	3.10	3.00
IPLV		W/W	5.0	5.1	5.0
Sound Pressure		dB(A)	64	66	67
Compressor	Type	-	Inverter Scroll	Inverter Scroll	Inverter Scroll
	No. of Compressor	EA	2	4	4
	Oil Type	-	FW68D(PVE)	FW68D(PVE)	FW68D(PVE)
	Oil charge	cc	1,400 x 2	1,400 x 4	1,400 x 4
Refrigerant	Type	-	R410A	R410A	R410A
	Amount of Charged	kg	6.5 x 2	6.5 x 4	6.5 x 4
Evaporator	Type	-	Shell&Tube	Shell&Tube	Shell&Tube
	Pressure drop	kPa	38.8	29.6	38.8
	Operating maximum pressure(Refrigerant / Water)	kg/cm ²	42/10	42/10	42/10
	Water Flow Rate (Standard)	LPM	186	327	372
	Inlet/Outlet diameter (Water pipe)	mm	50A/50A	65A/65A	65A/65A
Fan motor	Type	-	BLDC	BLDC	BLDC
	No. of Fan	EA	2	4	4
	No. of Vanes (per fan)	EA	6	6	6
	Air Flow Rate	CMM	246x2 @1,000rpm	246x4 @1,000rpm	246x4 @1,000rpm
	Motor power	W	900x2	900x4	900x4
Expansion unit		-	EEV	EEV	EEV
Weight		kg	560	1,034	1,034
Dimension	W	mm	765	1,528	1,528
	H	mm	2,200	2,200	2,200
	D	mm	2,154	2,154	2,154
Footprint		m ² /RT	0.089	0.102	0.089
Protection Devices	High/Low Pressure	-	○	○	○
	Anti Frost	-	○	○	○
Remote Control		-	Modbus	Modbus	Modbus
Outlet Temperature		°C	4~20	4~20	4~20
Ambient Temperature		°C	-15~48	-15~48	-15~48
Guaranteed Load Capacity Range		20 % ~ 100 %			

Notes:

- Due to our policy of innovation some specifications may be changed without prior notification.
- Capacities and Inputs are based on the following conditions
Cooling : Outdoor air temp. 35°C, Water inlet temp. 12°C, Water Outlet temp. 7°C
- The AHRI Certified® mark indicates LG Electronics participation in the AHRI Certification program. For verification of individual certified products, go to www.ahridirectory.org.
- The ACAH***VETB / ACAH***HETB models are certified by AHRI to AHRI Standard 550/590.
- Selection Software Name : LATS ISC
Selection Software Version no. : "For the latest version no. of selection software, go to www.ahridirectory.org."

Air-Cooled Scroll Chiller (R410A)

3. Specifications

Inverter Scroll Chiller		Model	A(C)CAH050VETB	A(C)CAH060VETB
			C/O	C/O
Power		Phase,Lines,V	3,3,208-230	3,3,208-230
Capacity		kW	171	195
		RT	48.6	55.4
Input Power		kW	55.2	65.0
Efficiency		W/W	3.10	3.00
IPLV		W/W	5.1	5.0
Sound Pressure		dB(A)	68	69
Compressor	Type	-	Inverter Scroll	Inverter Scroll
	No. of Compressor	EA	6	6
	Oil Type	-	FW68D(PVE)	FW68D(PVE)
	Oil charge	cc	1,400 x 6	1,400 x 6
Refrigrant	Type	-	R410A	R410A
	Amount of Charged	kg	6.5 x 6	6.5 x 6
Evaporator	Type	-	Shell&Tube	Shell&Tube
	Pressure drop	kPa	29.6	38.8
	Operating maximum pressure(Refrigrant / Water)	kg/cm ²	42/10	42/10
	Water Flow Rate (Standard)	LPM	491	558
	Inlet/Outlet diameter (Water pipe)	mm	65A/65A	65A/65A
Fan motor	Type	-	BLDC	BLDC
	No. of Fan	EA	6	6
	No. of Vanes (per fan)	EA	6	6
	Air Flow Rate	CMM	246x6 @1,000rpm	246x6 @1,000rpm
	Motor power	W	900x6	900x6
Expansion unit		-	EEV	EEV
Weight		kg	1,522	1,522
Dimension	W	mm	2,291	2,291
	H	mm	2,200	2,200
	D	mm	2,154	2,154
Footprint		m ² /RT	0.101	0.089
Protection Devices	High/Low Pressure	-	○	○
	Anti Frost	-	○	○
Remote Control		-	Modbus	Modbus
Outlet Temperature		°C	4~20	4~20
Ambient Temperature		°C	-15~48	-15~48
Guaranteed Load Capacity Range			20 % ~ 100 %	

Notes:

- Due to our policy of innovation some specifications may be changed without prior notification.
- Capacities and Inputs are based on the following conditions
Cooling : Outdoor air temp. 35°C, Water inlet temp. 12°C, Water Outlet temp. 7°C
- The AHRI Certified® mark indicates LG Electronics participation in the AHRI Certification program. For verification of individual certified products, go to www.ahridirectory.org.
- The ACAH***VETB / ACAH***HETB models are certified by AHRI to AHRI Standard 550/590.
- Selection Software Name : LATS ISC
Selection Software Version no. : "For the latest version no. of selection software, go to www.ahridirectory.org."

Air-Cooled Scroll Chiller (R410A)

3. Specifications

■ 380 - 415V

Inverter Scroll Chiller		Model	A(C)CAH020LETB	A(C)CAH023LETB	A(C)CAH033LETB
			C/O	C/O	C/O
Power		Phase,Lines,V	3,4,380-415	3,4,380-415	3,4,380-415
Capacity		kW	65	74	114
		RT	18.5	21.0	32.4
Input Power		kW	21.5	28.5	36.2
Efficiency		W/W	3.02	2.60	3.15
IPLV		W/W	5.3	5.1	5.4
Sound Pressure		dB(A)	64	66	66
Compressor	Type	-	Inverter Scroll	Inverter Scroll	Inverter Scroll
	No. of Compressor	EA	2	2	4
	Oil Type	-	FW68D(PVE)	FW68D(PVE)	FW68D(PVE)
	Oil charge	cc	1,400 x 2	1,400 x 2	1,400 x 4
Refrigrant	Type	-	R410A	R410A	R410A
	Amount of Charged	kg	6.5 x 2	6.5 x 2	6.5 x 4
Evaporator	Type	-	Shell&Tube	Shell&Tube	Shell&Tube
	Pressure drop	kPa	38.8	49.2	29.6
	Operating maximum pressure(Refrigrant / Water)	kg/cm ²	42/10	42/10	42/10
	Water Flow Rate (Standard)	LPM	186	211	327
	Inlet/Outlet diameter (Water pipe)	mm	50A/50A	50A/50A	65A/65A
Fan motor	Type	-	BLDC	BLDC	BLDC
	No. of Fan	EA	2	2	4
	No. of Vanes (per fan)	EA	6	6	6
	Air Flow Rate	CMM	246 x 2 @1,000rpm	246 x 2 @1,000rpm	246 x 4 @1,000rpm
	Motor power	W	900 x 2	900 x 2	900 x 4
Expansion unit		-	EEV	EEV	EEV
Weight		kg	560	560	1,034
Dimension	W	mm	765	765	1,528
	H	mm	2,200	2,200	2,200
	D	mm	2,154	2,154	2,154
Footprint		m ² /RT	0.089	0.078	0.102
Protection Devices	High/Low Pressure	-	○	○	○
	Anti Frost	-	○	○	○
Remote Control		-	Modbus	Modbus	Modbus
Outlet Temperature		°C	4~20	4~20	4~20
Ambient Temperature		°C	-15~48	-15~48	-15~48
Guaranteed Load Capacity Range		20 % ~ 100 %			

Notes:

1. Due to our policy of innovation some specifications may be changed without prior notification.
2. Capacities and Inputs are based on the following conditions
Cooling : Outdoor air temp. 35°C, Water inlet temp. 12°C, Water Outlet temp. 7°C
3. The AHRI Certified® mark indicates LG Electronics participation in the AHRI Certification program. For verification of individual certified products, go to www.ahridirectory.org.
4. The ACAH***VETB / ACAH***HETB models are certified by AHRI to AHRI Standard 550/590.

Air-Cooled Scroll Chiller (R410A)

3. Specifications

Inverter Scroll Chiller		Model	A(C)CAH040LETB	A(C)CAH045LETB	A(C)CAH050LETB
			C/O	C/O	C/O
Power		Phase,Lines,V	3,4,380-415	3,4,380-415	3,4,380-415
Capacity		kW	130	148	171
		RT	37.0	42.1	48.6
Input Power		kW	43.0	56.9	54.3
Efficiency		W/W	3.02	2.60	3.15
IPLV		W/W	5.3	5.1	5.4
Sound Pressure		dB(A)	67	69	68
Compressor	Type	-	Inverter Scroll	Inverter Scroll	Inverter Scroll
	No. of Compressor	EA	4	4	6
	Oil Type	-	FW68D(PVE)	FW68D(PVE)	FW68D(PVE)
	Oil charge	cc	1,400 x 4	1,400 x 4	1,400 x 6
Refrigrant	Type	-	R410A	R410A	R410A
	Amount of Charged	kg	6.5 x 4	6.5 x 4	6.5 x 6
Evaporator	Type	-	Shell&Tube	Shell&Tube	Shell&Tube
	Pressure drop	kPa	38.8	49.2	29.6
	Operating maximum pressure(Refrigrant / Water)	kg/cm ²	42/10	42/10	42/10
	Water Flow Rate (Standard)	LPM	372	422	491
	Inlet/Outlet diameter (Water pipe)	mm	65A/65A	65A/65A	65A/65A
Fan motor	Type	-	BLDC	BLDC	BLDC
	No. of Fan	EA	4	4	6
	No. of Vanes (per fan)	EA	6	6	6
	Air Flow Rate	CMM	246 x 4 @1,000rpm	246 x 4 @1,000rpm	246 x 6 @1,000rpm
	Motor power	W	900 x 4	900 x 4	900 x 6
Expansion unit		-	EEV	EEV	EEV
Weight		kg	1,034	1,034	1,522
Dimension	W	mm	1,528	1,528	2,291
	H	mm	2,200	2,200	2,200
	D	mm	2,154	2,154	2,154
Footprint		m ² /RT	0.089	0.078	0.101
Protection Devices	High/Low Pressure	-	○	○	○
	Anti Frost	-	○	○	○
Remote Control		-	Modbus	Modbus	Modbus
Outlet Temperature		°C	4~20	4~20	4~20
Ambient Temperature		°C	-15~48	-15~48	-15~48
Guaranteed Load Capacity Range			20 % ~ 100 %		

Notes:

- Due to our policy of innovation some specifications may be changed without prior notification.
- Capacities and Inputs are based on the following conditions
Cooling : Outdoor air temp. 35°C, Water inlet temp. 12°C, Water Outlet temp. 7°C
- The AHRI Certified® mark indicates LG Electronics participation in the AHRI Certification program. For verification of individual certified products, go to www.ahridirectory.org.
- The ACAH***VETB / ACAH***HETB models are certified by AHRI to AHRI Standard 550/590.

Air-Cooled Scroll Chiller (R410A)

3. Specifications

Inverter Scroll Chiller		Model	A(C)CAH060LETB	A(C)CAH067LETB
			C/O	C/O
Power		Phase,Lines,V	3,4,380-415	3,4,380-415
Capacity		kW	195	222
		RT	55.4	63.1
Input Power		kW	64.6	85.4
Efficiency		W/W	3.02	2.60
IPLV		W/W	5.3	5.1
Sound Pressure		dB(A)	69	71
Compressor	Type	-	Inverter Scroll	Inverter Scroll
	No. of Compressor	EA	6	6
	Oil Type	-	FW68D(PVE)	FW68D(PVE)
	Oil charge	cc	1,400 x 6	1,400 x 6
Refrigrant	Type	-	R410A	R410A
	Amount of Charged	kg	6.5 x 6	6.5 x 6
Evaporator	Type	-	Shell&Tube	Shell&Tube
	Pressure drop	kPa	38.8	49.2
	Operating maximum pressure(Refrigrant / Water)	kg/cm ²	42/10	42/10
	Water Flow Rate (Standard)	LPM	558	633
	Inlet/Outlet diameter (Water pipe)	mm	65A/65A	65A/65A
Fan motor	Type	-	BLDC	BLDC
	No. of Fan	EA	6	6
	No. of Vanes (per fan)	EA	6	6
	Air Flow Rate	CMM	246 x 6 @1,000rpm	246 x 6 @1,000rpm
	Motor power	W	900 x 6	900 x 6
Expansion unit		-	EEV	EEV
Weight		kg	1,522	1,522
Dimension	W	mm	2,291	2,291
	H	mm	2,200	2,200
	D	mm	2,154	2,154
Footprint		m ² /RT	0.089	0.078
Protection Devices	High/Low Pressure	-	○	○
	Anti Frost	-	○	○
Remote Control		-	Modbus	Modbus
Outlet Temperature		°C	4~20	4~20
Ambient Temperature		°C	-15~48	-15~48
Guaranteed Load Capacity Range			20 % ~ 100 %	

Notes:

1. Due to our policy of innovation some specifications may be changed without prior notification.
2. Capacities and Inputs are based on the following conditions
Cooling : Outdoor air temp. 35°C, Water inlet temp. 12°C, Water Outlet temp. 7°C
3. The AHRI Certified® mark indicates LG Electronics participation in the AHRI Certification program. For verification of individual certified products, go to www.ahridirectory.org.
4. The ACAH***VETB / ACAH***HETB models are certified by AHRI to AHRI Standard 550/590.

Air-Cooled Scroll Chiller (R410A)

3. Specifications

■ 460V

Inverter Scroll Chiller		Model	ACAH020HETB	ACAH023HETB	ACAH033HETB
			C/O	C/O	C/O
Power		Phase,Lines,V	3,3,460	3,3,460	3,3,460
Capacity		kW	65	74	114
		RT	18.5	21.0	32.4
Input Power		kW	21.5	28.5	36.2
Efficiency		W/W	3.02	2.60	3.15
IPLV		W/W	5.3	5.1	5.4
Sound Pressure		dB(A)	64	66	66
Compressor	Type	-	Inverter Scroll	Inverter Scroll	Inverter Scroll
	No. of Compressor	EA	2	2	4
	Oil Type	-	FW68D(PVE)	FW68D(PVE)	FW68D(PVE)
	Oil charge	cc	1,400 x 2	1,400 x 2	1,400 x 4
Refrigrant	Type	-	R410A	R410A	R410A
	Amount of Charged	kg	6.5 x 2	6.5 x 2	6.5 x 4
Evaporator	Type	-	Shell&Tube	Shell&Tube	Shell&Tube
	Pressure drop	kPa	38.8	49.2	29.6
	Operating maximum pressure(Refrigrant / Water)	kg/cm ²	42/10	42/10	42/10
	Water Flow Rate (Standard)	LPM	186	211	327
	Inlet/Outlet diameter (Water pipe)	mm	50A/50A	50A/50A	65A/65A
Fan motor	Type	-	BLDC	BLDC	BLDC
	No. of Fan	EA	2	2	4
	No. of Vanes (per fan)	EA	6	6	6
	Air Flow Rate	CMM	246 x 2 @1,000rpm	246 x 2 @1,000rpm	246 x 4 @1,000rpm
	Motor power	W	900 x 2	900 x 2	900 x 4
Expansion unit		-	EEV	EEV	EEV
Weight		kg	560	560	1,034
Dimension	W	mm	765	765	1,528
	H	mm	2,200	2,200	2,200
	D	mm	2,154	2,154	2,154
Footprint		m ² /RT	0.089	0.078	0.102
Protection Devices	High/Low Pressure	-	○	○	○
	Anti Frost	-	○	○	○
Remote Control		-	Modbus	Modbus	Modbus
Outlet Temperature		°C	4~20	4~20	4~20
Ambient Temperature		°C	-15~48	-15~48	-15~48
Guaranteed Load Capacity Range		20 % ~ 100 %			

Notes:

- Due to our policy of innovation some specifications may be changed without prior notification.
- Capacities and Inputs are based on the following conditions
Cooling : Outdoor air temp. 35°C, Water inlet temp. 12°C, Water Outlet temp. 7°C
- The AHRI Certified® mark indicates LG Electronics participation in the AHRI Certification program. For verification of individual certified products, go to www.ahridirectory.org.
- The ACAH****VETB / ACAH****HETB models are certified by AHRI to AHRI Standard 550/590.
- Selection Software Name : LATS ISC
Selection Software Version no. : "For the latest version no. of selection software, go to www.ahridirectory.org."

Air-Cooled Scroll Chiller (R410A)

3. Specifications

Inverter Scroll Chiller		Model	ACAH040HETB	ACAH045HETB	ACAH050HETB
			C/O	C/O	C/O
Power		Phase,Lines,V	3,3,460	3,3,460	3,3,460
Capacity		kW	130	148	171
		RT	37.0	42.1	48.6
Input Power		kW	43.0	56.9	54.3
Efficiency		W/W	3.02	2.60	3.15
IPLV		W/W	5.3	5.1	5.4
Sound Pressure		dB(A)	67	69	68
Compressor	Type	-	Inverter Scroll	Inverter Scroll	Inverter Scroll
	No. of Compressor	EA	4	4	6
	Oil Type	-	FW68D(PVE)	FW68D(PVE)	FW68D(PVE)
	Oil charge	cc	1,400 x 4	1,400 x 4	1,400 x 6
Refrigrant	Type	-	R410A	R410A	R410A
	Amount of Charged	kg	6.5 x 4	6.5 x 4	6.5 x 6
Evaporator	Type	-	Shell&Tube	Shell&Tube	Shell&Tube
	Pressure drop	kPa	38.8	49.2	29.6
	Operating maximum pressure(Refrigrant / Water)	kg/cm ²	42/10	42/10	42/10
	Water Flow Rate (Standard)	LPM	372	422	491
	Inlet/Outlet diameter (Water pipe)	mm	65A/65A	65A/65A	65A/65A
Fan motor	Type	-	BLDC	BLDC	BLDC
	No. of Fan	EA	4	4	6
	No. of Vanes (per fan)	EA	6	6	6
	Air Flow Rate	CMM	246 x 4 @1,000rpm	246 x 4 @1,000rpm	246 x 6 @1,000rpm
	Motor power	W	900 x 4	900 x 4	900 x 6
Expansion unit		-	EEV	EEV	EEV
Weight		kg	1,034	1,034	1,522
Dimension	W	mm	1,528	1,528	2,291
	H	mm	2,200	2,200	2,200
	D	mm	2,154	2,154	2,154
Footprint		m ² /RT	0.089	0.078	0.101
Protection Devices	High/Low Pressure	-	○	○	○
	Anti Frost	-	○	○	○
Remote Control		-	Modbus	Modbus	Modbus
Outlet Temperature		°C	4~20	4~20	4~20
Ambient Temperature		°C	-15~48	-15~48	-15~48
Guaranteed Load Capacity Range			20 % ~ 100 %		

Notes:

1. Due to our policy of innovation some specifications may be changed without prior notification.
2. Capacities and Inputs are based on the following conditions
Cooling : Outdoor air temp. 35°C, Water inlet temp. 12°C, Water Outlet temp. 7°C
3. The AHRI Certified® mark indicates LG Electronics participation in the AHRI Certification program. For verification of individual certified products, go to www.ahridirectory.org.
4. The ACAH***VETB / ACAH***HETB models are certified by AHRI to AHRI Standard 550/590.
5. Selection Software Name : LATS ISC
Selection Software Version no. : "For the latest version no. of selection software, go to www.ahridirectory.org."

Air-Cooled Scroll Chiller (R410A)

3. Specifications

Inverter Scroll Chiller		Model	ACAH060HETB	ACAH067HETB
			C/O	C/O
Power		Phase,Lines,V	3,3,460	3,3,460
Capacity		kW	195	222
		RT	55.4	63.1
Input Power		kW	64.6	85.4
Efficiency		W/W	3.02	2.60
IPLV		W/W	5.3	5.1
Sound Pressure		dB(A)	69	71
Compressor	Type	-	Inverter Scroll	Inverter Scroll
	No. of Compressor	EA	6	6
	Oil Type	-	FW68D(PVE)	FW68D(PVE)
	Oil charge	cc	1,400 x 6	1,400 x 6
Refrigrant	Type	-	R410A	R410A
	Amount of Charged	kg	6.5 x 6	6.5 x 6
Evaporator	Type	-	Shell&Tube	Shell&Tube
	Pressure drop	kPa	38.8	49.2
	Operating maximum pressure(Refrigrant / Water)	kg/cm ²	42/10	42/10
	Water Flow Rate (Standard)	LPM	558	633
	Inlet/Outlet diameter (Water pipe)	mm	65A/65A	65A/65A
Fan motor	Type	-	BLDC	BLDC
	No. of Fan	EA	6	6
	No. of Vanes (per fan)	EA	6	6
	Air Flow Rate	CMM	246 x 6 @1,000rpm	246 x 6 @1,000rpm
	Motor power	W	900 x 6	900 x 6
Expansion unit		-	EEV	EEV
Weight		kg	1,522	1,522
Dimension	W	mm	2,291	2,291
	H	mm	2,200	2,200
	D	mm	2,154	2,154
Footprint		m ² /RT	0.089	0.078
Protection Devices	High/Low Pressure	-	○	○
	Anti Frost	-	○	○
Remote Control		-	Modbus	Modbus
Outlet Temperature		°C	4~20	4~20
Ambient Temperature		°C	-15~48	-15~48
Guaranteed Load Capacity Range			20 % ~ 100 %	

Notes:

1. Due to our policy of innovation some specifications may be changed without prior notification.
2. Capacities and Inputs are based on the following conditions
Cooling : Outdoor air temp. 35°C, Water inlet temp. 12°C, Water Outlet temp. 7°C
3. The AHRI Certified® mark indicates LG Electronics participation in the AHRI Certification program. For verification of individual certified products, go to www.ahridirectory.org.
4. The ACAH***VETB / ACAH***HETB models are certified by AHRI to AHRI Standard 550/590.
5. Selection Software Name : LATS ISC
Selection Software Version no. : "For the latest version no. of selection software, go to www.ahridirectory.org."

Air-Cooled Scroll Chiller (R410A)

4. Performance Data

■ 208 - 230V

■ A(C)CAH020VETB ($\Delta T = 5^{\circ}\text{C}$)

Flow Rate		Outdoor Temperature ($^{\circ}\text{C}$)													
		-15		-10		-5		0		5		10		15	
186 LPM		Capacity (W)	Power Input (W)	Capacity (W)	Power Input (W)	Capacity (W)	Power Input (W)	Capacity (W)	Power Input (W)	Capacity (W)	Power Input (W)	Capacity (W)	Power Input (W)	Capacity (W)	Power Input (W)
Outlet Water Temp. ($^{\circ}\text{C}$)	-10	44,000	10,648	44,000	10,665	44,000	10,734	44,000	10,798	44,000	10,935	44,000	11,782	42,367	12,868
	-5	52,164	11,362	52,164	11,380	52,164	11,453	52,164	11,521	52,164	11,668	52,164	12,572	52,164	14,313
	0	61,110	11,979	61,110	11,998	61,110	12,076	61,110	12,147	61,110	12,302	61,110	13,255	61,110	15,091
	5	65,000	10,104	65,000	10,121	65,000	10,186	65,000	10,247	65,000	10,378	65,000	11,187	65,000	12,747
	7	65,000	9,415	65,000	9,432	65,000	9,493	65,000	9,550	65,000	9,674	65,000	10,438	65,000	11,915
	9	65,000	9,355	65,000	9,370	65,000	9,431	65,000	9,486	65,000	9,604	65,000	10,335	65,000	11,740
	11	65,000	9,294	65,000	9,309	65,000	9,369	65,000	9,422	65,000	9,536	65,000	10,235	65,000	11,570
	13	65,000	9,174	65,000	9,189	65,000	9,248	65,000	9,300	65,000	9,409	65,000	10,081	65,000	11,362
	15	65,000	9,058	65,000	9,072	65,000	9,131	65,000	9,180	65,000	9,285	65,000	9,932	65,000	11,158
	20	65,000	8,955	65,000	8,969	65,000	9,027	65,000	9,072	65,000	9,166	65,000	9,749	65,000	10,839

Flow Rate		Outdoor Temperature ($^{\circ}\text{C}$)													
		20		25		30		35		40		45		48	
186 LPM		Capacity (W)	Power Input (W)	Capacity (W)	Power Input (W)	Capacity (W)	Power Input (W)	Capacity (W)	Power Input (W)	Capacity (W)	Power Input (W)	Capacity (W)	Power Input (W)	Capacity (W)	Power Input (W)
Outlet Water Temp. ($^{\circ}\text{C}$)	-10	39,553	13,956	38,720	15,848	38,720	18,072	37,889	20,688	36,786	23,234	31,261	22,966	24,164	18,936
	-5	51,689	16,414	50,600	18,639	50,600	21,255	49,514	24,332	45,851	26,063	39,419	26,063	31,578	22,271
	0	61,110	17,485	61,110	20,260	61,110	23,102	58,006	25,655	50,945	26,063	43,799	26,063	36,993	23,482
	5	65,000	14,784	65,000	17,151	65,000	19,582	65,000	22,949	63,676	26,063	54,616	26,063	43,454	22,118
	7	65,000	13,852	65,000	16,113	65,000	18,445	65,000	21,700	65,000	25,254	56,993	26,063	45,902	22,382
	9	65,000	13,562	65,000	15,662	65,000	17,799	65,000	20,724	65,000	23,868	59,251	25,101	47,653	21,460
	11	65,000	13,285	65,000	15,236	65,000	17,197	65,000	19,832	65,000	22,626	60,500	24,147	49,405	20,808
	13	65,000	12,995	65,000	14,839	65,000	16,677	65,000	19,120	65,000	21,690	61,587	23,393	50,928	20,289
	15	65,000	12,711	65,000	14,451	65,000	16,171	65,000	18,432	65,000	20,793	61,750	22,320	51,988	19,637
	20	65,000	12,190	65,000	13,666	65,000	15,087	65,000	16,890	65,000	18,737	61,750	19,377	54,530	18,270

Air-Cooled Scroll Chiller (R410A)

4. Performance Data

■ A(C)CAH020VETB ($\Delta T = 7^{\circ}\text{C}$)

Flow Rate		Outdoor Temperature ($^{\circ}\text{C}$)													
		-15		-10		-5		0		5		10		15	
137 LPM		Capacity (W)	Power Input (W)	Capacity (W)	Power Input (W)	Capacity (W)	Power Input (W)	Capacity (W)	Power Input (W)	Capacity (W)	Power Input (W)	Capacity (W)	Power Input (W)	Capacity (W)	Power Input (W)
Outlet Water Temp. ($^{\circ}\text{C}$)	-10	45,276	10,701	45,276	10,719	45,276	10,788	45,276	10,852	45,276	10,990	45,276	11,841	43,595	12,932
	-5	53,677	11,418	53,677	11,437	53,677	11,510	53,677	11,579	53,677	11,726	53,677	12,634	53,677	14,384
	0	62,882	12,039	62,882	12,058	62,882	12,136	62,882	12,208	62,882	12,364	62,882	13,321	62,882	15,166
	5	66,885	10,154	66,885	10,171	66,885	10,237	66,885	10,298	66,885	10,430	66,885	11,243	66,885	12,810
	7	66,885	9,462	66,885	9,479	66,885	9,540	66,885	9,598	66,885	9,723	66,885	10,491	66,885	11,975
	9	66,885	9,402	66,885	9,417	66,885	9,478	66,885	9,533	66,885	9,653	66,885	10,387	66,885	11,799
	11	66,885	9,340	66,885	9,355	66,885	9,416	66,885	9,469	66,885	9,583	66,885	10,286	66,885	11,628
	13	66,885	9,220	66,885	9,235	66,885	9,294	66,885	9,346	66,885	9,456	66,885	10,132	66,885	11,419
	15	66,885	9,103	66,885	9,117	66,885	9,176	66,885	9,226	66,885	9,332	66,885	9,981	66,885	11,213
	20	66,885	8,999	66,885	9,014	66,885	9,072	66,885	9,117	66,885	9,212	66,885	9,797	66,885	10,893

Flow Rate		Outdoor Temperature ($^{\circ}\text{C}$)													
		20		25		30		35		40		45		48	
137 LPM		Capacity (W)	Power Input (W)	Capacity (W)	Power Input (W)	Capacity (W)	Power Input (W)	Capacity (W)	Power Input (W)	Capacity (W)	Power Input (W)	Capacity (W)	Power Input (W)	Capacity (W)	Power Input (W)
Outlet Water Temp. ($^{\circ}\text{C}$)	-10	40,701	14,026	39,843	15,927	39,843	18,162	38,988	20,792	37,853	23,350	32,168	23,080	24,865	19,031
	-5	53,188	16,496	52,067	18,733	52,067	21,361	50,950	24,454	46,946	26,063	40,361	26,063	32,494	22,383
	0	62,882	17,572	62,882	20,361	62,882	23,218	59,688	25,783	52,162	26,063	44,845	26,063	38,066	23,599
	5	66,885	14,858	66,885	17,237	66,885	19,680	66,885	23,064	65,197	26,063	55,920	26,063	44,714	22,228
	7	66,885	13,922	66,885	16,193	66,885	18,538	66,885	21,758	66,885	25,381	58,353	26,063	47,233	22,493
	9	66,885	13,630	66,885	15,740	66,885	17,888	66,885	20,828	66,885	23,987	60,969	25,227	49,035	21,568
	11	66,885	13,351	66,885	15,312	66,885	17,283	66,885	19,931	66,885	22,739	62,255	24,268	50,838	20,912
	13	66,885	13,060	66,885	14,913	66,885	16,761	66,885	19,216	66,885	21,798	63,373	23,510	52,405	20,390
	15	66,885	12,774	66,885	14,523	66,885	16,252	66,885	18,524	66,885	20,897	63,541	22,431	53,496	19,735
	20	66,885	12,251	66,885	13,734	66,885	15,163	66,885	16,975	66,885	18,830	63,541	19,474	56,112	18,362

Air-Cooled Scroll Chiller (R410A)

4. Performance Data

■ A(C)CAH020VETB ($\Delta T = 10^{\circ}\text{C}$)

Flow Rate		Outdoor Temperature ($^{\circ}\text{C}$)													
100 LPM		-15		-10		-5		0		5		10		15	
		Capacity (W)	Power Input (W)	Capacity (W)	Power Input (W)	Capacity (W)	Power Input (W)	Capacity (W)	Power Input (W)	Capacity (W)	Power Input (W)	Capacity (W)	Power Input (W)	Capacity (W)	Power Input (W)
Outlet Water Temp. ($^{\circ}\text{C}$)	-10	47,168	10,787	47,168	10,804	47,168	10,874	47,168	10,938	47,168	11,077	47,168	11,935	45,417	13,035
	-5	55,920	11,509	55,920	11,528	55,920	11,602	55,920	11,671	55,920	11,820	55,920	12,735	55,920	14,499
	0	65,510	12,135	65,510	12,154	65,510	12,233	65,510	12,305	65,510	12,462	65,510	13,427	65,510	15,287
	5	69,680	10,235	69,680	10,252	69,680	10,318	69,680	10,380	69,680	10,513	69,680	11,332	69,680	12,912
	7	69,680	9,537	69,680	9,555	69,680	9,616	69,680	9,674	69,680	9,800	69,680	10,574	69,680	12,070
	9	69,680	9,477	69,680	9,492	69,680	9,553	69,680	9,609	69,680	9,729	69,680	10,470	69,680	11,893
	11	69,680	9,415	69,680	9,430	69,680	9,491	69,680	9,544	69,680	9,660	69,680	10,368	69,680	11,720
	13	69,680	9,294	69,680	9,308	69,680	9,368	69,680	9,420	69,680	9,531	69,680	10,213	69,680	11,509
	15	69,680	9,175	69,680	9,190	69,680	9,249	69,680	9,299	69,680	9,406	69,680	10,061	69,680	11,303
	20	69,680	9,071	69,680	9,085	69,680	9,144	69,680	9,190	69,680	9,286	69,680	9,875	69,680	10,980

Flow Rate		Outdoor Temperature ($^{\circ}\text{C}$)													
100 LPM		20		25		30		35		40		45		48	
		Capacity (W)	Power Input (W)	Capacity (W)	Power Input (W)	Capacity (W)	Power Input (W)	Capacity (W)	Power Input (W)	Capacity (W)	Power Input (W)	Capacity (W)	Power Input (W)	Capacity (W)	Power Input (W)
Outlet Water Temp. ($^{\circ}\text{C}$)	-10	42,401	14,137	41,508	16,054	41,508	18,306	40,617	20,957	39,435	23,536	33,512	23,264	25,904	19,182
	-5	55,411	16,627	54,243	18,882	54,243	21,531	53,079	24,649	48,522	26,063	41,715	26,063	33,851	22,561
	0	65,510	17,712	65,510	20,523	65,510	23,403	62,182	25,988	53,913	26,063	46,350	26,063	39,657	23,787
	5	69,680	14,977	69,680	17,374	69,680	19,836	69,680	23,247	67,385	26,063	57,797	26,063	46,582	22,405
	7	69,680	14,033	69,680	16,322	69,680	18,685	69,680	21,932	69,680	25,583	60,312	26,063	49,207	22,672
	9	69,680	13,739	69,680	15,865	69,680	18,031	69,680	20,993	69,680	24,178	63,517	25,428	51,084	21,739
	11	69,680	13,457	69,680	15,434	69,680	17,420	69,680	20,090	69,680	22,920	64,856	24,461	52,962	21,078
	13	69,680	13,164	69,680	15,032	69,680	16,894	69,680	19,369	69,680	21,972	66,021	23,697	54,595	20,552
	15	69,680	12,876	69,680	14,639	69,680	16,381	69,680	18,672	69,680	21,063	66,196	22,610	55,731	19,892
	20	69,680	12,349	69,680	13,844	69,680	15,283	69,680	17,110	69,680	18,980	66,196	19,629	58,457	18,508

Air-Cooled Scroll Chiller (R410A)

4. Performance Data

■ A(C)CAH033VETB ($\Delta T = 5^{\circ}\text{C}$)

Flow Rate		Outdoor Temperature ($^{\circ}\text{C}$)													
327 LPM		-15		-10		-5		0		5		10		15	
		Capacity (W)	Power Input (W)	Capacity (W)	Power Input (W)	Capacity (W)	Power Input (W)	Capacity (W)	Power Input (W)	Capacity (W)	Power Input (W)	Capacity (W)	Power Input (W)	Capacity (W)	Power Input (W)
Outlet Water Temp. ($^{\circ}\text{C}$)	-10	86,240	21,462	86,240	21,497	86,240	21,635	86,240	21,764	86,240	22,041	86,240	23,748	83,039	25,936
	-5	103,230	22,752	103,230	22,788	103,230	22,935	103,230	23,071	103,230	23,365	103,230	25,175	103,230	28,662
	0	114,000	21,859	114,000	21,894	114,000	22,035	114,000	22,166	114,000	22,448	114,000	24,187	114,000	27,537
	5	114,000	17,122	114,000	17,151	114,000	17,261	114,000	17,364	114,000	17,587	114,000	18,958	114,000	21,601
	7	114,000	15,955	114,000	15,984	114,000	16,087	114,000	16,184	114,000	16,395	114,000	17,689	114,000	20,192
	9	114,000	15,854	114,000	15,879	114,000	15,981	114,000	16,075	114,000	16,276	114,000	17,515	114,000	19,895
	11	114,000	15,750	114,000	15,775	114,000	15,877	114,000	15,967	114,000	16,160	114,000	17,344	114,000	19,607
	13	114,000	15,547	114,000	15,572	114,000	15,673	114,000	15,759	114,000	15,945	114,000	17,085	114,000	19,254
	15	114,000	15,349	114,000	15,374	114,000	15,473	114,000	15,557	114,000	15,735	114,000	16,831	114,000	18,908
	20	114,000	15,175	114,000	15,199	114,000	15,297	114,000	15,374	114,000	15,534	114,000	16,520	114,000	18,368

Flow Rate		Outdoor Temperature ($^{\circ}\text{C}$)													
327 LPM		20		25		30		35		40		45		48	
		Capacity (W)	Power Input (W)	Capacity (W)	Power Input (W)	Capacity (W)	Power Input (W)	Capacity (W)	Power Input (W)	Capacity (W)	Power Input (W)	Capacity (W)	Power Input (W)	Capacity (W)	Power Input (W)
Outlet Water Temp. ($^{\circ}\text{C}$)	-10	77,525	28,129	75,891	31,943	75,891	36,425	74,263	41,699	66,880	43,439	58,672	43,439	47,845	37,785
	-5	102,327	33,061	100,254	37,978	100,254	43,306	85,956	43,439	74,311	43,439	65,191	43,439	61,114	43,439
	0	114,000	31,906	114,000	36,970	114,000	42,157	99,167	43,439	84,747	43,439	72,434	43,439	67,904	43,439
	5	114,000	25,054	114,000	29,065	114,000	33,184	114,000	38,891	109,835	43,439	90,323	43,439	84,681	43,439
	7	114,000	23,475	114,000	27,306	114,000	31,258	114,000	35,574	114,000	42,797	94,253	43,439	88,398	43,439
	9	114,000	22,983	114,000	26,541	114,000	30,163	114,000	35,120	114,000	40,447	101,742	43,439	94,354	42,823
	11	114,000	22,513	114,000	25,819	114,000	29,142	114,000	33,608	114,000	38,342	109,310	43,439	97,822	41,521
	13	114,000	22,022	114,000	25,147	114,000	28,262	114,000	32,402	114,000	36,757	114,000	42,796	100,838	40,485
	15	114,000	21,540	114,000	24,489	114,000	27,405	114,000	31,236	114,000	35,237	114,000	40,671	102,937	39,184
	20	114,000	20,658	114,000	23,159	114,000	25,568	114,000	28,623	114,000	31,752	114,000	35,309	107,970	36,457

Air-Cooled Scroll Chiller (R410A)

4. Performance Data

■ A(C)CAH033VETB ($\Delta T = 7^{\circ}\text{C}$)

Flow Rate		Outdoor Temperature ($^{\circ}\text{C}$)													
		-15		-10		-5		0		5		10		15	
240 LPM		Capacity (W)	Power Input (W)	Capacity (W)	Power Input (W)	Capacity (W)	Power Input (W)	Capacity (W)	Power Input (W)	Capacity (W)	Power Input (W)	Capacity (W)	Power Input (W)	Capacity (W)	Power Input (W)
Outlet Water Temp. ($^{\circ}\text{C}$)	-10	88,741	21,570	88,741	21,604	88,741	21,744	88,741	21,873	88,741	22,151	88,741	23,867	85,447	26,065
	-5	106,224	22,865	106,224	22,902	106,224	23,050	106,224	23,186	106,224	23,482	106,224	25,301	106,224	28,805
	0	117,306	21,968	117,306	22,003	117,306	22,145	117,306	22,277	117,306	22,561	117,306	24,308	117,306	27,675
	5	117,306	17,208	117,306	17,236	117,306	17,348	117,306	17,451	117,306	17,675	117,306	19,052	117,306	21,709
	7	117,306	16,035	117,306	16,064	117,306	16,168	117,306	16,265	117,306	16,477	117,306	17,778	117,306	20,293
	9	117,306	15,933	117,306	15,958	117,306	16,061	117,306	16,155	117,306	16,358	117,306	17,602	117,306	19,995
	11	117,306	15,829	117,306	15,854	117,306	15,956	117,306	16,047	117,306	16,240	117,306	17,431	117,306	19,705
	13	117,306	15,625	117,306	15,650	117,306	15,751	117,306	15,838	117,306	16,025	117,306	17,170	117,306	19,351
	15	117,306	15,426	117,306	15,451	117,306	15,551	117,306	15,635	117,306	15,814	117,306	16,915	117,306	19,003
	20	117,306	15,251	117,306	15,275	117,306	15,374	117,306	15,451	117,306	15,612	117,306	16,603	117,306	18,460

Flow Rate		Outdoor Temperature ($^{\circ}\text{C}$)													
		20		25		30		35		40		45		48	
240 LPM		Capacity (W)	Power Input (W)	Capacity (W)	Power Input (W)	Capacity (W)	Power Input (W)	Capacity (W)	Power Input (W)	Capacity (W)	Power Input (W)	Capacity (W)	Power Input (W)	Capacity (W)	Power Input (W)
Outlet Water Temp. ($^{\circ}\text{C}$)	-10	79,773	28,270	78,092	32,103	78,092	36,607	76,417	41,908	68,477	43,439	60,073	43,439	49,232	37,974
	-5	105,294	33,227	103,161	38,168	102,962	43,439	88,008	43,439	76,086	43,439	66,748	43,439	62,573	43,439
	0	117,306	32,066	117,306	37,154	117,306	42,368	101,535	43,439	86,770	43,439	74,164	43,439	69,526	43,439
	5	117,306	25,180	117,306	29,211	117,306	33,350	117,306	39,085	112,458	43,439	92,480	43,439	86,704	43,439
	7	117,306	23,592	117,306	27,442	117,306	31,415	117,306	35,752	117,306	43,011	96,504	43,439	90,509	43,439
	9	117,306	23,098	117,306	26,674	117,306	30,314	117,306	35,295	117,306	40,649	104,171	43,439	97,090	43,037
	11	117,306	22,625	117,306	25,948	117,306	29,288	117,306	33,776	117,306	38,534	111,921	43,439	100,659	41,728
	13	117,306	22,132	117,306	25,272	117,306	28,403	117,306	32,564	117,306	36,940	117,306	43,010	103,762	40,687
	15	117,306	21,648	117,306	24,611	117,306	27,542	117,306	31,392	117,306	35,413	117,306	40,875	105,922	39,380
	20	117,306	20,762	117,306	23,275	117,306	25,695	117,306	28,766	117,306	31,911	117,306	35,485	111,101	36,639

Air-Cooled Scroll Chiller (R410A)

4. Performance Data

■ A(C)CAH033VETB ($\Delta T = 10^{\circ}\text{C}$)

Flow Rate		Outdoor Temperature ($^{\circ}\text{C}$)													
		-15		-10		-5		0		5		10		15	
175 LPM		Capacity (W)	Power Input (W)	Capacity (W)	Power Input (W)	Capacity (W)	Power Input (W)	Capacity (W)	Power Input (W)	Capacity (W)	Power Input (W)	Capacity (W)	Power Input (W)	Capacity (W)	Power Input (W)
Outlet Water Temp. ($^{\circ}\text{C}$)	-10	92,449	21,741	92,449	21,776	92,449	21,917	92,449	22,047	92,449	22,328	92,449	24,057	89,018	26,273
	-5	110,663	23,047	110,663	23,084	110,663	23,233	110,663	23,371	110,663	23,669	110,663	25,502	110,663	29,034
	0	122,208	22,143	122,208	22,179	122,208	22,322	122,208	22,454	122,208	22,740	122,208	24,502	122,208	27,895
	5	122,208	17,345	122,208	17,374	122,208	17,486	122,208	17,590	122,208	17,816	122,208	19,204	122,208	21,882
	7	122,208	16,162	122,208	16,192	122,208	16,296	122,208	16,395	122,208	16,608	122,208	17,919	122,208	20,455
	9	122,208	16,060	122,208	16,085	122,208	16,189	122,208	16,284	122,208	16,488	122,208	17,743	122,208	20,154
	11	122,208	15,955	122,208	15,980	122,208	16,083	122,208	16,175	122,208	16,370	122,208	17,569	122,208	19,862
	13	122,208	15,749	122,208	15,775	122,208	15,876	122,208	15,964	122,208	16,152	122,208	17,307	122,208	19,505
	15	122,208	15,549	122,208	15,574	122,208	15,674	122,208	15,759	122,208	15,940	122,208	17,049	122,208	19,154
	20	122,208	15,372	122,208	15,397	122,208	15,496	122,208	15,574	122,208	15,736	122,208	16,735	122,208	18,607

Flow Rate		Outdoor Temperature ($^{\circ}\text{C}$)													
		20		25		30		35		40		45		48	
175 LPM		Capacity (W)	Power Input (W)	Capacity (W)	Power Input (W)	Capacity (W)	Power Input (W)	Capacity (W)	Power Input (W)	Capacity (W)	Power Input (W)	Capacity (W)	Power Input (W)	Capacity (W)	Power Input (W)
Outlet Water Temp. ($^{\circ}\text{C}$)	-10	83,107	28,495	81,355	32,358	81,355	36,898	79,610	42,242	70,775	43,439	62,089	43,439	51,289	38,277
	-5	109,694	33,491	107,472	38,471	106,417	43,439	90,962	43,439	78,639	43,439	68,988	43,439	64,673	43,439
	0	122,208	32,321	122,208	37,450	122,208	42,705	104,943	43,439	89,683	43,439	76,653	43,439	71,859	43,439
	5	122,208	25,380	122,208	29,443	122,208	33,616	122,208	39,396	116,232	43,439	95,583	43,439	89,613	43,439
	7	122,208	23,780	122,208	27,661	122,208	31,665	122,208	36,037	122,208	43,354	99,742	43,439	93,546	43,439
	9	122,208	23,282	122,208	26,886	122,208	30,555	122,208	35,576	122,208	40,973	107,667	43,439	101,147	43,380
	11	122,208	22,805	122,208	26,155	122,208	29,521	122,208	34,045	122,208	38,841	115,677	43,439	104,865	42,060
	13	122,208	22,308	122,208	25,474	122,208	28,629	122,208	32,823	122,208	37,234	122,208	43,353	108,098	41,011
	15	122,208	21,820	122,208	24,807	122,208	27,761	122,208	31,642	122,208	35,695	122,208	41,200	110,348	39,693
	20	122,208	20,927	122,208	23,460	122,208	25,900	122,208	28,995	122,208	32,165	122,208	35,768	115,744	36,931

Air-Cooled Scroll Chiller (R410A)

4. Performance Data

■ A(C)CAH040VETB ($\Delta T = 5^{\circ}\text{C}$)

Flow Rate		Outdoor Temperature ($^{\circ}\text{C}$)													
372 LPM		-15		-10		-5		0		5		10		15	
		Capacity (W)	Power Input (W)	Capacity (W)	Power Input (W)	Capacity (W)	Power Input (W)	Capacity (W)	Power Input (W)	Capacity (W)	Power Input (W)	Capacity (W)	Power Input (W)	Capacity (W)	Power Input (W)
Outlet Water Temp. ($^{\circ}\text{C}$)	-10	88,000	21,296	88,000	21,330	88,000	21,468	88,000	21,595	88,000	21,871	88,000	23,565	84,733	25,735
	-5	104,328	22,723	104,328	22,759	104,328	22,906	104,328	23,042	104,328	23,336	104,328	25,143	104,328	28,626
	0	122,220	23,958	122,220	23,996	122,220	24,151	122,220	24,294	122,220	24,604	122,220	26,510	122,220	30,182
	5	130,000	20,207	130,000	20,241	130,000	20,372	130,000	20,493	130,000	20,756	130,000	22,373	130,000	25,493
	7	130,000	18,830	130,000	18,864	130,000	18,986	130,000	19,101	130,000	19,349	130,000	20,877	130,000	23,831
	9	130,000	18,710	130,000	18,740	130,000	18,861	130,000	18,971	130,000	19,209	130,000	20,671	130,000	23,480
	11	130,000	18,588	130,000	18,618	130,000	18,738	130,000	18,844	130,000	19,071	130,000	20,469	130,000	23,140
	13	130,000	18,349	130,000	18,378	130,000	18,497	130,000	18,599	130,000	18,818	130,000	20,163	130,000	22,724
	15	130,000	18,115	130,000	18,144	130,000	18,261	130,000	18,360	130,000	18,570	130,000	19,863	130,000	22,315
	20	130,000	17,909	130,000	17,938	130,000	18,053	130,000	18,144	130,000	18,333	130,000	19,497	130,000	21,678

Flow Rate		Outdoor Temperature ($^{\circ}\text{C}$)													
372 LPM		20		25		30		35		40		45		48	
		Capacity (W)	Power Input (W)	Capacity (W)	Power Input (W)	Capacity (W)	Power Input (W)	Capacity (W)	Power Input (W)	Capacity (W)	Power Input (W)	Capacity (W)	Power Input (W)	Capacity (W)	Power Input (W)
Outlet Water Temp. ($^{\circ}\text{C}$)	-10	79,106	27,912	77,440	31,696	77,440	36,144	75,778	41,376	73,572	46,468	62,522	45,932	48,328	37,872
	-5	103,378	32,828	101,200	37,278	101,200	42,510	99,028	48,664	91,702	52,126	78,838	52,126	63,156	44,542
	0	122,220	34,970	122,220	40,520	122,220	46,204	116,012	51,310	101,891	52,126	87,598	52,126	73,986	46,964
	5	130,000	29,568	130,000	34,302	130,000	39,164	130,000	45,898	127,352	52,126	109,233	52,126	86,908	44,236
	7	130,000	27,704	130,000	32,226	130,000	36,890	130,000	43,400	130,000	50,508	113,986	52,126	91,804	44,764
	9	130,000	27,124	130,000	31,324	130,000	35,598	130,000	41,448	130,000	47,736	118,502	50,202	95,306	42,920
	11	130,000	26,570	130,000	30,472	130,000	34,394	130,000	39,664	130,000	45,252	121,000	48,294	98,810	41,616
	13	130,000	25,990	130,000	29,678	130,000	33,354	130,000	38,240	130,000	43,380	123,174	46,786	101,856	40,578
	15	130,000	25,422	130,000	28,902	130,000	32,342	130,000	36,864	130,000	41,586	123,500	44,640	103,976	39,274
	20	130,000	24,380	130,000	27,332	130,000	30,174	130,000	33,780	130,000	37,474	123,500	38,754	109,060	36,540

Air-Cooled Scroll Chiller (R410A)

4. Performance Data

■ A(C)CAH040VETB ($\Delta T = 7^{\circ}\text{C}$)

Flow Rate		Outdoor Temperature ($^{\circ}\text{C}$)													
		-15		-10		-5		0		5		10		15	
372 LPM		Capacity (W)	Power Input (W)	Capacity (W)	Power Input (W)	Capacity (W)	Power Input (W)	Capacity (W)	Power Input (W)	Capacity (W)	Power Input (W)	Capacity (W)	Power Input (W)	Capacity (W)	Power Input (W)
Outlet Water Temp. ($^{\circ}\text{C}$)	-10	90,552	21,403	90,552	21,437	90,552	21,575	90,552	21,703	90,552	21,980	90,552	23,682	87,191	25,864
	-5	107,354	22,837	107,354	22,873	107,354	23,021	107,354	23,157	107,354	23,452	107,354	25,269	107,354	28,769
	0	125,764	24,078	125,764	24,116	125,764	24,272	125,764	24,416	125,764	24,727	125,764	26,642	125,764	30,332
	5	133,770	20,308	133,770	20,342	133,770	20,474	133,770	20,596	133,770	20,860	133,770	22,485	133,770	25,621
	7	133,770	18,924	133,770	18,958	133,770	19,081	133,770	19,196	133,770	19,445	133,770	20,981	133,770	23,950
	9	133,770	18,804	133,770	18,834	133,770	18,955	133,770	19,066	133,770	19,305	133,770	20,774	133,770	23,597
	11	133,770	18,681	133,770	18,711	133,770	18,832	133,770	18,938	133,770	19,167	133,770	20,571	133,770	23,255
	13	133,770	18,440	133,770	18,470	133,770	18,589	133,770	18,692	133,770	18,912	133,770	20,264	133,770	22,837
	15	133,770	18,206	133,770	18,235	133,770	18,352	133,770	18,452	133,770	18,663	133,770	19,963	133,770	22,427
	20	133,770	17,999	133,770	18,027	133,770	18,144	133,770	18,235	133,770	18,425	133,770	19,595	133,770	21,787

Flow Rate		Outdoor Temperature ($^{\circ}\text{C}$)													
		20		25		30		35		40		45		48	
372 LPM		Capacity (W)	Power Input (W)	Capacity (W)	Power Input (W)	Capacity (W)	Power Input (W)	Capacity (W)	Power Input (W)	Capacity (W)	Power Input (W)	Capacity (W)	Power Input (W)	Capacity (W)	Power Input (W)
Outlet Water Temp. ($^{\circ}\text{C}$)	-10	81,401	28,051	79,686	31,854	79,686	36,324	77,976	41,584	75,706	46,699	64,335	46,161	49,729	38,061
	-5	106,376	32,992	104,135	37,465	104,135	42,722	101,901	48,908	93,892	52,126	80,721	52,126	64,987	44,765
	0	125,764	35,145	125,764	40,722	125,764	46,436	119,376	51,566	104,325	52,126	89,690	52,126	76,132	47,198
	5	133,770	29,717	133,770	34,474	133,770	39,359	133,770	46,128	130,394	52,126	111,840	52,126	89,427	44,457
	7	133,770	27,843	133,770	32,387	133,770	37,075	133,770	43,517	133,770	50,761	116,707	52,126	94,466	44,987
	9	133,770	27,260	133,770	31,480	133,770	35,776	133,770	41,655	133,770	47,974	121,938	50,454	98,071	43,136
	11	133,770	26,702	133,770	30,624	133,770	34,565	133,770	39,862	133,770	45,477	124,510	48,536	101,676	41,824
	13	133,770	26,120	133,770	29,826	133,770	33,521	133,770	38,431	133,770	43,597	126,746	47,020	104,810	40,780
	15	133,770	25,549	133,770	29,046	133,770	32,504	133,770	37,048	133,770	41,794	127,082	44,863	106,992	39,470
	20	133,770	24,503	133,770	27,469	133,770	30,325	133,770	33,949	133,770	37,660	127,082	38,947	112,223	36,723

Air-Cooled Scroll Chiller (R410A)

4. Performance Data

■ A(C)CAH040VETB ($\Delta T = 10^{\circ}\text{C}$)

Flow Rate		Outdoor Temperature ($^{\circ}\text{C}$)													
		-15		-10		-5		0		5		10		15	
200 LPM		Capacity (W)	Power Input (W)	Capacity (W)	Power Input (W)	Capacity (W)	Power Input (W)	Capacity (W)	Power Input (W)	Capacity (W)	Power Input (W)	Capacity (W)	Power Input (W)	Capacity (W)	Power Input (W)
Outlet Water Temp. ($^{\circ}\text{C}$)	-10	94,336	21,573	94,336	21,608	94,336	21,747	94,336	21,876	94,336	22,155	94,336	23,871	90,834	26,070
	-5	111,840	23,018	111,840	23,055	111,840	23,204	111,840	23,342	111,840	23,639	111,840	25,470	111,840	28,998
	0	131,020	24,269	131,020	24,308	131,020	24,465	131,020	24,610	131,020	24,924	131,020	26,854	131,020	30,574
	5	139,360	20,470	139,360	20,504	139,360	20,637	139,360	20,760	139,360	21,026	139,360	22,664	139,360	25,825
	7	139,360	19,074	139,360	19,109	139,360	19,233	139,360	19,349	139,360	19,600	139,360	21,148	139,360	24,140
	9	139,360	18,953	139,360	18,984	139,360	19,106	139,360	19,218	139,360	19,459	139,360	20,940	139,360	23,785
	11	139,360	18,830	139,360	18,860	139,360	18,981	139,360	19,089	139,360	19,319	139,360	20,735	139,360	23,441
	13	139,360	18,587	139,360	18,617	139,360	18,737	139,360	18,841	139,360	19,062	139,360	20,425	139,360	23,019
	15	139,360	18,351	139,360	18,380	139,360	18,499	139,360	18,599	139,360	18,812	139,360	20,122	139,360	22,605
	20	139,360	18,142	139,360	18,171	139,360	18,288	139,360	18,380	139,360	18,571	139,360	19,751	139,360	21,960

Flow Rate		Outdoor Temperature ($^{\circ}\text{C}$)													
		20		25		30		35		40		45		48	
200 LPM		Capacity (W)	Power Input (W)	Capacity (W)	Power Input (W)	Capacity (W)	Power Input (W)	Capacity (W)	Power Input (W)	Capacity (W)	Power Input (W)	Capacity (W)	Power Input (W)	Capacity (W)	Power Input (W)
Outlet Water Temp. ($^{\circ}\text{C}$)	-10	84,803	28,275	83,016	32,108	83,016	36,613	81,235	41,915	78,869	47,071	67,024	46,528	51,807	38,364
	-5	110,822	33,255	108,486	37,763	108,486	43,062	106,159	49,298	97,043	52,126	83,430	52,126	67,703	45,122
	0	131,020	35,425	131,020	41,046	131,020	46,806	124,365	51,977	107,826	52,126	92,701	52,126	79,314	47,574
	5	139,360	29,953	139,360	34,749	139,360	39,673	139,360	46,495	134,770	52,126	115,594	52,126	93,164	44,810
	7	139,360	28,065	139,360	32,645	139,360	37,370	139,360	43,863	139,360	51,165	120,623	52,126	98,413	45,345
	9	139,360	27,477	139,360	31,731	139,360	36,061	139,360	41,987	139,360	48,356	127,033	50,855	102,169	43,479
	11	139,360	26,914	139,360	30,868	139,360	34,840	139,360	40,179	139,360	45,839	129,713	48,922	105,924	42,157
	13	139,360	26,328	139,360	30,064	139,360	33,788	139,360	38,737	139,360	43,944	132,043	47,394	109,190	41,105
	15	139,360	25,752	139,360	29,277	139,360	32,763	139,360	37,343	139,360	42,126	132,392	45,220	111,463	39,784
	20	139,360	24,698	139,360	27,688	139,360	30,567	139,360	34,220	139,360	37,960	132,392	39,257	116,913	37,016

Air-Cooled Scroll Chiller (R410A)

4. Performance Data

■ A(C)CAH050VETB ($\Delta T = 5^{\circ}\text{C}$)

Flow Rate		Outdoor Temperature ($^{\circ}\text{C}$)													
491 LPM		-15		-10		-5		0		5		10		15	
		Capacity (W)	Power Input (W)	Capacity (W)	Power Input (W)	Capacity (W)	Power Input (W)	Capacity (W)	Power Input (W)	Capacity (W)	Power Input (W)	Capacity (W)	Power Input (W)	Capacity (W)	Power Input (W)
Outlet Water Temp. ($^{\circ}\text{C}$)	-10	129,360	32,194	129,360	32,245	129,360	32,453	129,360	32,646	129,360	33,062	129,360	35,622	124,558	38,904
	-5	154,845	34,127	154,845	34,182	154,845	34,403	154,845	34,607	154,845	35,048	154,845	37,762	154,845	42,993
	0	171,000	32,788	171,000	32,841	171,000	33,053	171,000	33,249	171,000	33,673	171,000	36,281	171,000	41,306
	5	171,000	25,683	171,000	25,726	171,000	25,892	171,000	26,047	171,000	26,381	171,000	28,436	171,000	32,401
	7	171,000	23,932	171,000	23,976	171,000	24,131	171,000	24,277	171,000	24,592	171,000	26,534	171,000	30,288
	9	171,000	23,780	171,000	23,819	171,000	23,972	171,000	24,112	171,000	24,414	171,000	26,272	171,000	29,843
	11	171,000	23,625	171,000	23,663	171,000	23,816	171,000	23,950	171,000	24,239	171,000	26,016	171,000	29,410
	13	171,000	23,321	171,000	23,358	171,000	23,509	171,000	23,639	171,000	23,917	171,000	25,627	171,000	28,881
	15	171,000	23,024	171,000	23,061	171,000	23,210	171,000	23,336	171,000	23,603	171,000	25,246	171,000	28,362
	20	171,000	22,762	171,000	22,799	171,000	22,946	171,000	23,061	171,000	23,301	171,000	24,780	171,000	27,553

Flow Rate		Outdoor Temperature ($^{\circ}\text{C}$)													
491 LPM		20		25		30		35		40		45		48	
		Capacity (W)	Power Input (W)	Capacity (W)	Power Input (W)	Capacity (W)	Power Input (W)	Capacity (W)	Power Input (W)	Capacity (W)	Power Input (W)	Capacity (W)	Power Input (W)	Capacity (W)	Power Input (W)
Outlet Water Temp. ($^{\circ}\text{C}$)	-10	116,287	42,194	113,837	47,914	113,837	54,637	111,394	62,549	100,320	65,158	88,008	65,158	71,767	56,678
	-5	153,490	49,592	150,381	56,966	150,381	64,959	128,934	65,158	111,467	65,158	97,787	65,158	91,671	65,158
	0	171,000	47,859	171,000	55,454	171,000	63,235	148,750	65,158	127,120	65,158	108,652	65,158	101,857	65,158
	5	171,000	37,582	171,000	43,598	171,000	49,776	171,000	58,336	164,753	65,158	135,484	65,158	127,022	65,158
	7	171,000	35,213	171,000	40,958	171,000	46,888	171,000	53,361	171,000	64,196	141,379	65,158	132,597	65,158
	9	171,000	34,475	171,000	39,812	171,000	45,245	171,000	52,680	171,000	60,671	152,613	65,158	141,530	64,235
	11	171,000	33,769	171,000	38,729	171,000	43,714	171,000	50,412	171,000	57,514	163,966	65,158	146,733	62,281
	13	171,000	33,033	171,000	37,720	171,000	42,393	171,000	48,603	171,000	55,135	171,000	64,194	151,257	60,727
	15	171,000	32,310	171,000	36,734	171,000	41,107	171,000	46,854	171,000	52,855	171,000	61,007	154,405	58,775
	20	171,000	30,988	171,000	34,739	171,000	38,351	171,000	42,935	171,000	47,628	171,000	52,963	161,955	54,686

Air-Cooled Scroll Chiller (R410A)

4. Performance Data

■ A(C)CAH050VETB ($\Delta T = 7^{\circ}\text{C}$)

Flow Rate		Outdoor Temperature ($^{\circ}\text{C}$)													
		-15		-10		-5		0		5		10		15	
360 LPM		Capacity (W)	Power Input (W)	Capacity (W)	Power Input (W)	Capacity (W)	Power Input (W)	Capacity (W)	Power Input (W)	Capacity (W)	Power Input (W)	Capacity (W)	Power Input (W)	Capacity (W)	Power Input (W)
Outlet Water Temp. ($^{\circ}\text{C}$)	-10	133,111	32,355	133,111	32,406	133,111	32,615	133,111	32,809	133,111	33,227	133,111	35,801	128,170	39,098
	-5	159,336	34,298	159,336	34,353	159,336	34,575	159,336	34,780	159,336	35,223	159,336	37,951	159,336	43,208
	0	175,959	32,952	175,959	33,005	175,959	33,218	175,959	33,415	175,959	33,841	175,959	36,462	175,959	41,513
	5	175,959	25,812	175,959	25,855	175,959	26,022	175,959	26,177	175,959	26,512	175,959	28,578	175,959	32,563
	7	175,959	24,052	175,959	24,096	175,959	24,252	175,959	24,398	175,959	24,715	175,959	26,667	175,959	30,440
	9	175,959	23,899	175,959	23,938	175,959	24,092	175,959	24,233	175,959	24,536	175,959	26,404	175,959	29,992
	11	175,959	23,743	175,959	23,781	175,959	23,935	175,959	24,070	175,959	24,361	175,959	26,146	175,959	29,557
	13	175,959	23,437	175,959	23,475	175,959	23,626	175,959	23,757	175,959	24,037	175,959	25,755	175,959	29,026
	15	175,959	23,139	175,959	23,176	175,959	23,326	175,959	23,452	175,959	23,721	175,959	25,372	175,959	28,504
	20	175,959	22,876	175,959	22,913	175,959	23,060	175,959	23,176	175,959	23,417	175,959	24,904	175,959	27,691

Flow Rate		Outdoor Temperature ($^{\circ}\text{C}$)													
		20		25		30		35		40		45		48	
360 LPM		Capacity (W)	Power Input (W)	Capacity (W)	Power Input (W)	Capacity (W)	Power Input (W)	Capacity (W)	Power Input (W)	Capacity (W)	Power Input (W)	Capacity (W)	Power Input (W)	Capacity (W)	Power Input (W)
Outlet Water Temp. ($^{\circ}\text{C}$)	-10	119,660	42,405	117,138	48,154	117,138	54,911	114,625	62,862	102,716	65,158	90,110	65,158	73,848	56,962
	-5	157,941	49,840	154,742	57,251	154,442	65,158	132,013	65,158	114,129	65,158	100,122	65,158	93,860	65,158
	0	175,959	48,099	175,959	55,732	175,959	63,551	152,303	65,158	130,156	65,158	111,246	65,158	104,289	65,158
	5	175,959	37,770	175,959	43,816	175,959	50,025	175,959	58,627	168,687	65,158	138,719	65,158	130,055	65,158
	7	175,959	35,389	175,959	41,163	175,959	47,122	175,959	53,628	175,959	64,517	144,756	65,158	135,763	65,158
	9	175,959	34,648	175,959	40,011	175,959	45,471	175,959	52,943	175,959	60,974	156,257	65,158	145,635	64,556
	11	175,959	33,938	175,959	38,922	175,959	43,932	175,959	50,664	175,959	57,801	167,881	65,158	150,988	62,592
	13	175,959	33,198	175,959	37,909	175,959	42,605	175,959	48,846	175,959	55,411	175,959	64,515	155,643	61,030
	15	175,959	32,472	175,959	36,917	175,959	41,312	175,959	47,088	175,959	53,119	175,959	61,312	158,883	59,069
	20	175,959	31,143	175,959	34,913	175,959	38,543	175,959	43,149	175,959	47,866	175,959	53,228	166,652	54,959

Air-Cooled Scroll Chiller (R410A)

4. Performance Data

■ A(C)CAH050VETB ($\Delta T = 10^{\circ}\text{C}$)

Flow Rate		Outdoor Temperature ($^{\circ}\text{C}$)													
		-15		-10		-5		0		5		10		15	
263 LPM		Capacity (W)	Power Input (W)	Capacity (W)	Power Input (W)	Capacity (W)	Power Input (W)	Capacity (W)	Power Input (W)	Capacity (W)	Power Input (W)	Capacity (W)	Power Input (W)	Capacity (W)	Power Input (W)
Outlet Water Temp. ($^{\circ}\text{C}$)	-10	138,674	32,612	138,674	32,664	138,674	32,875	138,674	33,070	138,674	33,492	138,674	36,086	133,526	39,409
	-5	165,994	34,571	165,994	34,626	165,994	34,850	165,994	35,057	165,994	35,503	165,994	38,253	165,994	43,552
	0	183,312	33,215	183,312	33,268	183,312	33,482	183,312	33,681	183,312	34,110	183,312	36,752	183,312	41,843
	5	183,312	26,017	183,312	26,060	183,312	26,229	183,312	26,385	183,312	26,724	183,312	28,806	183,312	32,823
	7	183,312	24,243	183,312	24,287	183,312	24,445	183,312	24,592	183,312	24,912	183,312	26,879	183,312	30,682
	9	183,312	24,090	183,312	24,128	183,312	24,284	183,312	24,426	183,312	24,732	183,312	26,614	183,312	30,231
	11	183,312	23,932	183,312	23,971	183,312	24,125	183,312	24,262	183,312	24,554	183,312	26,354	183,312	29,793
	13	183,312	23,624	183,312	23,662	183,312	23,814	183,312	23,946	183,312	24,228	183,312	25,960	183,312	29,257
	15	183,312	23,323	183,312	23,361	183,312	23,511	183,312	23,639	183,312	23,910	183,312	25,574	183,312	28,731
	20	183,312	23,058	183,312	23,095	183,312	23,244	183,312	23,360	183,312	23,604	183,312	25,103	183,312	27,911

Flow Rate		Outdoor Temperature ($^{\circ}\text{C}$)													
		20		25		30		35		40		45		48	
263 LPM		Capacity (W)	Power Input (W)	Capacity (W)	Power Input (W)	Capacity (W)	Power Input (W)	Capacity (W)	Power Input (W)	Capacity (W)	Power Input (W)	Capacity (W)	Power Input (W)	Capacity (W)	Power Input (W)
Outlet Water Temp. ($^{\circ}\text{C}$)	-10	124,660	42,742	122,033	48,537	122,033	55,348	119,415	63,362	106,163	65,158	93,134	65,158	76,934	57,415
	-5	164,541	50,237	161,208	57,707	159,626	65,158	136,443	65,158	117,959	65,158	103,482	65,158	97,010	65,158
	0	183,312	48,482	183,312	56,175	183,312	64,057	157,414	65,158	134,524	65,158	114,980	65,158	107,789	65,158
	5	183,312	38,070	183,312	44,165	183,312	50,423	183,312	59,094	174,348	65,158	143,375	65,158	134,420	65,158
	7	183,312	35,670	183,312	41,491	183,312	47,497	183,312	54,055	183,312	65,031	149,614	65,158	140,319	65,158
	9	183,312	34,923	183,312	40,329	183,312	45,833	183,312	53,364	183,312	61,459	161,501	65,158	151,721	65,070
	11	183,312	34,208	183,312	39,232	183,312	44,282	183,312	51,067	183,312	58,261	173,516	65,158	157,298	63,091
	13	183,312	33,462	183,312	38,210	183,312	42,944	183,312	49,234	183,312	55,852	183,312	65,029	162,148	61,516
	15	183,312	32,730	183,312	37,211	183,312	41,641	183,312	47,463	183,312	53,542	183,312	61,800	165,522	59,540
	20	183,312	31,391	183,312	35,191	183,312	38,850	183,312	43,493	183,312	48,247	183,312	53,651	173,616	55,397

Air-Cooled Scroll Chiller (R410A)

4. Performance Data

■ A(C)CAH060VETB ($\Delta T = 5^{\circ}\text{C}$)

Flow Rate		Outdoor Temperature ($^{\circ}\text{C}$)													
		-15		-10		-5		0		5		10		15	
558 LPM		Capacity (W)	Power Input (W)	Capacity (W)	Power Input (W)	Capacity (W)	Power Input (W)	Capacity (W)	Power Input (W)	Capacity (W)	Power Input (W)	Capacity (W)	Power Input (W)	Capacity (W)	Power Input (W)
Outlet Water Temp. ($^{\circ}\text{C}$)	-10	132,000	31,945	132,000	31,996	132,000	32,202	132,000	32,393	132,000	32,806	132,000	35,347	127,100	38,603
	-5	156,492	34,085	156,492	34,139	156,492	34,359	156,492	34,563	156,492	35,004	156,492	37,715	156,492	42,939
	0	183,330	35,937	183,330	35,995	183,330	36,227	183,330	36,442	183,330	36,906	183,330	39,764	183,330	45,272
	5	195,000	30,311	195,000	30,362	195,000	30,558	195,000	30,740	195,000	31,134	195,000	33,560	195,000	38,240
	7	195,000	28,244	195,000	28,296	195,000	28,479	195,000	28,651	195,000	29,023	195,000	31,315	195,000	35,746
	9	195,000	28,065	195,000	28,110	195,000	28,292	195,000	28,457	195,000	28,813	195,000	31,006	195,000	35,220
	11	195,000	27,882	195,000	27,927	195,000	28,107	195,000	28,266	195,000	28,607	195,000	30,704	195,000	34,710
	13	195,000	27,523	195,000	27,567	195,000	27,745	195,000	27,899	195,000	28,227	195,000	30,244	195,000	34,085
	15	195,000	27,173	195,000	27,216	195,000	27,392	195,000	27,540	195,000	27,856	195,000	29,795	195,000	33,473
	20	195,000	26,864	195,000	26,907	195,000	27,080	195,000	27,216	195,000	27,499	195,000	29,246	195,000	32,517

Flow Rate		Outdoor Temperature ($^{\circ}\text{C}$)													
		20		25		30		35		40		45		48	
558 LPM		Capacity (W)	Power Input (W)	Capacity (W)	Power Input (W)	Capacity (W)	Power Input (W)	Capacity (W)	Power Input (W)	Capacity (W)	Power Input (W)	Capacity (W)	Power Input (W)	Capacity (W)	Power Input (W)
Outlet Water Temp. ($^{\circ}\text{C}$)	-10	118,659	41,868	116,160	47,544	116,160	54,216	113,667	62,064	110,358	69,702	93,783	68,898	72,492	56,808
	-5	155,067	49,242	151,800	55,917	151,800	63,765	148,542	72,996	137,553	78,189	118,258	78,189	94,734	66,813
	0	183,330	52,455	183,330	60,780	183,330	69,306	174,018	76,965	152,836	78,189	131,397	78,189	110,979	70,446
	5	195,000	44,352	195,000	51,453	195,000	58,746	195,000	68,847	191,027	78,189	163,849	78,189	130,362	66,354
	7	195,000	41,556	195,000	48,339	195,000	55,335	195,000	65,100	195,000	75,762	170,979	78,189	137,706	67,146
	9	195,000	40,686	195,000	46,986	195,000	53,397	195,000	62,172	195,000	71,604	177,753	75,303	142,959	64,380
	11	195,000	39,855	195,000	45,708	195,000	51,591	195,000	59,496	195,000	67,878	181,500	72,441	148,215	62,424
	13	195,000	38,985	195,000	44,517	195,000	50,031	195,000	57,360	195,000	65,070	184,761	70,179	152,784	60,867
	15	195,000	38,133	195,000	43,353	195,000	48,513	195,000	55,296	195,000	62,379	185,250	66,960	155,964	58,911
	20	195,000	36,570	195,000	40,998	195,000	45,261	195,000	50,670	195,000	56,211	185,250	58,131	163,590	54,810

Air-Cooled Scroll Chiller (R410A)

4. Performance Data

■ A(C)CAH060VETB ($\Delta T = 7^{\circ}\text{C}$)

Flow Rate		Outdoor Temperature ($^{\circ}\text{C}$)													
		-15		-10		-5		0		5		10		15	
411 LPM		Capacity (W)	Power Input (W)	Capacity (W)	Power Input (W)	Capacity (W)	Power Input (W)	Capacity (W)	Power Input (W)	Capacity (W)	Power Input (W)	Capacity (W)	Power Input (W)	Capacity (W)	Power Input (W)
Outlet Water Temp. ($^{\circ}\text{C}$)	-10	135,828	32,104	135,828	32,156	135,828	32,363	135,828	32,555	135,828	32,970	135,828	35,524	130,786	38,796
	-5	161,030	34,255	161,030	34,310	161,030	34,531	161,030	34,736	161,030	35,179	161,030	37,903	161,030	43,153
	0	188,647	36,117	188,647	36,175	188,647	36,408	188,647	36,624	188,647	37,091	188,647	39,963	188,647	45,499
	5	200,655	30,462	200,655	30,513	200,655	30,710	200,655	30,894	200,655	31,290	200,655	33,728	200,655	38,431
	7	200,655	28,386	200,655	28,437	200,655	28,621	200,655	28,794	200,655	29,168	200,655	31,472	200,655	35,925
	9	200,655	28,206	200,655	28,251	200,655	28,433	200,655	28,599	200,655	28,958	200,655	31,161	200,655	35,396
	11	200,655	28,021	200,655	28,066	200,655	28,247	200,655	28,407	200,655	28,750	200,655	30,857	200,655	34,883
	13	200,655	27,660	200,655	27,705	200,655	27,883	200,655	28,038	200,655	28,368	200,655	30,396	200,655	34,256
	15	200,655	27,309	200,655	27,352	200,655	27,529	200,655	27,678	200,655	27,995	200,655	29,944	200,655	33,640
	20	200,655	26,998	200,655	27,041	200,655	27,216	200,655	27,352	200,655	27,637	200,655	29,392	200,655	32,680

Flow Rate		Outdoor Temperature ($^{\circ}\text{C}$)													
		20		25		30		35		40		45		48	
411 LPM		Capacity (W)	Power Input (W)	Capacity (W)	Power Input (W)	Capacity (W)	Power Input (W)	Capacity (W)	Power Input (W)	Capacity (W)	Power Input (W)	Capacity (W)	Power Input (W)	Capacity (W)	Power Input (W)
Outlet Water Temp. ($^{\circ}\text{C}$)	-10	122,102	42,077	119,529	47,781	119,529	54,486	116,964	62,376	113,559	70,049	96,503	69,241	74,594	57,092
	-5	159,565	49,488	156,202	56,198	156,202	64,083	152,851	73,362	140,838	78,189	121,082	78,189	97,481	67,148
	0	188,647	52,717	188,647	61,083	188,647	69,654	179,065	77,349	156,487	78,189	134,536	78,189	114,199	70,797
	5	200,655	44,575	200,655	51,711	200,655	59,039	200,655	69,191	195,591	78,189	167,760	78,189	134,141	66,685
	7	200,655	41,765	200,655	48,580	200,655	55,613	200,655	65,275	200,655	76,142	175,060	78,189	141,698	67,480
	9	200,655	40,890	200,655	47,220	200,655	53,664	200,655	62,483	200,655	71,961	182,907	75,680	147,106	64,703
	11	200,655	40,053	200,655	45,936	200,655	51,848	200,655	59,793	200,655	68,216	186,764	72,803	152,513	62,736
	13	200,655	39,179	200,655	44,739	200,655	50,282	200,655	57,647	200,655	65,395	190,119	70,529	157,216	61,170
	15	200,655	38,323	200,655	43,569	200,655	48,756	200,655	55,572	200,655	62,690	190,622	67,294	160,488	59,204
	20	200,655	36,754	200,655	41,203	200,655	45,488	200,655	50,924	200,655	56,491	190,622	58,421	168,335	55,085

Air-Cooled Scroll Chiller (R410A)

4. Performance Data

■ A(C)CAH060VETB ($\Delta T = 10^{\circ}\text{C}$)

Flow Rate		Outdoor Temperature ($^{\circ}\text{C}$)													
		-15		-10		-5		0		5		10		15	
300 LPM		Capacity (W)	Power Input (W)	Capacity (W)	Power Input (W)	Capacity (W)	Power Input (W)	Capacity (W)	Power Input (W)	Capacity (W)	Power Input (W)	Capacity (W)	Power Input (W)	Capacity (W)	Power Input (W)
Outlet Water Temp. ($^{\circ}\text{C}$)	-10	141,504	32,360	141,504	32,412	141,504	32,621	141,504	32,814	141,504	33,232	141,504	35,806	136,251	39,105
	-5	167,759	34,528	167,759	34,583	167,759	34,806	167,759	35,013	167,759	35,459	167,759	38,205	167,759	43,497
	0	196,530	36,404	196,530	36,462	196,530	36,698	196,530	36,915	196,530	37,386	196,530	40,281	196,530	45,861
	5	209,040	30,705	209,040	30,756	209,040	30,955	209,040	31,139	209,040	31,539	209,040	33,996	209,040	38,737
	7	209,040	28,612	209,040	28,664	209,040	28,849	209,040	29,023	209,040	29,400	209,040	31,722	209,040	36,211
	9	209,040	28,430	209,040	28,476	209,040	28,659	209,040	28,827	209,040	29,188	209,040	31,409	209,040	35,678
	11	209,040	28,244	209,040	28,290	209,040	28,472	209,040	28,633	209,040	28,979	209,040	31,103	209,040	35,161
	13	209,040	27,881	209,040	27,925	209,040	28,105	209,040	28,261	209,040	28,594	209,040	30,638	209,040	34,528
	15	209,040	27,526	209,040	27,570	209,040	27,748	209,040	27,898	209,040	28,218	209,040	30,182	209,040	33,908
	20	209,040	27,213	209,040	27,256	209,040	27,432	209,040	27,570	209,040	27,857	209,040	29,626	209,040	32,940

Flow Rate		Outdoor Temperature ($^{\circ}\text{C}$)													
		20		25		30		35		40		45		48	
300 LPM		Capacity (W)	Power Input (W)	Capacity (W)	Power Input (W)	Capacity (W)	Power Input (W)	Capacity (W)	Power Input (W)	Capacity (W)	Power Input (W)	Capacity (W)	Power Input (W)	Capacity (W)	Power Input (W)
Outlet Water Temp. ($^{\circ}\text{C}$)	-10	127,204	42,412	124,524	48,162	124,524	54,919	121,852	62,872	118,304	70,607	100,536	69,792	77,711	57,546
	-5	166,233	49,882	162,730	56,645	162,730	64,593	159,238	73,946	145,565	78,189	125,146	78,189	101,554	67,682
	0	196,530	53,137	196,530	61,569	196,530	70,208	186,547	77,965	161,739	78,189	139,051	78,189	118,971	71,361
	5	209,040	44,930	209,040	52,123	209,040	59,509	209,040	69,742	202,155	78,189	173,390	78,189	139,747	67,216
	7	209,040	42,098	209,040	48,967	209,040	56,055	209,040	65,795	209,040	76,748	180,935	78,189	147,620	68,017
	9	209,040	41,216	209,040	47,596	209,040	54,092	209,040	62,980	209,040	72,534	190,550	76,283	153,253	65,218
	11	209,040	40,372	209,040	46,301	209,040	52,261	209,040	60,269	209,040	68,759	194,569	73,383	158,887	63,235
	13	209,040	39,491	209,040	45,095	209,040	50,682	209,040	58,106	209,040	65,915	198,064	71,091	163,785	61,657
	15	209,040	38,628	209,040	43,916	209,040	49,144	209,040	56,015	209,040	63,189	198,588	67,830	167,194	59,676
	20	209,040	37,047	209,040	41,531	209,040	45,850	209,040	51,330	209,040	56,940	198,588	58,886	175,370	55,523

Air-Cooled Scroll Chiller (R410A)

4. Performance Data

■ 380 - 415V

■ A(C)CAH020LETB ($\Delta T = 5^{\circ}\text{C}$)

Flow Rate		Outdoor Temperature ($^{\circ}\text{C}$)													
		-15		-10		-5		0		5		10		15	
186 LPM		Capacity (W)	Power Input (W)	Capacity (W)	Power Input (W)	Capacity (W)	Power Input (W)	Capacity (W)	Power Input (W)	Capacity (W)	Power Input (W)	Capacity (W)	Power Input (W)	Capacity (W)	Power Input (W)
Outlet Water Temp. ($^{\circ}\text{C}$)	-10	44,000	10,561	44,000	10,578	44,000	10,647	44,000	10,710	44,000	10,846	44,000	11,686	42,367	12,763
	-5	52,164	11,269	52,164	11,287	52,164	11,360	52,164	11,427	52,164	11,573	52,164	12,469	52,164	14,196
	0	61,110	11,881	61,110	11,900	61,110	11,977	61,110	12,048	61,110	12,202	61,110	13,147	61,110	14,968
	5	65,000	10,021	65,000	10,038	65,000	10,103	65,000	10,163	65,000	10,293	65,000	11,095	65,000	12,643
	7	65,000	9,338	65,000	9,355	65,000	9,416	65,000	9,472	65,000	9,595	65,000	10,353	65,000	11,818
	9	65,000	9,279	65,000	9,294	65,000	9,354	65,000	9,408	65,000	9,526	65,000	10,251	65,000	11,644
	11	65,000	9,218	65,000	9,233	65,000	9,293	65,000	9,345	65,000	9,458	65,000	10,151	65,000	11,476
	13	65,000	9,099	65,000	9,114	65,000	9,173	65,000	9,224	65,000	9,332	65,000	9,999	65,000	11,269
	15	65,000	8,984	65,000	8,998	65,000	9,056	65,000	9,105	65,000	9,210	65,000	9,851	65,000	11,067
	20	65,000	8,882	65,000	8,896	65,000	8,953	65,000	8,998	65,000	9,092	65,000	9,669	65,000	10,751

Flow Rate		Outdoor Temperature ($^{\circ}\text{C}$)													
		20		25		30		35		40		45		48	
186 LPM		Capacity (W)	Power Input (W)	Capacity (W)	Power Input (W)	Capacity (W)	Power Input (W)	Capacity (W)	Power Input (W)	Capacity (W)	Power Input (W)	Capacity (W)	Power Input (W)	Capacity (W)	Power Input (W)
Outlet Water Temp. ($^{\circ}\text{C}$)	-10	39,553	13,842	38,720	15,719	38,720	17,924	37,889	20,520	36,786	23,044	31,261	22,778	24,164	18,782
	-5	51,689	16,280	50,600	18,487	50,600	21,081	49,514	24,134	48,073	27,103	40,853	26,790	31,578	22,090
	0	61,110	17,342	61,110	20,095	61,110	22,914	58,006	25,446	56,317	28,576	47,859	28,246	36,993	23,290
	5	65,000	14,664	65,000	17,011	65,000	19,422	65,000	22,762	65,000	26,388	55,069	26,065	43,454	21,937
	7	65,000	13,740	65,000	15,981	65,000	18,295	65,000	21,500	65,000	25,049	58,001	26,308	45,902	22,199
	9	65,000	13,452	65,000	15,534	65,000	17,654	65,000	20,555	65,000	23,673	59,251	24,897	47,653	21,286
	11	65,000	13,176	65,000	15,111	65,000	17,056	65,000	19,670	65,000	22,441	60,500	23,950	49,405	20,638
	13	65,000	12,889	65,000	14,718	65,000	16,541	65,000	18,964	65,000	21,513	61,587	23,202	50,928	20,123
	15	65,000	12,607	65,000	14,333	65,000	16,039	65,000	18,282	65,000	20,623	61,750	22,138	51,988	19,477
	20	65,000	12,091	65,000	13,555	65,000	14,964	65,000	16,753	65,000	18,584	61,750	19,219	54,530	18,121

Air-Cooled Scroll Chiller (R410A)

4. Performance Data

■ A(C)CAH020LETB ($\Delta T = 7^{\circ}\text{C}$)

Flow Rate		Outdoor Temperature ($^{\circ}\text{C}$)													
137 LPM		-15		-10		-5		0		5		10		15	
		Capacity (W)	Power Input (W)	Capacity (W)	Power Input (W)	Capacity (W)	Power Input (W)	Capacity (W)	Power Input (W)	Capacity (W)	Power Input (W)	Capacity (W)	Power Input (W)	Capacity (W)	Power Input (W)
Outlet Water Temp. ($^{\circ}\text{C}$)	-10	45,276	10,614	45,276	10,631	45,276	10,700	45,276	10,763	45,276	10,900	45,276	11,745	43,595	12,826
	-5	53,677	11,325	53,677	11,343	53,677	11,417	53,677	11,484	53,677	11,631	53,677	12,531	53,677	14,267
	0	62,882	11,941	62,882	11,960	62,882	12,037	62,882	12,108	62,882	12,263	62,882	13,212	62,882	15,043
	5	66,885	10,071	66,885	10,088	66,885	10,153	66,885	10,214	66,885	10,345	66,885	11,151	66,885	12,706
	7	66,885	9,385	66,885	9,402	66,885	9,463	66,885	9,520	66,885	9,643	66,885	10,405	66,885	11,877
	9	66,885	9,325	66,885	9,340	66,885	9,400	66,885	9,455	66,885	9,574	66,885	10,302	66,885	11,702
	11	66,885	9,264	66,885	9,279	66,885	9,339	66,885	9,392	66,885	9,505	66,885	10,202	66,885	11,533
	13	66,885	9,145	66,885	9,160	66,885	9,219	66,885	9,270	66,885	9,379	66,885	10,049	66,885	11,326
	15	66,885	9,029	66,885	9,043	66,885	9,101	66,885	9,151	66,885	9,256	66,885	9,900	66,885	11,122
20	66,885	8,926	66,885	8,940	66,885	8,998	66,885	9,043	66,885	9,137	66,885	9,717	66,885	10,804	

Flow Rate		Outdoor Temperature ($^{\circ}\text{C}$)													
137 LPM		20		25		30		35		40		45		48	
		Capacity (W)	Power Input (W)	Capacity (W)	Power Input (W)	Capacity (W)	Power Input (W)	Capacity (W)	Power Input (W)	Capacity (W)	Power Input (W)	Capacity (W)	Power Input (W)	Capacity (W)	Power Input (W)
Outlet Water Temp. ($^{\circ}\text{C}$)	-10	40,701	13,911	39,843	15,797	39,843	18,014	38,988	20,622	37,853	23,159	32,168	22,892	24,865	18,875
	-5	53,188	16,362	52,067	18,580	52,067	21,187	50,950	24,255	49,467	27,239	42,037	26,924	32,494	22,200
	0	62,882	17,429	62,882	20,195	62,882	23,029	59,688	25,573	57,950	28,719	49,247	28,388	38,066	23,407
	5	66,885	14,737	66,885	17,097	66,885	19,519	66,885	22,876	66,885	26,520	56,666	26,195	44,714	22,047
	7	66,885	13,808	66,885	16,061	66,885	18,386	66,885	21,631	66,885	25,174	59,683	26,440	47,233	22,310
	9	66,885	13,519	66,885	15,612	66,885	17,742	66,885	20,658	66,885	23,791	60,969	25,021	49,035	21,392
	11	66,885	13,242	66,885	15,187	66,885	17,142	66,885	19,768	66,885	22,553	62,255	24,070	50,838	20,741
	13	66,885	12,953	66,885	14,792	66,885	16,624	66,885	19,059	66,885	21,621	63,373	23,318	52,405	20,224
	15	66,885	12,670	66,885	14,405	66,885	16,120	66,885	18,373	66,885	20,726	63,541	22,249	53,496	19,574
20	66,885	12,151	66,885	13,622	66,885	15,039	66,885	16,836	66,885	18,677	63,541	19,315	56,112	18,212	

Air-Cooled Scroll Chiller (R410A)

4. Performance Data

■ A(C)CAH020LETB ($\Delta T = 10^{\circ}\text{C}$)

Flow Rate		Outdoor Temperature ($^{\circ}\text{C}$)													
		-15		-10		-5		0		5		10		15	
100 LPM		Capacity (W)	Power Input (W)	Capacity (W)	Power Input (W)	Capacity (W)	Power Input (W)	Capacity (W)	Power Input (W)	Capacity (W)	Power Input (W)	Capacity (W)	Power Input (W)	Capacity (W)	Power Input (W)
Outlet Water Temp. ($^{\circ}\text{C}$)	-10	47,168	10,699	47,168	10,716	47,168	10,785	47,168	10,849	47,168	10,987	47,168	11,838	45,417	12,929
	-5	55,920	11,415	55,920	11,434	55,920	11,507	55,920	11,576	55,920	11,723	55,920	12,631	55,920	14,381
	0	65,510	12,036	65,510	12,055	65,510	12,133	65,510	12,205	65,510	12,360	65,510	13,318	65,510	15,162
	5	69,680	10,152	69,680	10,168	69,680	10,234	69,680	10,295	69,680	10,427	69,680	11,240	69,680	12,807
	7	69,680	9,459	69,680	9,477	69,680	9,538	69,680	9,596	69,680	9,720	69,680	10,488	69,680	11,972
	9	69,680	9,399	69,680	9,415	69,680	9,475	69,680	9,531	69,680	9,650	69,680	10,384	69,680	11,796
	11	69,680	9,338	69,680	9,353	69,680	9,413	69,680	9,467	69,680	9,581	69,680	10,283	69,680	11,625
	13	69,680	9,218	69,680	9,233	69,680	9,292	69,680	9,344	69,680	9,454	69,680	10,129	69,680	11,416
	15	69,680	9,100	69,680	9,115	69,680	9,174	69,680	9,224	69,680	9,329	69,680	9,979	69,680	11,211
20	69,680	8,997	69,680	9,011	69,680	9,070	69,680	9,115	69,680	9,210	69,680	9,795	69,680	10,891	

Flow Rate		Outdoor Temperature ($^{\circ}\text{C}$)													
		20		25		30		35		40		45		48	
100 LPM		Capacity (W)	Power Input (W)	Capacity (W)	Power Input (W)	Capacity (W)	Power Input (W)	Capacity (W)	Power Input (W)	Capacity (W)	Power Input (W)	Capacity (W)	Power Input (W)	Capacity (W)	Power Input (W)
Outlet Water Temp. ($^{\circ}\text{C}$)	-10	42,401	14,022	41,508	15,923	41,508	18,157	40,617	20,787	39,435	23,344	33,512	23,074	25,904	19,026
	-5	55,411	16,492	54,243	18,728	54,243	21,355	53,079	24,448	51,534	27,455	43,794	27,139	33,851	22,377
	0	65,510	17,568	65,510	20,356	65,510	23,212	62,182	25,776	60,372	28,948	51,305	28,614	39,657	23,593
	5	69,680	14,855	69,680	17,233	69,680	19,675	69,680	23,058	69,680	26,731	59,034	26,404	46,582	22,223
	7	69,680	13,918	69,680	16,189	69,680	18,533	69,680	21,803	69,680	25,374	62,177	26,650	49,207	22,488
	9	69,680	13,627	69,680	15,736	69,680	17,884	69,680	20,822	69,680	23,981	63,517	25,220	51,084	21,562
	11	69,680	13,347	69,680	15,308	69,680	17,278	69,680	19,926	69,680	22,733	64,856	24,262	52,962	20,906
	13	69,680	13,056	69,680	14,909	69,680	16,756	69,680	19,211	69,680	21,793	66,021	23,504	54,595	20,385
	15	69,680	12,771	69,680	14,519	69,680	16,248	69,680	18,519	69,680	20,891	66,196	22,426	55,731	19,730
20	69,680	12,248	69,680	13,731	69,680	15,159	69,680	16,970	69,680	18,825	66,196	19,469	58,457	18,357	

Air-Cooled Scroll Chiller (R410A)

4. Performance Data

■ A(C)CAH023LETB ($\Delta T = 5^\circ\text{C}$)

Flow Rate		Outdoor Temperature ($^\circ\text{C}$)													
211 LPM		-15		-10		-5		0		5		10		15	
		Capacity (W)	Power Input (W)	Capacity (W)	Power Input (W)	Capacity (W)	Power Input (W)	Capacity (W)	Power Input (W)	Capacity (W)	Power Input (W)	Capacity (W)	Power Input (W)	Capacity (W)	Power Input (W)
Outlet Water Temp. ($^\circ\text{C}$)	-10	47,548	13,275	47,548	13,296	47,548	13,382	47,548	13,461	47,548	13,633	47,548	14,688	45,783	16,041
	-5	56,370	14,164	56,370	14,187	56,370	14,278	56,370	14,363	56,370	14,546	56,370	15,672	56,370	17,843
	0	66,038	14,934	66,038	14,958	66,038	15,054	66,038	15,143	66,038	15,336	66,038	16,524	66,038	18,813
	5	74,000	13,270	74,000	13,292	74,000	13,378	74,000	13,458	74,000	13,630	74,000	14,692	74,000	16,741
	7	74,000	12,365	74,000	12,388	74,000	12,468	74,000	12,543	74,000	12,706	74,000	13,709	74,000	15,649
	9	74,000	12,287	74,000	12,306	74,000	12,386	74,000	12,458	74,000	12,614	74,000	13,574	74,000	15,419
	11	74,000	12,206	74,000	12,226	74,000	12,305	74,000	12,375	74,000	12,524	74,000	13,442	74,000	15,196
	13	74,000	12,049	74,000	12,069	74,000	12,146	74,000	12,214	74,000	12,357	74,000	13,241	74,000	14,922
	15	74,000	11,896	74,000	11,915	74,000	11,992	74,000	12,057	74,000	12,195	74,000	13,044	74,000	14,654
	20	74,000	11,761	74,000	11,779	74,000	11,855	74,000	11,915	74,000	12,039	74,000	12,803	74,000	14,236

Flow Rate		Outdoor Temperature ($^\circ\text{C}$)													
211 LPM		20		25		30		35		40		45		48	
		Capacity (W)	Power Input (W)	Capacity (W)	Power Input (W)	Capacity (W)	Power Input (W)	Capacity (W)	Power Input (W)	Capacity (W)	Power Input (W)	Capacity (W)	Power Input (W)	Capacity (W)	Power Input (W)
Outlet Water Temp. ($^\circ\text{C}$)	-10	45,030	18,329	44,081	20,814	44,081	23,735	43,135	27,172	37,890	23,805	31,574	23,006	24,285	18,875
	-5	56,370	20,651	56,370	23,955	56,370	27,316	56,370	31,957	49,515	27,997	41,261	27,058	31,736	22,200
	0	66,038	21,798	66,038	25,257	66,038	28,801	66,038	33,694	58,007	29,519	48,337	28,529	37,178	23,407
	5	74,000	19,417	74,000	22,526	74,000	25,718	74,000	30,141	66,950	27,259	55,620	26,326	43,671	22,047
	7	74,000	18,193	74,000	21,162	74,000	24,226	74,000	28,500	67,285	26,004	58,581	26,571	46,131	22,310
	9	74,000	17,812	74,000	20,570	74,000	23,377	74,000	27,218	67,620	24,699	59,843	25,146	47,892	21,392
	11	74,000	17,447	74,000	20,010	74,000	22,586	74,000	26,046	68,289	23,645	61,105	24,190	49,652	20,741
	13	74,000	17,067	74,000	19,489	74,000	21,903	74,000	25,112	70,298	23,334	62,203	23,434	51,183	20,224
	15	74,000	16,694	74,000	18,979	74,000	21,239	74,000	24,208	74,000	26,608	62,368	22,359	52,248	19,574
	20	74,000	16,010	74,000	17,949	74,000	19,815	74,000	22,183	74,000	23,977	62,368	19,411	54,803	18,212

Air-Cooled Scroll Chiller (R410A)

4. Performance Data

■ A(C)CAH023LETB ($\Delta T = 7^{\circ}\text{C}$)

Flow Rate		Outdoor Temperature ($^{\circ}\text{C}$)													
156 LPM		-15		-10		-5		0		5		10		15	
		Capacity (W)	Power Input (W)	Capacity (W)	Power Input (W)	Capacity (W)	Power Input (W)	Capacity (W)	Power Input (W)	Capacity (W)	Power Input (W)	Capacity (W)	Power Input (W)	Capacity (W)	Power Input (W)
Outlet Water Temp. ($^{\circ}\text{C}$)	-10	48,927	13,341	48,927	13,362	48,927	13,449	48,927	13,528	48,927	13,701	48,927	14,762	47,111	16,122
	-5	58,005	14,235	58,005	14,258	58,005	14,350	58,005	14,435	58,005	14,619	58,005	15,751	58,005	17,933
	0	67,953	15,008	67,953	15,032	67,953	15,129	67,953	15,219	67,953	15,413	67,953	16,607	67,953	18,907
	5	76,146	13,336	76,146	13,358	76,146	13,445	76,146	13,525	76,146	13,698	76,146	14,766	76,146	16,825
	7	76,146	12,427	76,146	12,450	76,146	12,530	76,146	12,606	76,146	12,770	76,146	13,778	76,146	15,727
	9	76,146	12,348	76,146	12,368	76,146	12,448	76,146	12,521	76,146	12,677	76,146	13,642	76,146	15,496
	11	76,146	12,267	76,146	12,287	76,146	12,366	76,146	12,436	76,146	12,586	76,146	13,509	76,146	15,272
	13	76,146	12,109	76,146	12,129	76,146	12,207	76,146	12,275	76,146	12,419	76,146	13,307	76,146	14,997
	15	76,146	11,955	76,146	11,975	76,146	12,052	76,146	12,117	76,146	12,256	76,146	13,109	76,146	14,727
	20	76,146	11,819	76,146	11,838	76,146	11,915	76,146	11,974	76,146	12,099	76,146	12,867	76,146	14,307

Flow Rate		Outdoor Temperature ($^{\circ}\text{C}$)													
211 LPM		20		25		30		35		40		45		48	
		Capacity (W)	Power Input (W)	Capacity (W)	Power Input (W)	Capacity (W)	Power Input (W)	Capacity (W)	Power Input (W)	Capacity (W)	Power Input (W)	Capacity (W)	Power Input (W)	Capacity (W)	Power Input (W)
Outlet Water Temp. ($^{\circ}\text{C}$)	-10	46,336	18,421	45,360	20,918	45,360	23,853	44,386	27,307	38,989	23,924	32,489	23,121	24,989	18,970
	-5	58,005	20,754	58,005	24,075	58,005	27,453	58,005	32,117	50,951	28,137	42,458	27,194	32,656	22,311
	0	67,953	21,907	67,953	25,383	67,953	28,945	67,953	33,863	59,689	29,667	49,739	28,672	38,257	23,524
	5	76,146	19,514	76,146	22,639	76,146	25,847	76,146	30,291	68,892	27,395	57,233	26,457	44,937	22,157
	7	76,146	18,284	76,146	21,268	76,146	24,347	76,146	28,643	69,236	26,135	60,280	26,704	47,469	22,422
	9	76,146	17,901	76,146	20,673	76,146	23,494	76,146	27,354	69,580	24,822	61,579	25,271	49,280	21,499
	11	76,146	17,535	76,146	20,110	76,146	22,699	76,146	26,177	70,269	23,763	62,877	24,311	51,092	20,845
	13	76,146	17,152	76,146	19,586	76,146	22,013	76,146	25,237	72,336	23,451	64,007	23,551	52,667	20,325
	15	76,146	16,777	76,146	19,074	76,146	21,345	76,146	24,329	76,146	26,741	64,176	22,471	53,763	19,672
	20	76,146	16,091	76,146	18,038	76,146	19,914	76,146	22,294	76,146	24,097	64,176	19,508	56,392	18,303

Air-Cooled Scroll Chiller (R410A)

4. Performance Data

■ A(C)CAH023LETB ($\Delta T = 10^{\circ}\text{C}$)

Flow Rate		Outdoor Temperature ($^{\circ}\text{C}$)													
		-15		-10		-5		0		5		10		15	
114 LPM		Capacity (W)	Power Input (W)	Capacity (W)	Power Input (W)	Capacity (W)	Power Input (W)	Capacity (W)	Power Input (W)	Capacity (W)	Power Input (W)	Capacity (W)	Power Input (W)	Capacity (W)	Power Input (W)
Outlet Water Temp. ($^{\circ}\text{C}$)	-10	50,971	13,447	50,971	13,469	50,971	13,556	50,971	13,636	50,971	13,810	50,971	14,879	49,079	16,250
	-5	60,429	14,348	60,429	14,371	60,429	14,464	60,429	14,550	60,429	14,735	60,429	15,876	60,429	18,075
	0	70,792	15,128	70,792	15,152	70,792	15,250	70,792	15,340	70,792	15,536	70,792	16,739	70,792	19,058
	5	79,328	13,442	79,328	13,465	79,328	13,552	79,328	13,633	79,328	13,807	79,328	14,883	79,328	16,959
	7	79,328	12,526	79,328	12,549	79,328	12,630	79,328	12,706	79,328	12,871	79,328	13,888	79,328	15,853
	9	79,328	12,446	79,328	12,466	79,328	12,547	79,328	12,620	79,328	12,778	79,328	13,751	79,328	15,619
	11	79,328	12,365	79,328	12,385	79,328	12,465	79,328	12,535	79,328	12,687	79,328	13,616	79,328	15,393
	13	79,328	12,206	79,328	12,225	79,328	12,304	79,328	12,373	79,328	12,518	79,328	13,413	79,328	15,116
	15	79,328	12,051	79,328	12,070	79,328	12,148	79,328	12,214	79,328	12,353	79,328	13,213	79,328	14,845
	20	79,328	11,913	79,328	11,933	79,328	12,010	79,328	12,070	79,328	12,195	79,328	12,970	79,328	14,421

Flow Rate		Outdoor Temperature ($^{\circ}\text{C}$)													
		20		25		30		35		40		45		48	
114 LPM		Capacity (W)	Power Input (W)	Capacity (W)	Power Input (W)	Capacity (W)	Power Input (W)	Capacity (W)	Power Input (W)	Capacity (W)	Power Input (W)	Capacity (W)	Power Input (W)	Capacity (W)	Power Input (W)
Outlet Water Temp. ($^{\circ}\text{C}$)	-10	48,272	18,567	47,255	21,085	47,255	24,043	46,241	27,525	40,618	24,114	33,847	23,305	26,033	19,121
	-5	60,429	20,919	60,429	24,267	60,429	27,671	60,429	32,373	53,080	28,361	44,232	27,410	34,021	22,489
	0	70,792	22,081	70,792	25,585	70,792	29,175	70,792	34,132	62,183	29,903	51,818	28,900	39,855	23,711
	5	79,328	19,670	79,328	22,819	79,328	26,052	79,328	30,532	71,770	27,613	59,625	26,668	46,815	22,334
	7	79,328	18,430	79,328	21,437	79,328	24,540	79,328	28,871	72,129	26,343	62,799	26,916	49,453	22,600
	9	79,328	18,044	79,328	20,837	79,328	23,681	79,328	27,572	72,488	25,020	64,152	25,473	51,340	21,670
	11	79,328	17,674	79,328	20,270	79,328	22,879	79,328	26,385	73,206	23,953	65,505	24,504	53,227	21,011
	13	79,328	17,289	79,328	19,742	79,328	22,188	79,328	25,438	75,359	23,637	66,681	23,739	54,868	20,487
	15	79,328	16,911	79,328	19,226	79,328	21,515	79,328	24,523	79,328	26,954	66,858	22,650	56,010	19,828
	20	79,328	16,219	79,328	18,182	79,328	20,073	79,328	22,472	79,328	24,289	66,858	19,663	58,749	18,449

Air-Cooled Scroll Chiller (R410A)

4. Performance Data

■ A(C)CAH033LETB ($\Delta T = 5^{\circ}\text{C}$)

Flow Rate		Outdoor Temperature ($^{\circ}\text{C}$)													
		-15		-10		-5		0		5		10		15	
327 LPM		Capacity (W)	Power Input (W)	Capacity (W)	Power Input (W)	Capacity (W)	Power Input (W)	Capacity (W)	Power Input (W)	Capacity (W)	Power Input (W)	Capacity (W)	Power Input (W)	Capacity (W)	Power Input (W)
Outlet Water Temp. ($^{\circ}\text{C}$)	-10	86,240	21,123	86,240	21,157	86,240	21,293	86,240	21,419	86,240	21,692	86,240	23,372	83,039	25,525
	-5	103,230	22,392	103,230	22,427	103,230	22,572	103,230	22,706	103,230	22,995	103,230	24,776	103,230	28,208
	0	114,000	21,513	114,000	21,548	114,000	21,686	114,000	21,815	114,000	22,093	114,000	23,804	114,000	27,102
	5	114,000	16,851	114,000	16,879	114,000	16,988	114,000	17,090	114,000	17,309	114,000	18,658	114,000	21,259
	7	114,000	15,702	114,000	15,731	114,000	15,833	114,000	15,928	114,000	16,135	114,000	17,409	114,000	19,873
	9	114,000	15,603	114,000	15,628	114,000	15,729	114,000	15,821	114,000	16,019	114,000	17,238	114,000	19,580
	11	114,000	15,501	114,000	15,526	114,000	15,626	114,000	15,714	114,000	15,904	114,000	17,069	114,000	19,297
	13	114,000	15,301	114,000	15,326	114,000	15,425	114,000	15,510	114,000	15,692	114,000	16,814	114,000	18,950
	15	114,000	15,106	114,000	15,131	114,000	15,228	114,000	15,311	114,000	15,486	114,000	16,564	114,000	18,609
	20	114,000	14,935	114,000	14,959	114,000	15,055	114,000	15,131	114,000	15,288	114,000	16,259	114,000	18,078

Flow Rate		Outdoor Temperature ($^{\circ}\text{C}$)													
		20		25		30		35		40		45		48	
327 LPM		Capacity (W)	Power Input (W)	Capacity (W)	Power Input (W)	Capacity (W)	Power Input (W)	Capacity (W)	Power Input (W)	Capacity (W)	Power Input (W)	Capacity (W)	Power Input (W)	Capacity (W)	Power Input (W)
Outlet Water Temp. ($^{\circ}\text{C}$)	-10	77,525	27,684	75,891	31,437	75,891	35,848	74,263	41,040	72,101	46,088	61,897	45,101	47,845	37,188
	-5	102,327	32,538	100,254	37,377	100,254	42,621	98,103	48,793	95,247	54,795	80,888	53,045	62,524	43,738
	0	114,000	31,401	114,000	36,384	114,000	41,490	114,000	49,146	111,964	56,481	94,760	55,928	73,247	46,115
	5	114,000	24,658	114,000	28,605	114,000	32,659	114,000	38,275	114,000	44,372	107,936	51,088	86,038	43,436
	7	114,000	23,104	114,000	26,873	114,000	30,764	114,000	36,200	114,000	42,120	111,362	50,511	90,885	43,954
	9	114,000	22,620	114,000	26,121	114,000	29,686	114,000	34,564	114,000	39,807	113,761	47,802	94,354	42,145
	11	114,000	22,156	114,000	25,411	114,000	28,681	114,000	33,076	114,000	37,736	114,000	44,585	97,822	40,864
	13	114,000	21,673	114,000	24,749	114,000	27,815	114,000	31,889	114,000	36,175	114,000	42,119	100,838	39,844
	15	114,000	21,199	114,000	24,101	114,000	26,971	114,000	30,741	114,000	34,679	114,000	40,028	102,937	38,564
	20	114,000	20,332	114,000	22,793	114,000	25,163	114,000	28,170	114,000	31,249	114,000	34,750	107,970	35,880

Air-Cooled Scroll Chiller (R410A)

4. Performance Data

■ A(C)CAH033LETB ($\Delta T = 7^{\circ}\text{C}$)

Flow Rate		Outdoor Temperature ($^{\circ}\text{C}$)													
		-15		-10		-5		0		5		10		15	
240 LPM		Capacity (W)	Power Input (W)	Capacity (W)	Power Input (W)	Capacity (W)	Power Input (W)	Capacity (W)	Power Input (W)	Capacity (W)	Power Input (W)	Capacity (W)	Power Input (W)	Capacity (W)	Power Input (W)
Outlet Water Temp. ($^{\circ}\text{C}$)	-10	88,741	21,228	88,741	21,262	88,741	21,399	88,741	21,526	88,741	21,801	88,741	23,489	85,447	25,653
	-5	106,224	22,503	106,224	22,540	106,224	22,685	106,224	22,820	106,224	23,110	106,224	24,900	106,224	28,349
	0	117,306	21,621	117,306	21,655	117,306	21,795	117,306	21,924	117,306	22,204	117,306	23,923	117,306	27,237
	5	117,306	16,935	117,306	16,964	117,306	17,073	117,306	17,175	117,306	17,395	117,306	18,751	117,306	21,365
	7	117,306	15,781	117,306	15,810	117,306	15,912	117,306	16,008	117,306	16,216	117,306	17,497	117,306	19,972
	9	117,306	15,681	117,306	15,706	117,306	15,807	117,306	15,900	117,306	16,099	117,306	17,324	117,306	19,678
	11	117,306	15,578	117,306	15,603	117,306	15,704	117,306	15,793	117,306	15,983	117,306	17,155	117,306	19,393
	13	117,306	15,378	117,306	15,402	117,306	15,502	117,306	15,588	117,306	15,771	117,306	16,898	117,306	19,044
	15	117,306	15,182	117,306	15,206	117,306	15,304	117,306	15,387	117,306	15,564	117,306	16,647	117,306	18,702
	20	117,306	15,009	117,306	15,033	117,306	15,130	117,306	15,206	117,306	15,365	117,306	16,340	117,306	18,168

Flow Rate		Outdoor Temperature ($^{\circ}\text{C}$)													
		20		25		30		35		40		45		48	
240 LPM		Capacity (W)	Power Input (W)	Capacity (W)	Power Input (W)	Capacity (W)	Power Input (W)	Capacity (W)	Power Input (W)	Capacity (W)	Power Input (W)	Capacity (W)	Power Input (W)	Capacity (W)	Power Input (W)
Outlet Water Temp. ($^{\circ}\text{C}$)	-10	79,773	27,823	78,092	31,595	78,092	36,028	76,417	41,245	74,192	46,319	63,692	45,327	49,232	37,373
	-5	105,294	32,701	103,161	37,563	103,161	42,834	100,948	49,037	98,009	55,069	83,234	53,310	64,337	43,956
	0	117,306	31,558	117,306	36,566	117,306	41,697	117,306	49,391	115,211	56,764	97,508	56,208	75,371	46,345
	5	117,306	24,781	117,306	28,748	117,306	32,822	117,306	38,466	117,306	44,594	111,066	51,343	88,533	43,653
	7	117,306	23,219	117,306	27,008	117,306	30,917	117,306	36,373	117,306	42,331	114,591	50,764	93,521	44,174
	9	117,306	22,733	117,306	26,252	117,306	29,834	117,306	34,737	117,306	40,006	117,060	48,041	97,090	42,356
	11	117,306	22,267	117,306	25,538	117,306	28,825	117,306	33,241	117,306	37,924	117,306	44,808	100,659	41,068
	13	117,306	21,782	117,306	24,873	117,306	27,954	117,306	32,048	117,306	36,356	117,306	42,330	103,762	40,043
	15	117,306	21,305	117,306	24,222	117,306	27,106	117,306	30,895	117,306	34,852	117,306	40,228	105,922	38,756
	20	117,306	20,433	117,306	22,907	117,306	25,289	117,306	28,311	117,306	31,406	117,306	34,923	111,101	36,060

Air-Cooled Scroll Chiller (R410A)

4. Performance Data

■ A(C)CAH033LETB ($\Delta T = 10^{\circ}\text{C}$)

Flow Rate		Outdoor Temperature ($^{\circ}\text{C}$)													
		-15		-10		-5		0		5		10		15	
175 LPM		Capacity (W)	Power Input (W)	Capacity (W)	Power Input (W)	Capacity (W)	Power Input (W)	Capacity (W)	Power Input (W)	Capacity (W)	Power Input (W)	Capacity (W)	Power Input (W)	Capacity (W)	Power Input (W)
Outlet Water Temp. ($^{\circ}\text{C}$)	-10	92,449	21,397	92,449	21,432	92,449	21,570	92,449	21,698	92,449	21,974	92,449	23,676	89,018	25,857
	-5	110,663	22,683	110,663	22,719	110,663	22,865	110,663	23,001	110,663	23,294	110,663	25,098	110,663	28,575
	0	122,208	21,793	122,208	21,828	122,208	21,968	122,208	22,099	122,208	22,380	122,208	24,114	122,208	27,454
	5	122,208	17,070	122,208	17,099	122,208	17,209	122,208	17,312	122,208	17,534	122,208	18,900	122,208	21,535
	7	122,208	15,906	122,208	15,935	122,208	16,039	122,208	16,135	122,208	16,345	122,208	17,636	122,208	20,131
	9	122,208	15,806	122,208	15,831	122,208	15,933	122,208	16,026	122,208	16,227	122,208	17,462	122,208	19,835
	11	122,208	15,702	122,208	15,727	122,208	15,829	122,208	15,919	122,208	16,111	122,208	17,291	122,208	19,547
	13	122,208	15,500	122,208	15,525	122,208	15,625	122,208	15,712	122,208	15,896	122,208	17,033	122,208	19,196
	15	122,208	15,303	122,208	15,327	122,208	15,426	122,208	15,510	122,208	15,687	122,208	16,780	122,208	18,851
	20	122,208	15,129	122,208	15,153	122,208	15,251	122,208	15,327	122,208	15,487	122,208	16,470	122,208	18,313

Flow Rate		Outdoor Temperature ($^{\circ}\text{C}$)													
		20		25		30		35		40		45		48	
175 LPM		Capacity (W)	Power Input (W)	Capacity (W)	Power Input (W)	Capacity (W)	Power Input (W)	Capacity (W)	Power Input (W)	Capacity (W)	Power Input (W)	Capacity (W)	Power Input (W)	Capacity (W)	Power Input (W)
Outlet Water Temp. ($^{\circ}\text{C}$)	-10	83,107	28,044	81,355	31,846	81,355	36,314	79,610	41,573	77,292	46,687	66,354	45,687	51,289	37,671
	-5	109,694	32,961	107,472	37,862	107,472	43,175	105,167	49,427	102,105	55,508	86,712	53,735	67,026	44,306
	0	122,208	31,810	122,208	36,857	122,208	42,029	122,208	49,785	120,026	57,216	101,583	56,655	78,521	46,714
	5	122,208	24,978	122,208	28,977	122,208	33,084	122,208	38,773	122,208	44,949	115,707	51,752	92,233	44,001
	7	122,208	23,404	122,208	27,223	122,208	31,164	122,208	36,663	122,208	42,668	119,380	51,168	97,429	44,525
	9	122,208	22,914	122,208	26,461	122,208	30,072	122,208	35,013	122,208	40,325	121,952	48,423	101,147	42,693
	11	122,208	22,444	122,208	25,741	122,208	29,054	122,208	33,506	122,208	38,226	122,208	45,165	104,865	41,395
	13	122,208	21,955	122,208	25,070	122,208	28,176	122,208	32,304	122,208	36,645	122,208	42,666	108,098	40,362
	15	122,208	21,475	122,208	24,415	122,208	27,322	122,208	31,141	122,208	35,130	122,208	40,548	110,348	39,065
	20	122,208	20,596	122,208	23,089	122,208	25,490	122,208	28,536	122,208	31,656	122,208	35,201	115,744	36,347

Air-Cooled Scroll Chiller (R410A)

4. Performance Data

■ A(C)CAH040LETB ($\Delta T = 5^{\circ}\text{C}$)

Flow Rate		Outdoor Temperature ($^{\circ}\text{C}$)													
		-15		-10		-5		0		5		10		15	
372 LPM		Capacity (W)	Power Input (W)	Capacity (W)	Power Input (W)	Capacity (W)	Power Input (W)	Capacity (W)	Power Input (W)	Capacity (W)	Power Input (W)	Capacity (W)	Power Input (W)	Capacity (W)	Power Input (W)
Outlet Water Temp. ($^{\circ}\text{C}$)	-10	88,000	21,123	88,000	21,157	88,000	21,293	88,000	21,419	88,000	21,692	88,000	23,372	84,733	25,525
	-5	104,328	22,538	104,328	22,574	104,328	22,719	104,328	22,854	104,328	23,146	104,328	24,938	104,328	28,392
	0	122,220	23,763	122,220	23,801	122,220	23,954	122,220	24,096	122,220	24,403	122,220	26,294	122,220	29,936
	5	130,000	20,042	130,000	20,076	130,000	20,206	130,000	20,326	130,000	20,587	130,000	22,191	130,000	25,285
	7	130,000	18,676	130,000	18,710	130,000	18,831	130,000	18,945	130,000	19,191	130,000	20,707	130,000	23,636
	9	130,000	18,558	130,000	18,587	130,000	18,707	130,000	18,817	130,000	19,052	130,000	20,502	130,000	23,288
	11	130,000	18,436	130,000	18,466	130,000	18,585	130,000	18,690	130,000	18,916	130,000	20,302	130,000	22,951
	13	130,000	18,199	130,000	18,228	130,000	18,346	130,000	18,447	130,000	18,664	130,000	19,999	130,000	22,538
	15	130,000	17,967	130,000	17,996	130,000	18,112	130,000	18,211	130,000	18,419	130,000	19,701	130,000	22,133
	20	130,000	17,763	130,000	17,792	130,000	17,906	130,000	17,996	130,000	18,184	130,000	19,338	130,000	21,501

Flow Rate		Outdoor Temperature ($^{\circ}\text{C}$)													
		20		25		30		35		40		45		48	
372 LPM		Capacity (W)	Power Input (W)	Capacity (W)	Power Input (W)	Capacity (W)	Power Input (W)	Capacity (W)	Power Input (W)	Capacity (W)	Power Input (W)	Capacity (W)	Power Input (W)	Capacity (W)	Power Input (W)
Outlet Water Temp. ($^{\circ}\text{C}$)	-10	79,107	27,684	77,440	31,437	77,440	35,848	75,779	41,040	73,572	46,088	62,522	45,557	48,328	37,563
	-5	103,378	32,560	101,200	36,975	101,200	42,163	99,029	48,268	96,146	54,206	81,705	53,581	63,156	44,179
	0	122,220	34,685	122,220	40,189	122,220	45,828	116,012	50,891	112,634	57,152	95,718	56,493	73,987	46,580
	5	130,000	29,328	130,000	34,023	130,000	38,844	130,000	45,524	130,000	52,776	110,138	52,130	86,907	43,875
	7	130,000	27,479	130,000	31,963	130,000	36,590	130,000	43,000	130,000	50,097	116,002	52,616	91,803	44,398
	9	130,000	26,904	130,000	31,068	130,000	35,308	130,000	41,110	130,000	47,346	118,501	49,793	95,307	42,571
	11	130,000	26,352	130,000	30,223	130,000	34,113	130,000	39,340	130,000	44,882	121,001	47,900	98,810	41,276
	13	130,000	25,778	130,000	29,436	130,000	33,083	130,000	37,928	130,000	43,026	123,174	46,404	101,857	40,246
	15	130,000	25,214	130,000	28,666	130,000	32,079	130,000	36,563	130,000	41,247	123,500	44,276	103,976	38,953
	20	130,000	24,182	130,000	27,109	130,000	29,928	130,000	33,505	130,000	37,168	123,500	38,438	109,061	36,243

Air-Cooled Scroll Chiller (R410A)

4. Performance Data

■ A(C)CAH040LETB ($\Delta T = 7^{\circ}\text{C}$)

Flow Rate		Outdoor Temperature ($^{\circ}\text{C}$)													
		-15		-10		-5		0		5		10		15	
274 LPM		Capacity (W)	Power Input (W)	Capacity (W)	Power Input (W)	Capacity (W)	Power Input (W)	Capacity (W)	Power Input (W)	Capacity (W)	Power Input (W)	Capacity (W)	Power Input (W)	Capacity (W)	Power Input (W)
Outlet Water Temp. ($^{\circ}\text{C}$)	-10	90,552	21,228	90,552	21,262	90,552	21,399	90,552	21,526	90,552	21,801	90,552	23,489	87,191	25,653
	-5	107,354	22,650	107,354	22,687	107,354	22,833	107,354	22,969	107,354	23,261	107,354	25,063	107,354	28,534
	0	125,764	23,881	125,764	23,920	125,764	24,074	125,764	24,217	125,764	24,525	125,764	26,425	125,764	30,085
	5	133,770	20,143	133,770	20,176	133,770	20,307	133,770	20,428	133,770	20,690	133,770	22,302	133,770	25,412
	7	133,770	18,769	133,770	18,804	133,770	18,925	133,770	19,040	133,770	19,287	133,770	20,810	133,770	23,755
	9	133,770	18,650	133,770	18,680	133,770	18,801	133,770	18,911	133,770	19,148	133,770	20,605	133,770	23,405
	11	133,770	18,529	133,770	18,558	133,770	18,678	133,770	18,784	133,770	19,010	133,770	20,404	133,770	23,066
	13	133,770	18,290	133,770	18,319	133,770	18,437	133,770	18,540	133,770	18,758	133,770	20,099	133,770	22,651
	15	133,770	18,057	133,770	18,086	133,770	18,203	133,770	18,302	133,770	18,511	133,770	19,800	133,770	22,244
	20	133,770	17,852	133,770	17,880	133,770	17,996	133,770	18,086	133,770	18,274	133,770	19,435	133,770	21,609

Flow Rate		Outdoor Temperature ($^{\circ}\text{C}$)													
		20		25		30		35		40		45		48	
274 LPM		Capacity (W)	Power Input (W)	Capacity (W)	Power Input (W)	Capacity (W)	Power Input (W)	Capacity (W)	Power Input (W)	Capacity (W)	Power Input (W)	Capacity (W)	Power Input (W)	Capacity (W)	Power Input (W)
Outlet Water Temp. ($^{\circ}\text{C}$)	-10	81,401	27,823	79,686	31,595	79,686	36,028	77,976	41,245	75,706	46,319	64,335	45,784	49,729	37,751
	-5	106,376	32,723	104,135	37,160	104,135	42,373	101,901	48,509	98,934	54,477	84,075	53,849	64,987	44,400
	0	125,764	34,858	125,764	40,390	125,764	46,057	119,376	51,146	115,901	57,438	98,493	56,775	76,132	46,813
	5	133,770	29,474	133,770	34,193	133,770	39,038	133,770	45,751	133,770	53,040	113,332	52,391	89,427	44,094
	7	133,770	27,616	133,770	32,123	133,770	36,773	133,770	43,262	133,770	50,348	119,366	52,879	94,466	44,620
	9	133,770	27,038	133,770	31,224	133,770	35,485	133,770	41,315	133,770	47,583	121,938	50,042	98,071	42,784
	11	133,770	26,484	133,770	30,374	133,770	34,284	133,770	39,537	133,770	45,107	124,510	48,140	101,676	41,483
	13	133,770	25,907	133,770	29,583	133,770	33,248	133,770	38,118	133,770	43,241	126,746	46,636	104,810	40,448
	15	133,770	25,340	133,770	28,809	133,770	32,239	133,770	36,746	133,770	41,453	127,082	44,497	106,992	39,148
	20	133,770	24,303	133,770	27,245	133,770	30,078	133,770	33,673	133,770	37,353	127,082	38,630	112,223	36,424

Air-Cooled Scroll Chiller (R410A)

4. Performance Data

■ A(C)CAH040LETB ($\Delta T = 10^{\circ}\text{C}$)

Flow Rate		Outdoor Temperature ($^{\circ}\text{C}$)													
200 LPM		-15		-10		-5		0		5		10		15	
		Capacity (W)	Power Input (W)	Capacity (W)	Power Input (W)	Capacity (W)	Power Input (W)	Capacity (W)	Power Input (W)	Capacity (W)	Power Input (W)	Capacity (W)	Power Input (W)	Capacity (W)	Power Input (W)
Outlet Water Temp. ($^{\circ}\text{C}$)	-10	94,336	21,397	94,336	21,432	94,336	21,570	94,336	21,698	94,336	21,974	94,336	23,676	90,834	25,857
	-5	111,840	22,831	111,840	22,867	111,840	23,015	111,840	23,151	111,840	23,446	111,840	25,262	111,840	28,762
	0	131,020	24,072	131,020	24,110	131,020	24,266	131,020	24,410	131,020	24,721	131,020	26,635	131,020	30,325
	5	139,360	20,303	139,360	20,337	139,360	20,468	139,360	20,590	139,360	20,854	139,360	22,479	139,360	25,614
	7	139,360	18,919	139,360	18,953	139,360	19,076	139,360	19,191	139,360	19,440	139,360	20,976	139,360	23,944
	9	139,360	18,799	139,360	18,829	139,360	18,951	139,360	19,061	139,360	19,300	139,360	20,769	139,360	23,591
	11	139,360	18,676	139,360	18,706	139,360	18,827	139,360	18,933	139,360	19,162	139,360	20,566	139,360	23,249
	13	139,360	18,436	139,360	18,465	139,360	18,584	139,360	18,687	139,360	18,907	139,360	20,259	139,360	22,831
	15	139,360	18,201	139,360	18,230	139,360	18,348	139,360	18,447	139,360	18,658	139,360	19,957	139,360	22,421
	20	139,360	17,994	139,360	18,023	139,360	18,139	139,360	18,230	139,360	18,420	139,360	19,589	139,360	21,781

Flow Rate		Outdoor Temperature ($^{\circ}\text{C}$)													
200 LPM		20		25		30		35		40		45		48	
		Capacity (W)	Power Input (W)	Capacity (W)	Power Input (W)	Capacity (W)	Power Input (W)	Capacity (W)	Power Input (W)	Capacity (W)	Power Input (W)	Capacity (W)	Power Input (W)	Capacity (W)	Power Input (W)
Outlet Water Temp. ($^{\circ}\text{C}$)	-10	84,803	28,044	83,016	31,846	83,016	36,314	81,235	41,573	78,869	46,687	67,024	46,149	51,807	38,051
	-5	110,822	32,984	108,486	37,455	108,486	42,711	106,159	48,896	103,068	54,911	87,588	54,277	67,703	44,754
	0	131,020	35,136	131,020	40,712	131,020	46,424	124,365	51,553	120,744	57,895	102,609	57,227	79,314	47,186
	5	139,360	29,709	139,360	34,465	139,360	39,349	139,360	46,116	139,360	53,462	118,068	52,808	93,164	44,445
	7	139,360	27,836	139,360	32,378	139,360	37,066	139,360	43,606	139,360	50,748	124,354	53,300	98,413	44,975
	9	139,360	27,253	139,360	31,472	139,360	35,767	139,360	41,644	139,360	47,961	127,033	50,441	102,169	43,124
	11	139,360	26,695	139,360	30,616	139,360	34,556	139,360	39,852	139,360	45,466	129,713	48,523	105,924	41,813
	13	139,360	26,113	139,360	29,818	139,360	33,513	139,360	38,421	139,360	43,585	132,043	47,007	109,190	40,770
	15	139,360	25,542	139,360	29,039	139,360	32,496	139,360	37,039	139,360	41,783	132,392	44,851	111,463	39,459
	20	139,360	24,496	139,360	27,462	139,360	30,318	139,360	33,941	139,360	37,651	132,392	38,937	116,913	36,714

Air-Cooled Scroll Chiller (R410A)

4. Performance Data

■ A(C)CAH045LETB ($\Delta T = 5^{\circ}\text{C}$)

Flow Rate		Outdoor Temperature ($^{\circ}\text{C}$)													
		-15		-10		-5		0		5		10		15	
422 LPM		Capacity (W)	Power Input (W)	Capacity (W)	Power Input (W)	Capacity (W)	Power Input (W)	Capacity (W)	Power Input (W)	Capacity (W)	Power Input (W)	Capacity (W)	Power Input (W)	Capacity (W)	Power Input (W)
Outlet Water Temp. ($^{\circ}\text{C}$)	-10	95,096	26,549	95,096	26,592	95,096	26,763	95,096	26,922	95,096	27,265	95,096	29,377	91,566	32,083
	-5	112,740	28,328	112,740	28,373	112,740	28,556	112,740	28,726	112,740	29,092	112,740	31,345	112,740	35,687
	0	132,075	29,867	132,075	29,915	132,075	30,108	132,075	30,287	132,075	30,673	132,075	33,048	132,075	37,626
	5	148,000	26,540	148,000	26,584	148,000	26,756	148,000	26,915	148,000	27,260	148,000	29,385	148,000	33,482
	7	148,000	24,730	148,000	24,775	148,000	24,936	148,000	25,086	148,000	25,412	148,000	27,419	148,000	31,298
	9	148,000	24,573	148,000	24,613	148,000	24,772	148,000	24,916	148,000	25,228	148,000	27,148	148,000	30,838
	11	148,000	24,413	148,000	24,452	148,000	24,610	148,000	24,749	148,000	25,048	148,000	26,883	148,000	30,391
	13	148,000	24,098	148,000	24,137	148,000	24,293	148,000	24,427	148,000	24,715	148,000	26,481	148,000	29,844
	15	148,000	23,792	148,000	23,830	148,000	23,984	148,000	24,114	148,000	24,390	148,000	26,088	148,000	29,308
	20	148,000	23,521	148,000	23,559	148,000	23,711	148,000	23,830	148,000	24,078	148,000	25,607	148,000	28,472

Flow Rate		Outdoor Temperature ($^{\circ}\text{C}$)													
		20		25		30		35		40		45		48	
422 LPM		Capacity (W)	Power Input (W)	Capacity (W)	Power Input (W)	Capacity (W)	Power Input (W)	Capacity (W)	Power Input (W)	Capacity (W)	Power Input (W)	Capacity (W)	Power Input (W)	Capacity (W)	Power Input (W)
Outlet Water Temp. ($^{\circ}\text{C}$)	-10	90,060	36,658	88,162	41,628	88,162	47,469	86,271	54,343	75,779	47,609	63,148	46,012	48,569	37,751
	-5	112,740	41,301	112,740	47,910	112,740	54,633	112,740	63,915	99,030	55,995	82,522	54,117	63,471	44,400
	0	132,075	43,596	132,075	50,514	132,075	57,602	132,075	67,389	116,013	59,038	96,675	57,058	74,357	46,813
	5	148,000	38,835	148,000	45,052	148,000	51,436	148,000	60,281	133,900	54,517	111,240	52,652	87,342	44,094
	7	148,000	36,387	148,000	42,324	148,000	48,451	148,000	56,900	134,570	52,009	117,162	53,142	92,262	44,620
	9	148,000	35,625	148,000	41,139	148,000	46,754	148,000	54,436	135,239	49,397	119,686	50,291	95,783	42,784
	11	148,000	34,895	148,000	40,020	148,000	45,171	148,000	52,093	136,578	47,291	122,211	48,379	99,304	41,483
	13	148,000	34,134	148,000	38,978	148,000	43,807	148,000	50,223	140,595	46,668	124,406	46,868	102,366	40,448
	15	148,000	33,388	148,000	37,958	148,000	42,478	148,000	48,416	148,000	53,217	124,735	44,718	104,496	39,148
	20	148,000	32,021	148,000	35,897	148,000	39,630	148,000	44,366	148,000	47,954	124,735	38,822	109,606	36,424

Air-Cooled Scroll Chiller (R410A)

4. Performance Data

■ A(C)CAH045LETB ($\Delta T = 7^{\circ}\text{C}$)

Flow Rate		Outdoor Temperature ($^{\circ}\text{C}$)													
		-15		-10		-5		0		5		10		15	
312 LPM		Capacity (W)	Power Input (W)	Capacity (W)	Power Input (W)	Capacity (W)	Power Input (W)	Capacity (W)	Power Input (W)	Capacity (W)	Power Input (W)	Capacity (W)	Power Input (W)	Capacity (W)	Power Input (W)
Outlet Water Temp. ($^{\circ}\text{C}$)	-10	97,854	26,682	97,854	26,725	97,854	26,897	97,854	27,057	97,854	27,402	97,854	29,524	94,221	32,243
	-5	116,010	28,469	116,010	28,515	116,010	28,699	116,010	28,869	116,010	29,237	116,010	31,502	116,010	35,865
	0	135,905	30,017	135,905	30,065	135,905	30,259	135,905	30,438	135,905	30,826	135,905	33,214	135,905	37,814
	5	152,292	26,672	152,292	26,717	152,292	26,889	152,292	27,050	152,292	27,397	152,292	29,531	152,292	33,649
	7	152,292	24,854	152,292	24,899	152,292	25,060	152,292	25,211	152,292	25,539	152,292	27,556	152,292	31,455
	9	152,292	24,696	152,292	24,736	152,292	24,895	152,292	25,041	152,292	25,355	152,292	27,284	152,292	30,992
	11	152,292	24,535	152,292	24,574	152,292	24,733	152,292	24,873	152,292	25,173	152,292	27,018	152,292	30,543
	13	152,292	24,219	152,292	24,258	152,292	24,414	152,292	24,550	152,292	24,838	152,292	26,614	152,292	29,994
	15	152,292	23,911	152,292	23,949	152,292	24,104	152,292	24,234	152,292	24,512	152,292	26,218	152,292	29,455
	20	152,292	23,639	152,292	23,677	152,292	23,829	152,292	23,949	152,292	24,198	152,292	25,735	152,292	28,614

Flow Rate		Outdoor Temperature ($^{\circ}\text{C}$)													
		20		25		30		35		40		45		48	
312 LPM		Capacity (W)	Power Input (W)	Capacity (W)	Power Input (W)	Capacity (W)	Power Input (W)	Capacity (W)	Power Input (W)	Capacity (W)	Power Input (W)	Capacity (W)	Power Input (W)	Capacity (W)	Power Input (W)
Outlet Water Temp. ($^{\circ}\text{C}$)	-10	92,672	36,842	90,719	41,836	90,719	47,707	88,773	54,615	77,977	47,847	64,979	46,242	49,978	37,940
	-5	116,010	41,508	116,010	48,150	116,010	54,906	116,010	64,235	101,902	56,275	84,915	54,387	65,312	44,622
	0	135,905	43,814	135,905	50,767	135,905	57,890	135,905	67,726	119,378	59,333	99,478	57,343	76,513	47,047
	5	152,292	39,029	152,292	45,277	152,292	51,693	152,292	60,582	137,783	54,790	114,466	52,915	89,874	44,315
	7	152,292	36,569	152,292	42,536	152,292	48,693	152,292	57,285	138,472	52,269	120,559	53,408	94,938	44,843
	9	152,292	35,803	152,292	41,345	152,292	46,987	152,292	54,708	139,161	49,644	123,157	50,543	98,561	42,998
	11	152,292	35,069	152,292	40,220	152,292	45,397	152,292	52,353	140,539	47,527	125,755	48,621	102,184	41,690
	13	152,292	34,305	152,292	39,173	152,292	44,026	152,292	50,474	144,672	46,901	128,013	47,103	105,334	40,650
	15	152,292	33,555	152,292	38,148	152,292	42,690	152,292	48,658	152,292	53,483	128,352	44,942	107,527	39,344
	20	152,292	32,181	152,292	36,077	152,292	39,828	152,292	44,588	152,292	48,194	128,352	39,016	112,785	36,606

Air-Cooled Scroll Chiller (R410A)

4. Performance Data

■ A(C)CAH045LETB ($\Delta T = 10^{\circ}\text{C}$)

Flow Rate		Outdoor Temperature ($^{\circ}\text{C}$)													
227 LPM		-15		-10		-5		0		5		10		15	
		Capacity (W)	Power Input (W)	Capacity (W)	Power Input (W)	Capacity (W)	Power Input (W)	Capacity (W)	Power Input (W)	Capacity (W)	Power Input (W)	Capacity (W)	Power Input (W)	Capacity (W)	Power Input (W)
Outlet Water Temp. ($^{\circ}\text{C}$)	-10	101,943	26,894	101,943	26,938	101,943	27,111	101,943	27,272	101,943	27,620	101,943	29,759	98,159	32,500
	-5	120,858	28,696	120,858	28,742	120,858	28,927	120,858	29,099	120,858	29,470	120,858	31,752	120,858	36,151
	0	141,585	30,256	141,585	30,304	141,585	30,500	141,585	30,681	141,585	31,072	141,585	33,478	141,585	38,115
	5	158,656	26,885	158,656	26,929	158,656	27,103	158,656	27,265	158,656	27,615	158,656	29,767	158,656	33,917
	7	158,656	25,052	158,656	25,097	158,656	25,260	158,656	25,412	158,656	25,742	158,656	27,775	158,656	31,705
	9	158,656	24,893	158,656	24,933	158,656	25,094	158,656	25,240	158,656	25,556	158,656	27,501	158,656	31,239
	11	158,656	24,730	158,656	24,770	158,656	24,930	158,656	25,071	158,656	25,373	158,656	27,233	158,656	30,786
	13	158,656	24,412	158,656	24,451	158,656	24,609	158,656	24,745	158,656	25,036	158,656	26,826	158,656	30,232
	15	158,656	24,101	158,656	24,140	158,656	24,295	158,656	24,427	158,656	24,707	158,656	26,427	158,656	29,689
20	158,656	23,827	158,656	23,865	158,656	24,019	158,656	24,139	158,656	24,391	158,656	25,940	158,656	28,842	

Flow Rate		Outdoor Temperature ($^{\circ}\text{C}$)													
227 LPM		20		25		30		35		40		45		48	
		Capacity (W)	Power Input (W)	Capacity (W)	Power Input (W)	Capacity (W)	Power Input (W)	Capacity (W)	Power Input (W)	Capacity (W)	Power Input (W)	Capacity (W)	Power Input (W)	Capacity (W)	Power Input (W)
Outlet Water Temp. ($^{\circ}\text{C}$)	-10	96,545	37,135	94,510	42,170	94,510	48,086	92,482	55,050	81,236	48,228	67,694	46,610	52,066	38,242
	-5	120,858	41,838	120,858	48,533	120,858	55,343	120,858	64,746	106,160	56,723	88,464	54,820	68,041	44,977
	0	141,585	44,162	141,585	51,171	141,585	58,350	141,585	68,265	124,366	59,806	103,635	57,800	79,710	47,422
	5	158,656	39,340	158,656	45,638	158,656	52,105	158,656	61,065	143,541	55,226	119,249	53,336	93,630	44,667
	7	158,656	36,860	158,656	42,874	158,656	49,081	158,656	57,741	144,259	52,685	125,597	53,833	98,905	45,200
	9	158,656	36,088	158,656	41,674	158,656	47,361	158,656	55,144	144,976	50,040	128,304	50,945	102,680	43,340
	11	158,656	35,349	158,656	40,540	158,656	45,758	158,656	52,770	146,412	47,905	131,010	49,008	106,454	42,022
	13	158,656	34,578	158,656	39,485	158,656	44,376	158,656	50,876	150,718	47,275	133,363	47,478	109,736	40,973
	15	158,656	33,822	158,656	38,452	158,656	43,030	158,656	49,045	158,656	53,909	133,716	45,300	112,020	39,657
20	158,656	32,437	158,656	36,364	158,656	40,145	158,656	44,943	158,656	48,577	133,716	39,327	117,498	36,897	

Air-Cooled Scroll Chiller (R410A)

4. Performance Data

■ A(C)CAH050LETB ($\Delta T = 5^{\circ}\text{C}$)

Flow Rate		Outdoor Temperature ($^{\circ}\text{C}$)													
		-15		-10		-5		0		5		10		15	
491 LPM		Capacity (W)	Power Input (W)	Capacity (W)	Power Input (W)	Capacity (W)	Power Input (W)	Capacity (W)	Power Input (W)	Capacity (W)	Power Input (W)	Capacity (W)	Power Input (W)	Capacity (W)	Power Input (W)
Outlet Water Temp. ($^{\circ}\text{C}$)	-10	129,360	31,684	129,360	31,735	129,360	31,940	129,360	32,129	129,360	32,539	129,360	35,059	124,558	38,288
	-5	154,845	33,587	154,845	33,641	154,845	33,858	154,845	34,059	154,845	34,493	154,845	37,165	154,845	42,312
	0	171,000	32,270	171,000	32,321	171,000	32,530	171,000	32,723	171,000	33,140	171,000	35,706	171,000	40,652
	5	171,000	25,277	171,000	25,319	171,000	25,482	171,000	25,634	171,000	25,963	171,000	27,986	171,000	31,889
	7	171,000	23,553	171,000	23,596	171,000	23,749	171,000	23,892	171,000	24,203	171,000	26,114	171,000	29,809
	9	171,000	23,404	171,000	23,442	171,000	23,593	171,000	23,731	171,000	24,028	171,000	25,857	171,000	29,370
	11	171,000	23,251	171,000	23,288	171,000	23,439	171,000	23,571	171,000	23,856	171,000	25,604	171,000	28,945
	13	171,000	22,952	171,000	22,989	171,000	23,137	171,000	23,265	171,000	23,539	171,000	25,221	171,000	28,424
	15	171,000	22,660	171,000	22,696	171,000	22,842	171,000	22,966	171,000	23,229	171,000	24,846	171,000	27,914
	20	171,000	22,402	171,000	22,438	171,000	22,583	171,000	22,696	171,000	22,932	171,000	24,388	171,000	27,117

Flow Rate		Outdoor Temperature ($^{\circ}\text{C}$)													
		20		25		30		35		40		45		48	
491 LPM		Capacity (W)	Power Input (W)	Capacity (W)	Power Input (W)	Capacity (W)	Power Input (W)	Capacity (W)	Power Input (W)	Capacity (W)	Power Input (W)	Capacity (W)	Power Input (W)	Capacity (W)	Power Input (W)
Outlet Water Temp. ($^{\circ}\text{C}$)	-10	116,287	41,526	113,837	47,156	113,837	53,773	111,394	61,559	108,151	69,132	92,846	67,652	71,767	55,781
	-5	153,490	48,807	150,381	56,065	150,381	63,931	147,155	73,189	142,870	82,193	121,332	79,568	93,786	65,606
	0	171,000	47,102	171,000	54,577	171,000	62,234	171,000	73,719	167,946	84,722	142,141	83,892	109,870	69,172
	5	171,000	36,987	171,000	42,908	171,000	48,988	171,000	57,413	171,000	66,558	161,904	76,631	129,057	65,154
	7	171,000	34,655	171,000	40,310	171,000	46,146	171,000	54,300	171,000	63,180	167,043	75,767	136,328	65,931
	9	171,000	33,930	171,000	39,182	171,000	44,529	171,000	51,846	171,000	59,711	170,642	71,702	141,530	63,218
	11	171,000	33,234	171,000	38,116	171,000	43,022	171,000	49,614	171,000	56,603	171,000	66,878	146,733	61,295
	13	171,000	32,510	171,000	37,123	171,000	41,722	171,000	47,833	171,000	54,262	171,000	63,178	151,257	59,766
	15	171,000	31,799	171,000	36,152	171,000	40,456	171,000	46,112	171,000	52,018	171,000	60,041	154,405	57,845
	20	171,000	30,497	171,000	34,189	171,000	37,744	171,000	42,255	171,000	46,874	171,000	52,125	161,955	53,820

Air-Cooled Scroll Chiller (R410A)

4. Performance Data

■ A(C)CAH050LETB ($\Delta T = 7^{\circ}\text{C}$)

Flow Rate		Outdoor Temperature ($^{\circ}\text{C}$)													
		-15		-10		-5		0		5		10		15	
360 LPM		Capacity (W)	Power Input (W)	Capacity (W)	Power Input (W)	Capacity (W)	Power Input (W)	Capacity (W)	Power Input (W)	Capacity (W)	Power Input (W)	Capacity (W)	Power Input (W)	Capacity (W)	Power Input (W)
Outlet Water Temp. ($^{\circ}\text{C}$)	-10	133,111	31,842	133,111	31,894	133,111	32,099	133,111	32,290	133,111	32,701	133,111	35,234	128,170	38,479
	-5	159,336	33,755	159,336	33,809	159,336	34,027	159,336	34,229	159,336	34,666	159,336	37,350	159,336	42,524
	0	175,959	32,431	175,959	32,483	175,959	32,692	175,959	32,886	175,959	33,305	175,959	35,885	175,959	40,856
	5	175,959	25,403	175,959	25,446	175,959	25,610	175,959	25,763	175,959	26,093	175,959	28,126	175,959	32,048
	7	175,959	23,671	175,959	23,714	175,959	23,868	175,959	24,012	175,959	24,324	175,959	26,245	175,959	29,958
	9	175,959	23,521	175,959	23,559	175,959	23,711	175,959	23,849	175,959	24,148	175,959	25,986	175,959	29,517
	11	175,959	23,367	175,959	23,405	175,959	23,556	175,959	23,689	175,959	23,975	175,959	25,732	175,959	29,090
	13	175,959	23,066	175,959	23,103	175,959	23,252	175,959	23,381	175,959	23,656	175,959	25,347	175,959	28,566
	15	175,959	22,773	175,959	22,810	175,959	22,957	175,959	23,081	175,959	23,345	175,959	24,971	175,959	28,053
	20	175,959	22,514	175,959	22,550	175,959	22,695	175,959	22,809	175,959	23,047	175,959	24,510	175,959	27,252

Flow Rate		Outdoor Temperature ($^{\circ}\text{C}$)													
		20		25		30		35		40		45		48	
360 LPM		Capacity (W)	Power Input (W)	Capacity (W)	Power Input (W)	Capacity (W)	Power Input (W)	Capacity (W)	Power Input (W)	Capacity (W)	Power Input (W)	Capacity (W)	Power Input (W)	Capacity (W)	Power Input (W)
Outlet Water Temp. ($^{\circ}\text{C}$)	-10	119,660	41,734	117,138	47,392	117,138	54,042	114,625	61,867	111,288	69,478	95,538	67,990	73,848	56,060
	-5	157,941	49,051	154,742	56,345	154,742	64,251	151,422	73,555	147,013	82,604	124,851	79,965	96,506	65,934
	0	175,959	47,338	175,959	54,850	175,959	62,546	175,959	74,087	172,817	85,146	146,263	84,311	113,057	69,518
	5	175,959	37,172	175,959	43,123	175,959	49,233	175,959	57,700	175,959	66,891	166,599	77,015	132,800	65,480
	7	175,959	34,829	175,959	40,512	175,959	46,376	175,959	54,560	175,959	63,496	171,887	76,146	140,281	66,261
	9	175,959	34,099	175,959	39,378	175,959	44,752	175,959	52,105	175,959	60,009	175,590	72,061	145,635	63,534
	11	175,959	33,401	175,959	38,306	175,959	43,237	175,959	49,862	175,959	56,886	175,959	67,212	150,988	61,602
	13	175,959	32,672	175,959	37,309	175,959	41,931	175,959	48,073	175,959	54,534	175,959	63,494	155,643	60,065
	15	175,959	31,958	175,959	36,333	175,959	40,659	175,959	46,343	175,959	52,279	175,959	60,342	158,883	58,135
	20	175,959	30,650	175,959	34,360	175,959	37,933	175,959	42,466	175,959	47,108	175,959	52,385	166,652	54,089

Air-Cooled Scroll Chiller (R410A)

4. Performance Data

■ A(C)CAH050LETB ($\Delta T = 10^{\circ}\text{C}$)

Flow Rate		Outdoor Temperature ($^{\circ}\text{C}$)													
		-15		-10		-5		0		5		10		15	
263 LPM		Capacity (W)	Power Input (W)	Capacity (W)	Power Input (W)	Capacity (W)	Power Input (W)	Capacity (W)	Power Input (W)	Capacity (W)	Power Input (W)	Capacity (W)	Power Input (W)	Capacity (W)	Power Input (W)
Outlet Water Temp. ($^{\circ}\text{C}$)	-10	138,674	32,096	138,674	32,147	138,674	32,355	138,674	32,547	138,674	32,962	138,674	35,514	133,526	38,786
	-5	165,994	34,024	165,994	34,078	165,994	34,298	165,994	34,502	165,994	34,941	165,994	37,648	165,994	42,862
	0	183,312	32,689	183,312	32,741	183,312	32,953	183,312	33,148	183,312	33,571	183,312	36,171	183,312	41,181
	5	183,312	25,605	183,312	25,648	183,312	25,814	183,312	25,968	183,312	26,301	183,312	28,350	183,312	32,303
	7	183,312	23,860	183,312	23,903	183,312	24,058	183,312	24,203	183,312	24,517	183,312	26,454	183,312	30,197
	9	183,312	23,708	183,312	23,746	183,312	23,900	183,312	24,039	183,312	24,340	183,312	26,193	183,312	29,752
	11	183,312	23,553	183,312	23,591	183,312	23,743	183,312	23,878	183,312	24,166	183,312	25,937	183,312	29,321
	13	183,312	23,250	183,312	23,287	183,312	23,438	183,312	23,568	183,312	23,845	183,312	25,549	183,312	28,794
	15	183,312	22,954	183,312	22,991	183,312	23,139	183,312	23,265	183,312	23,531	183,312	25,169	183,312	28,276
	20	183,312	22,693	183,312	22,730	183,312	22,876	183,312	22,991	183,312	23,230	183,312	24,705	183,312	27,469

Flow Rate		Outdoor Temperature ($^{\circ}\text{C}$)													
		20		25		30		35		40		45		48	
263 LPM		Capacity (W)	Power Input (W)	Capacity (W)	Power Input (W)	Capacity (W)	Power Input (W)	Capacity (W)	Power Input (W)	Capacity (W)	Power Input (W)	Capacity (W)	Power Input (W)	Capacity (W)	Power Input (W)
Outlet Water Temp. ($^{\circ}\text{C}$)	-10	124,660	42,066	122,033	47,769	122,033	54,472	119,415	62,360	115,938	70,031	99,530	68,531	76,934	56,506
	-5	164,541	49,442	161,208	56,794	161,208	64,763	157,750	74,141	153,157	83,261	130,068	80,602	100,539	66,459
	0	183,312	47,714	183,312	55,286	183,312	63,043	183,312	74,677	180,039	85,823	152,375	84,983	117,781	70,071
	5	183,312	37,468	183,312	43,466	183,312	49,625	183,312	58,159	183,312	67,424	173,561	77,628	138,349	66,001
	7	183,312	35,106	183,312	40,834	183,312	46,745	183,312	54,994	183,312	64,001	179,070	76,752	146,143	66,788
	9	183,312	34,371	183,312	39,691	183,312	45,108	183,312	52,520	183,312	60,487	182,928	72,634	151,721	64,040
	11	183,312	33,666	183,312	38,611	183,312	43,581	183,312	50,259	183,312	57,339	183,312	67,747	157,298	62,092
	13	183,312	32,932	183,312	37,606	183,312	42,265	183,312	48,455	183,312	54,968	183,312	64,000	162,148	60,543
	15	183,312	32,212	183,312	36,622	183,312	40,982	183,312	46,712	183,312	52,695	183,312	60,822	165,522	58,597
	20	183,312	30,894	183,312	34,634	183,312	38,235	183,312	42,805	183,312	47,483	183,312	52,802	173,616	54,520

Air-Cooled Scroll Chiller (R410A)

4. Performance Data

■ A(C)CAH060LETB ($\Delta T = 5^{\circ}\text{C}$)

Flow Rate		Outdoor Temperature ($^{\circ}\text{C}$)													
		-15		-10		-5		0		5		10		15	
558 LPM		Capacity (W)	Power Input (W)	Capacity (W)	Power Input (W)	Capacity (W)	Power Input (W)	Capacity (W)	Power Input (W)	Capacity (W)	Power Input (W)	Capacity (W)	Power Input (W)	Capacity (W)	Power Input (W)
Outlet Water Temp. ($^{\circ}\text{C}$)	-10	132,000	31,684	132,000	31,735	132,000	31,940	132,000	32,129	132,000	32,539	132,000	35,059	127,100	38,288
	-5	156,492	33,807	156,492	33,861	156,492	34,079	156,492	34,281	156,492	34,718	156,492	37,407	156,492	42,589
	0	183,330	35,644	183,330	35,701	183,330	35,931	183,330	36,145	183,330	36,605	183,330	39,440	183,330	44,903
	5	195,000	30,064	195,000	30,114	195,000	30,308	195,000	30,489	195,000	30,880	195,000	33,286	195,000	37,928
	7	195,000	28,014	195,000	28,065	195,000	28,247	195,000	28,417	195,000	28,786	195,000	31,060	195,000	35,455
	9	195,000	27,837	195,000	27,881	195,000	28,061	195,000	28,225	195,000	28,579	195,000	30,753	195,000	34,933
	11	195,000	27,655	195,000	27,699	195,000	27,878	195,000	28,035	195,000	28,374	195,000	30,453	195,000	34,427
	13	195,000	27,298	195,000	27,342	195,000	27,519	195,000	27,671	195,000	27,997	195,000	29,998	195,000	33,807
	15	195,000	26,951	195,000	26,994	195,000	27,168	195,000	27,316	195,000	27,629	195,000	29,552	195,000	33,200
	20	195,000	26,645	195,000	26,687	195,000	26,859	195,000	26,994	195,000	27,275	195,000	29,007	195,000	32,252

Flow Rate		Outdoor Temperature ($^{\circ}\text{C}$)													
		20		25		30		35		40		45		48	
558 LPM		Capacity (W)	Power Input (W)	Capacity (W)	Power Input (W)	Capacity (W)	Power Input (W)	Capacity (W)	Power Input (W)	Capacity (W)	Power Input (W)	Capacity (W)	Power Input (W)	Capacity (W)	Power Input (W)
Outlet Water Temp. ($^{\circ}\text{C}$)	-10	118,660	41,526	116,160	47,156	116,160	53,773	113,668	61,559	110,358	69,132	93,783	68,335	72,492	56,345
	-5	155,068	48,841	151,800	55,462	151,800	63,244	148,543	72,402	144,218	81,309	122,558	80,371	94,734	66,269
	0	183,330	52,027	183,330	60,284	183,330	68,742	174,018	76,337	168,951	85,728	143,576	84,739	110,980	69,871
	5	195,000	43,992	195,000	51,034	195,000	58,266	195,000	68,286	195,000	79,164	165,208	78,195	130,361	65,812
	7	195,000	41,219	195,000	47,944	195,000	54,885	195,000	64,600	195,000	75,146	174,003	78,924	137,705	66,597
	9	195,000	40,355	195,000	46,602	195,000	52,962	195,000	61,665	195,000	71,019	177,752	74,690	142,960	63,857
	11	195,000	39,529	195,000	45,334	195,000	51,169	195,000	59,010	195,000	67,323	181,501	71,851	148,215	61,915
	13	195,000	38,667	195,000	44,154	195,000	49,624	195,000	56,892	195,000	64,539	184,761	69,606	152,785	60,369
	15	195,000	37,821	195,000	42,999	195,000	48,118	195,000	54,845	195,000	61,870	185,250	66,413	155,965	58,430
	20	195,000	36,273	195,000	40,664	195,000	44,893	195,000	50,258	195,000	55,751	185,250	57,657	163,591	54,364

Air-Cooled Scroll Chiller (R410A)

4. Performance Data

■ A(C)CAH060LETB ($\Delta T = 7^{\circ}\text{C}$)

Flow Rate		Outdoor Temperature ($^{\circ}\text{C}$)													
		-15		-10		-5		0		5		10		15	
411 LPM		Capacity (W)	Power Input (W)	Capacity (W)	Power Input (W)	Capacity (W)	Power Input (W)	Capacity (W)	Power Input (W)	Capacity (W)	Power Input (W)	Capacity (W)	Power Input (W)	Capacity (W)	Power Input (W)
Outlet Water Temp. ($^{\circ}\text{C}$)	-10	135,828	31,842	135,828	31,894	135,828	32,099	135,828	32,290	135,828	32,701	135,828	35,234	130,786	38,479
	-5	161,030	33,976	161,030	34,030	161,030	34,250	161,030	34,453	161,030	34,892	161,030	37,594	161,030	42,802
	0	188,647	35,822	188,647	35,880	188,647	36,111	188,647	36,325	188,647	36,788	188,647	39,637	188,647	45,128
	5	200,655	30,214	200,655	30,265	200,655	30,460	200,655	30,642	200,655	31,035	200,655	33,453	200,655	38,118
	7	200,655	28,154	200,655	28,205	200,655	28,388	200,655	28,559	200,655	28,930	200,655	31,215	200,655	35,632
	9	200,655	27,976	200,655	28,021	200,655	28,201	200,655	28,366	200,655	28,721	200,655	30,907	200,655	35,107
	11	200,655	27,793	200,655	27,837	200,655	28,017	200,655	28,176	200,655	28,516	200,655	30,606	200,655	34,599
	13	200,655	27,435	200,655	27,479	200,655	27,656	200,655	27,810	200,655	28,137	200,655	30,148	200,655	33,977
	15	200,655	27,086	200,655	27,129	200,655	27,304	200,655	27,452	200,655	27,767	200,655	29,700	200,655	33,366
	20	200,655	26,778	200,655	26,821	200,655	26,994	200,655	27,129	200,655	27,412	200,655	29,152	200,655	32,413

Flow Rate		Outdoor Temperature ($^{\circ}\text{C}$)													
		20		25		30		35		40		45		48	
411 LPM		Capacity (W)	Power Input (W)	Capacity (W)	Power Input (W)	Capacity (W)	Power Input (W)	Capacity (W)	Power Input (W)	Capacity (W)	Power Input (W)	Capacity (W)	Power Input (W)	Capacity (W)	Power Input (W)
Outlet Water Temp. ($^{\circ}\text{C}$)	-10	122,102	41,734	119,529	47,392	119,529	54,042	116,964	61,867	113,559	69,478	96,503	68,677	74,594	56,626
	-5	159,565	49,085	156,202	55,739	156,202	63,560	152,851	72,764	148,401	81,716	126,112	80,773	97,481	66,600
	0	188,647	52,288	188,647	60,585	188,647	69,086	179,065	76,719	173,851	86,157	147,740	85,163	114,199	70,220
	5	200,655	44,212	200,655	51,290	200,655	58,557	200,655	68,627	200,655	79,559	169,999	78,586	134,141	66,141
	7	200,655	41,425	200,655	48,184	200,655	55,159	200,655	64,892	200,655	75,521	179,049	79,319	141,698	66,930
	9	200,655	40,557	200,655	46,835	200,655	53,227	200,655	61,973	200,655	71,374	182,907	75,063	147,106	64,176
	11	200,655	39,726	200,655	45,561	200,655	51,425	200,655	59,305	200,655	67,660	186,764	72,210	152,513	62,224
	13	200,655	38,860	200,655	44,375	200,655	49,872	200,655	57,177	200,655	64,862	190,119	69,954	157,216	60,671
	15	200,655	38,010	200,655	43,214	200,655	48,359	200,655	55,119	200,655	62,179	190,622	66,746	160,488	58,722
	20	200,655	36,454	200,655	40,867	200,655	45,117	200,655	50,509	200,655	56,030	190,622	57,945	168,335	54,636

Air-Cooled Scroll Chiller (R410A)

4. Performance Data

■ A(C)CAH060LETB ($\Delta T = 10^{\circ}\text{C}$)

Flow Rate		Outdoor Temperature ($^{\circ}\text{C}$)													
		-15		-10		-5		0		5		10		15	
300 LPM		Capacity (W)	Power Input (W)	Capacity (W)	Power Input (W)	Capacity (W)	Power Input (W)	Capacity (W)	Power Input (W)	Capacity (W)	Power Input (W)	Capacity (W)	Power Input (W)	Capacity (W)	Power Input (W)
Outlet Water Temp. ($^{\circ}\text{C}$)	-10	141,504	32,096	141,504	32,147	141,504	32,355	141,504	32,547	141,504	32,962	141,504	35,514	136,251	38,786
	-5	167,759	34,246	167,759	34,301	167,759	34,522	167,759	34,727	167,759	35,170	167,759	37,894	167,759	43,142
	0	196,530	36,107	196,530	36,165	196,530	36,398	196,530	36,614	196,530	37,081	196,530	39,953	196,530	45,487
	5	209,040	30,455	209,040	30,505	209,040	30,702	209,040	30,886	209,040	31,282	209,040	33,719	209,040	38,421
	7	209,040	28,378	209,040	28,430	209,040	28,614	209,040	28,787	209,040	29,161	209,040	31,464	209,040	35,915
	9	209,040	28,198	209,040	28,244	209,040	28,426	209,040	28,592	209,040	28,950	209,040	31,153	209,040	35,387
	11	209,040	28,014	209,040	28,059	209,040	28,240	209,040	28,400	209,040	28,743	209,040	30,849	209,040	34,874
	13	209,040	27,653	209,040	27,698	209,040	27,876	209,040	28,031	209,040	28,361	209,040	30,388	209,040	34,247
	15	209,040	27,301	209,040	27,345	209,040	27,522	209,040	27,671	209,040	27,988	209,040	29,936	209,040	33,632
	20	209,040	26,991	209,040	27,034	209,040	27,209	209,040	27,345	209,040	27,630	209,040	29,384	209,040	32,672

Flow Rate		Outdoor Temperature ($^{\circ}\text{C}$)													
		20		25		30		35		40		45		48	
300 LPM		Capacity (W)	Power Input (W)	Capacity (W)	Power Input (W)	Capacity (W)	Power Input (W)	Capacity (W)	Power Input (W)	Capacity (W)	Power Input (W)	Capacity (W)	Power Input (W)	Capacity (W)	Power Input (W)
Outlet Water Temp. ($^{\circ}\text{C}$)	-10	127,204	42,066	124,524	47,769	124,524	54,472	121,852	62,360	118,304	70,031	100,536	69,223	77,711	57,077
	-5	166,233	49,475	162,730	56,183	162,730	64,066	159,238	73,343	154,602	82,366	131,382	81,416	101,554	67,131
	0	196,530	52,704	196,530	61,067	196,530	69,636	186,547	77,329	181,116	86,843	153,914	85,841	118,971	70,779
	5	209,040	44,564	209,040	51,698	209,040	59,024	209,040	69,173	209,040	80,193	177,103	79,212	139,747	66,668
	7	209,040	41,754	209,040	48,568	209,040	55,598	209,040	65,409	209,040	76,122	186,531	79,950	147,620	67,463
	9	209,040	40,880	209,040	47,208	209,040	53,651	209,040	62,466	209,040	71,942	190,550	75,661	153,253	64,687
	11	209,040	40,042	209,040	45,924	209,040	51,835	209,040	59,777	209,040	68,198	194,569	72,785	158,887	62,719
	13	209,040	39,169	209,040	44,728	209,040	50,269	209,040	57,632	209,040	65,378	198,064	70,511	163,785	61,154
	15	209,040	38,313	209,040	43,558	209,040	48,744	209,040	55,558	209,040	62,674	198,588	67,277	167,194	59,189
	20	209,040	36,745	209,040	41,193	209,040	45,476	209,040	50,911	209,040	56,476	198,588	58,406	175,370	55,071

Air-Cooled Scroll Chiller (R410A)

4. Performance Data

■ A(C)CAH067LETB ($\Delta T = 5^{\circ}\text{C}$)

Flow Rate		Outdoor Temperature ($^{\circ}\text{C}$)													
		-15		-10		-5		0		5		10		15	
633 LPM		Capacity (W)	Power Input (W)	Capacity (W)	Power Input (W)	Capacity (W)	Power Input (W)	Capacity (W)	Power Input (W)	Capacity (W)	Power Input (W)	Capacity (W)	Power Input (W)	Capacity (W)	Power Input (W)
Outlet Water Temp. ($^{\circ}\text{C}$)	-10	142,644	39,824	142,644	39,888	142,644	40,145	142,644	40,383	142,644	40,898	142,644	44,065	137,349	48,124
	-5	169,111	42,492	169,111	42,560	169,111	42,834	169,111	43,089	169,111	43,638	169,111	47,017	169,111	53,530
	0	198,113	44,801	198,113	44,873	198,113	45,162	198,113	45,430	198,113	46,009	198,113	49,573	198,113	56,439
	5	222,000	39,809	222,000	39,876	222,000	40,133	222,000	40,373	222,000	40,890	222,000	44,077	222,000	50,223
	7	222,000	37,095	222,000	37,163	222,000	37,403	222,000	37,629	222,000	38,118	222,000	41,128	222,000	46,948
	9	222,000	36,860	222,000	36,919	222,000	37,157	222,000	37,375	222,000	37,843	222,000	40,723	222,000	46,257
	11	222,000	36,619	222,000	36,678	222,000	36,915	222,000	37,124	222,000	37,571	222,000	40,325	222,000	45,587
	13	222,000	36,148	222,000	36,206	222,000	36,439	222,000	36,641	222,000	37,072	222,000	39,722	222,000	44,767
	15	222,000	35,688	222,000	35,745	222,000	35,976	222,000	36,171	222,000	36,585	222,000	39,132	222,000	43,962
	20	222,000	35,282	222,000	35,338	222,000	35,566	222,000	35,745	222,000	36,117	222,000	38,410	222,000	42,707

Flow Rate		Outdoor Temperature ($^{\circ}\text{C}$)													
		20		25		30		35		40		45		48	
633 LPM		Capacity (W)	Power Input (W)	Capacity (W)	Power Input (W)	Capacity (W)	Power Input (W)	Capacity (W)	Power Input (W)	Capacity (W)	Power Input (W)	Capacity (W)	Power Input (W)	Capacity (W)	Power Input (W)
Outlet Water Temp. ($^{\circ}\text{C}$)	-10	135,090	54,988	132,244	62,443	132,244	71,204	129,406	81,515	113,669	71,414	94,721	69,018	72,854	56,626
	-5	169,111	61,952	169,111	71,865	169,111	81,949	169,111	95,872	148,545	83,992	123,783	81,175	95,207	66,600
	0	198,113	65,394	198,113	75,771	198,113	86,402	198,113	101,083	174,020	88,557	145,012	85,587	111,535	70,220
	5	222,000	58,252	222,000	67,578	222,000	77,154	222,000	90,422	200,850	81,776	166,860	78,977	131,012	66,141
	7	222,000	54,580	222,000	63,486	222,000	72,677	222,000	85,400	201,854	78,013	175,743	79,713	138,393	66,930
	9	222,000	53,437	222,000	61,709	222,000	70,131	222,000	81,654	202,859	74,096	179,529	75,437	143,675	64,176
	11	222,000	52,342	222,000	60,030	222,000	67,757	222,000	78,139	204,867	70,936	183,316	72,569	148,956	62,224
	13	222,000	51,201	222,000	58,467	222,000	65,710	222,000	75,335	210,893	70,002	186,609	70,302	153,549	60,671
	15	222,000	50,082	222,000	56,938	222,000	63,716	222,000	72,624	222,000	79,825	187,103	67,078	156,745	58,722
	20	222,000	48,031	222,000	53,846	222,000	59,445	222,000	66,550	222,000	71,931	187,103	58,233	164,409	54,636

Air-Cooled Scroll Chiller (R410A)

4. Performance Data

■ A(C)CAH067LETB ($\Delta T = 7^{\circ}\text{C}$)

Flow Rate		Outdoor Temperature ($^{\circ}\text{C}$)													
468 LPM		-15		-10		-5		0		5		10		15	
		Capacity (W)	Power Input (W)	Capacity (W)	Power Input (W)	Capacity (W)	Power Input (W)	Capacity (W)	Power Input (W)	Capacity (W)	Power Input (W)	Capacity (W)	Power Input (W)	Capacity (W)	Power Input (W)
Outlet Water Temp. ($^{\circ}\text{C}$)	-10	146,780	40,023	146,780	40,087	146,780	40,346	146,780	40,585	146,780	41,102	146,780	44,286	141,332	48,365
	-5	174,015	42,704	174,015	42,773	174,015	43,049	174,015	43,304	174,015	43,856	174,015	47,253	174,015	53,798
	0	203,858	45,025	203,858	45,097	203,858	45,388	203,858	45,657	203,858	46,239	203,858	49,821	203,858	56,721
	5	228,438	40,008	228,438	40,075	228,438	40,334	228,438	40,575	228,438	41,095	228,438	44,297	228,438	50,474
	7	228,438	37,281	228,438	37,349	228,438	37,590	228,438	37,817	228,438	38,309	228,438	41,334	228,438	47,182
	9	228,438	37,044	228,438	37,104	228,438	37,343	228,438	37,562	228,438	38,032	228,438	40,926	228,438	46,488
	11	228,438	36,802	228,438	36,861	228,438	37,099	228,438	37,309	228,438	37,759	228,438	40,527	228,438	45,815
	13	228,438	36,328	228,438	36,387	228,438	36,621	228,438	36,824	228,438	37,257	228,438	39,921	228,438	44,991
	15	228,438	35,866	228,438	35,924	228,438	36,155	228,438	36,351	228,438	36,768	228,438	39,327	228,438	44,182
	20	228,438	35,458	228,438	35,515	228,438	35,744	228,438	35,923	228,438	36,298	228,438	38,602	228,438	42,921

Flow Rate		Outdoor Temperature ($^{\circ}\text{C}$)													
468 LPM		20		25		30		35		40		45		48	
		Capacity (W)	Power Input (W)	Capacity (W)	Power Input (W)	Capacity (W)	Power Input (W)	Capacity (W)	Power Input (W)	Capacity (W)	Power Input (W)	Capacity (W)	Power Input (W)	Capacity (W)	Power Input (W)
Outlet Water Temp. ($^{\circ}\text{C}$)	-10	139,008	55,263	136,079	62,755	136,079	71,560	133,159	81,922	116,966	71,771	97,468	69,363	74,967	56,910
	-5	174,015	62,262	174,015	72,225	174,015	82,359	174,015	96,352	152,853	84,412	127,373	81,581	97,968	66,933
	0	203,858	65,721	203,858	76,150	203,858	86,835	203,858	101,588	179,067	89,000	149,217	86,015	114,770	70,571
	5	228,438	58,543	228,438	67,916	228,438	77,540	228,438	90,874	206,675	82,185	171,699	79,372	134,812	66,472
	7	228,438	54,853	228,438	63,804	228,438	73,040	228,438	85,928	207,708	78,404	180,839	80,112	142,407	67,265
	9	228,438	53,704	228,438	62,018	228,438	70,481	228,438	82,063	208,741	74,467	184,736	75,814	147,841	64,497
	11	228,438	52,604	228,438	60,330	228,438	68,096	228,438	78,530	210,808	71,290	188,632	72,932	153,276	62,535
	13	228,438	51,457	228,438	58,759	228,438	66,039	228,438	75,712	217,008	70,352	192,020	70,654	158,002	60,975
	15	228,438	50,332	228,438	57,222	228,438	64,035	228,438	72,987	228,438	80,224	192,528	67,413	161,290	59,015
	20	228,438	48,272	228,438	54,115	228,438	59,743	228,438	66,882	228,438	72,291	192,528	58,524	169,177	54,909

Air-Cooled Scroll Chiller (R410A)

4. Performance Data

■ A(C)CAH067LETB ($\Delta T = 10^{\circ}\text{C}$)

Flow Rate		Outdoor Temperature ($^{\circ}\text{C}$)													
		-15		-10		-5		0		5		10		15	
341 LPM		Capacity (W)	Power Input (W)	Capacity (W)	Power Input (W)	Capacity (W)	Power Input (W)	Capacity (W)	Power Input (W)	Capacity (W)	Power Input (W)	Capacity (W)	Power Input (W)	Capacity (W)	Power Input (W)
Outlet Water Temp. ($^{\circ}\text{C}$)	-10	152,914	40,342	152,914	40,406	152,914	40,667	152,914	40,908	152,914	41,430	152,914	44,638	147,238	48,750
	-5	181,287	43,044	181,287	43,113	181,287	43,391	181,287	43,649	181,287	44,205	181,287	47,629	181,287	54,226
	0	212,377	45,383	212,377	45,456	212,377	45,749	212,377	46,021	212,377	46,607	212,377	50,217	212,377	57,173
	5	237,984	40,327	237,984	40,394	237,984	40,655	237,984	40,898	237,984	41,422	237,984	44,650	237,984	50,876
	7	237,984	37,578	237,984	37,646	237,984	37,890	237,984	38,118	237,984	38,613	237,984	41,663	237,984	47,558
	9	237,984	37,339	237,984	37,399	237,984	37,640	237,984	37,861	237,984	38,335	237,984	41,252	237,984	46,858
	11	237,984	37,095	237,984	37,155	237,984	37,394	237,984	37,606	237,984	38,060	237,984	40,849	237,984	46,179
	13	237,984	36,618	237,984	36,676	237,984	36,913	237,984	37,118	237,984	37,554	237,984	40,239	237,984	45,349
	15	237,984	36,152	237,984	36,210	237,984	36,443	237,984	36,641	237,984	37,060	237,984	39,640	237,984	44,534
	20	237,984	35,740	237,984	35,798	237,984	36,029	237,984	36,209	237,984	36,586	237,984	38,910	237,984	43,262

Flow Rate		Outdoor Temperature ($^{\circ}\text{C}$)													
		20		25		30		35		40		45		48	
341 LPM		Capacity (W)	Power Input (W)	Capacity (W)	Power Input (W)	Capacity (W)	Power Input (W)	Capacity (W)	Power Input (W)	Capacity (W)	Power Input (W)	Capacity (W)	Power Input (W)	Capacity (W)	Power Input (W)
Outlet Water Temp. ($^{\circ}\text{C}$)	-10	144,817	55,702	141,765	63,254	141,765	72,130	138,724	82,574	121,853	72,342	101,541	69,916	78,100	57,363
	-5	181,287	62,757	181,287	72,800	181,287	83,014	181,287	97,119	159,240	85,084	132,696	82,230	102,062	67,466
	0	212,377	66,244	212,377	76,756	212,377	87,526	212,377	102,397	186,549	89,708	155,453	86,699	119,566	71,133
	5	237,984	59,009	237,984	68,456	237,984	78,157	237,984	91,597	215,311	82,839	178,874	80,004	140,445	67,001
	7	237,984	55,290	237,984	64,312	237,984	73,621	237,984	86,612	216,388	79,028	188,396	80,749	148,358	67,800
	9	237,984	54,132	237,984	62,511	237,984	71,042	237,984	82,716	217,464	75,059	192,455	76,418	154,019	65,010
	11	237,984	53,023	237,984	60,811	237,984	68,638	237,984	79,155	219,617	71,858	196,515	73,512	159,681	63,033
	13	237,984	51,867	237,984	59,227	237,984	66,564	237,984	76,314	226,077	70,912	200,044	71,216	164,604	61,460
	15	237,984	50,733	237,984	57,678	237,984	64,545	237,984	73,568	237,984	80,863	200,574	67,950	168,030	59,485
	20	237,984	48,656	237,984	54,546	237,984	60,218	237,984	67,415	237,984	72,866	200,574	58,990	176,246	55,346

Air-Cooled Scroll Chiller (R410A)

4. Performance Data

■ 460V

■ ACAH020HETB ($\Delta T = 5^{\circ}\text{C}$)

Flow Rate		Outdoor Temperature ($^{\circ}\text{C}$)													
		-15		-10		-5		0		5		10		15	
186 LPM		Capacity (W)	Power Input (W)	Capacity (W)	Power Input (W)	Capacity (W)	Power Input (W)	Capacity (W)	Power Input (W)	Capacity (W)	Power Input (W)	Capacity (W)	Power Input (W)	Capacity (W)	Power Input (W)
Outlet Water Temp. ($^{\circ}\text{C}$)	-10	44,000	10,561	44,000	10,578	44,000	10,647	44,000	10,710	44,000	10,846	44,000	11,686	42,367	12,763
	-5	52,164	11,269	52,164	11,287	52,164	11,360	52,164	11,427	52,164	11,573	52,164	12,469	52,164	14,196
	0	61,110	11,881	61,110	11,900	61,110	11,977	61,110	12,048	61,110	12,202	61,110	13,147	61,110	14,968
	5	65,000	10,021	65,000	10,038	65,000	10,103	65,000	10,163	65,000	10,293	65,000	11,095	65,000	12,643
	7	65,000	9,338	65,000	9,355	65,000	9,416	65,000	9,472	65,000	9,595	65,000	10,353	65,000	11,818
	9	65,000	9,279	65,000	9,294	65,000	9,354	65,000	9,408	65,000	9,526	65,000	10,251	65,000	11,644
	11	65,000	9,218	65,000	9,233	65,000	9,293	65,000	9,345	65,000	9,458	65,000	10,151	65,000	11,476
	13	65,000	9,099	65,000	9,114	65,000	9,173	65,000	9,224	65,000	9,332	65,000	9,999	65,000	11,269
	15	65,000	8,984	65,000	8,998	65,000	9,056	65,000	9,105	65,000	9,210	65,000	9,851	65,000	11,067
	20	65,000	8,882	65,000	8,896	65,000	8,953	65,000	8,998	65,000	9,092	65,000	9,669	65,000	10,751

Flow Rate		Outdoor Temperature ($^{\circ}\text{C}$)													
		20		25		30		35		40		45		48	
186 LPM		Capacity (W)	Power Input (W)	Capacity (W)	Power Input (W)	Capacity (W)	Power Input (W)	Capacity (W)	Power Input (W)	Capacity (W)	Power Input (W)	Capacity (W)	Power Input (W)	Capacity (W)	Power Input (W)
Outlet Water Temp. ($^{\circ}\text{C}$)	-10	39,553	13,842	38,720	15,719	38,720	17,924	37,889	20,520	36,247	22,707	31,163	22,707	24,164	18,782
	-5	51,689	16,280	50,600	18,487	50,600	21,081	46,586	22,707	40,275	22,707	34,625	22,707	31,578	22,090
	0	61,110	17,342	61,110	20,095	60,556	22,707	51,762	22,707	44,750	22,707	38,472	22,707	36,066	22,707
	5	65,000	14,664	65,000	17,011	65,000	19,422	64,842	22,707	55,932	22,707	47,973	22,707	43,454	21,937
	7	65,000	13,740	65,000	15,981	65,000	18,295	65,000	21,523	58,923	22,707	50,061	22,707	45,902	22,199
	9	65,000	13,452	65,000	15,534	65,000	17,654	65,000	20,555	62,346	22,707	54,038	22,707	47,653	21,286
	11	65,000	13,176	65,000	15,111	65,000	17,056	65,000	19,670	65,000	22,441	57,359	22,707	49,405	20,638
	13	65,000	12,889	65,000	14,718	65,000	16,541	65,000	18,964	65,000	21,513	60,272	22,707	50,928	20,123
	15	65,000	12,607	65,000	14,333	65,000	16,039	65,000	18,282	65,000	20,623	61,750	22,138	51,988	19,477
	20	65,000	12,091	65,000	13,555	65,000	14,964	65,000	16,753	65,000	18,584	61,750	19,219	54,530	18,121

Air-Cooled Scroll Chiller (R410A)

4. Performance Data

■ ACAH020HETB ($\Delta T = 7^{\circ}\text{C}$)

Flow Rate		Outdoor Temperature ($^{\circ}\text{C}$)													
		-15		-10		-5		0		5		10		15	
137 LPM		Capacity (W)	Power Input (W)	Capacity (W)	Power Input (W)	Capacity (W)	Power Input (W)	Capacity (W)	Power Input (W)	Capacity (W)	Power Input (W)	Capacity (W)	Power Input (W)	Capacity (W)	Power Input (W)
Outlet Water Temp. ($^{\circ}\text{C}$)	-10	45,276	10,614	45,276	10,631	45,276	10,700	45,276	10,763	45,276	10,900	45,276	11,745	43,595	12,826
	-5	53,677	11,325	53,677	11,343	53,677	11,417	53,677	11,484	53,677	11,631	53,677	12,531	53,677	14,267
	0	62,882	11,941	62,882	11,960	62,882	12,037	62,882	12,108	62,882	12,263	62,882	13,212	62,882	15,043
	5	66,885	10,071	66,885	10,088	66,885	10,153	66,885	10,214	66,885	10,345	66,885	11,151	66,885	12,706
	7	66,885	9,385	66,885	9,402	66,885	9,463	66,885	9,520	66,885	9,643	66,885	10,405	66,885	11,877
	9	66,885	9,325	66,885	9,340	66,885	9,400	66,885	9,455	66,885	9,574	66,885	10,302	66,885	11,702
	11	66,885	9,264	66,885	9,279	66,885	9,339	66,885	9,392	66,885	9,505	66,885	10,202	66,885	11,533
	13	66,885	9,145	66,885	9,160	66,885	9,219	66,885	9,270	66,885	9,379	66,885	10,049	66,885	11,326
	15	66,885	9,029	66,885	9,043	66,885	9,101	66,885	9,151	66,885	9,256	66,885	9,900	66,885	11,122
	20	66,885	8,926	66,885	8,940	66,885	8,998	66,885	9,043	66,885	9,137	66,885	9,717	66,885	10,804

Flow Rate		Outdoor Temperature ($^{\circ}\text{C}$)													
		20		25		30		35		40		45		48	
137 LPM		Capacity (W)	Power Input (W)	Capacity (W)	Power Input (W)	Capacity (W)	Power Input (W)	Capacity (W)	Power Input (W)	Capacity (W)	Power Input (W)	Capacity (W)	Power Input (W)	Capacity (W)	Power Input (W)
Outlet Water Temp. ($^{\circ}\text{C}$)	-10	40,701	13,911	39,843	15,797	39,843	18,014	38,988	20,622	37,113	22,707	31,907	22,707	24,865	18,875
	-5	53,188	16,362	52,067	18,580	52,067	21,187	47,698	22,707	41,236	22,707	35,452	22,707	32,494	22,200
	0	62,882	17,429	62,882	20,195	62,003	22,707	52,998	22,707	45,818	22,707	39,391	22,707	36,928	22,707
	5	66,885	14,737	66,885	17,097	66,885	19,519	66,390	22,707	57,268	22,707	49,119	22,707	44,714	22,047
	7	66,885	13,808	66,885	16,061	66,885	18,386	66,885	21,631	60,330	22,707	51,256	22,707	47,233	22,310
	9	66,885	13,519	66,885	15,612	66,885	17,742	66,885	20,658	63,835	22,707	55,329	22,707	49,035	21,392
	11	66,885	13,242	66,885	15,187	66,885	17,142	66,885	19,768	66,885	22,553	58,728	22,707	50,838	20,741
	13	66,885	12,953	66,885	14,792	66,885	16,624	66,885	19,059	66,885	21,621	61,711	22,707	52,405	20,224
	15	66,885	12,670	66,885	14,405	66,885	16,120	66,885	18,373	66,885	20,726	63,541	22,249	53,496	19,574
	20	66,885	12,151	66,885	13,622	66,885	15,039	66,885	16,836	66,885	18,677	63,541	19,315	56,112	18,212

Air-Cooled Scroll Chiller (R410A)

4. Performance Data

■ ACAH020HETB ($\Delta T = 10^{\circ}\text{C}$)

Flow Rate		Outdoor Temperature ($^{\circ}\text{C}$)													
		-15		-10		-5		0		5		10		15	
100 LPM		Capacity (W)	Power Input (W)	Capacity (W)	Power Input (W)	Capacity (W)	Power Input (W)	Capacity (W)	Power Input (W)	Capacity (W)	Power Input (W)	Capacity (W)	Power Input (W)	Capacity (W)	Power Input (W)
Outlet Water Temp. ($^{\circ}\text{C}$)	-10	47,168	10,699	47,168	10,716	47,168	10,785	47,168	10,849	47,168	10,987	47,168	11,838	45,417	12,929
	-5	55,920	11,415	55,920	11,434	55,920	11,507	55,920	11,576	55,920	11,723	55,920	12,631	55,920	14,381
	0	65,510	12,036	65,510	12,055	65,510	12,133	65,510	12,205	65,510	12,360	65,510	13,318	65,510	15,162
	5	69,680	10,152	69,680	10,168	69,680	10,234	69,680	10,295	69,680	10,427	69,680	11,240	69,680	12,807
	7	69,680	9,459	69,680	9,477	69,680	9,538	69,680	9,596	69,680	9,720	69,680	10,488	69,680	11,972
	9	69,680	9,399	69,680	9,415	69,680	9,475	69,680	9,531	69,680	9,650	69,680	10,384	69,680	11,796
	11	69,680	9,338	69,680	9,353	69,680	9,413	69,680	9,467	69,680	9,581	69,680	10,283	69,680	11,625
	13	69,680	9,218	69,680	9,233	69,680	9,292	69,680	9,344	69,680	9,454	69,680	10,129	69,680	11,416
	15	69,680	9,100	69,680	9,115	69,680	9,174	69,680	9,224	69,680	9,329	69,680	9,979	69,680	11,211
	20	69,680	8,997	69,680	9,011	69,680	9,070	69,680	9,115	69,680	9,210	69,680	9,795	69,680	10,891

Flow Rate		Outdoor Temperature ($^{\circ}\text{C}$)													
		20		25		30		35		40		45		48	
100 LPM		Capacity (W)	Power Input (W)	Capacity (W)	Power Input (W)	Capacity (W)	Power Input (W)	Capacity (W)	Power Input (W)	Capacity (W)	Power Input (W)	Capacity (W)	Power Input (W)	Capacity (W)	Power Input (W)
Outlet Water Temp. ($^{\circ}\text{C}$)	-10	42,401	14,022	41,508	15,923	41,508	18,157	40,617	20,787	38,358	22,707	32,978	22,707	25,904	19,026
	-5	55,411	16,492	54,243	18,728	54,243	21,355	49,299	22,707	42,620	22,707	36,642	22,707	33,851	22,377
	0	65,510	17,568	65,510	20,356	64,083	22,707	54,777	22,707	47,356	22,707	40,713	22,707	38,167	22,707
	5	69,680	14,855	69,680	17,233	69,680	19,675	68,618	22,707	59,190	22,707	50,767	22,707	46,582	22,223
	7	69,680	13,918	69,680	16,189	69,680	18,533	69,680	21,803	62,354	22,707	52,976	22,707	49,207	22,488
	9	69,680	13,627	69,680	15,736	69,680	17,884	69,680	20,822	65,978	22,707	57,186	22,707	51,084	21,562
	11	69,680	13,347	69,680	15,308	69,680	17,278	69,680	19,926	69,599	22,707	60,699	22,707	52,962	20,906
	13	69,680	13,056	69,680	14,909	69,680	16,756	69,680	19,211	69,680	21,793	63,782	22,707	54,595	20,385
	15	69,680	12,771	69,680	14,519	69,680	16,248	69,680	18,519	69,680	20,891	66,196	22,426	55,731	19,730
	20	69,680	12,248	69,680	13,731	69,680	15,159	69,680	16,970	69,680	18,825	66,196	19,469	58,457	18,357

Air-Cooled Scroll Chiller (R410A)

4. Performance Data

■ ACAH023HETB ($\Delta T = 5^{\circ}\text{C}$)

Flow Rate		Outdoor Temperature ($^{\circ}\text{C}$)													
		-15		-10		-5		0		5		10		15	
211 LPM		Capacity (W)	Power Input (W)	Capacity (W)	Power Input (W)	Capacity (W)	Power Input (W)	Capacity (W)	Power Input (W)	Capacity (W)	Power Input (W)	Capacity (W)	Power Input (W)	Capacity (W)	Power Input (W)
Outlet Water Temp. ($^{\circ}\text{C}$)	-10	47,548	13,275	47,548	13,296	47,548	13,382	47,548	13,461	47,548	13,633	47,548	14,688	45,783	16,041
	-5	56,370	14,164	56,370	14,187	56,370	14,278	56,370	14,363	56,370	14,546	56,370	15,672	56,370	17,843
	0	66,038	14,934	66,038	14,958	66,038	15,054	66,038	15,143	66,038	15,336	66,038	16,524	66,038	18,813
	5	74,000	13,270	74,000	13,292	74,000	13,378	74,000	13,458	74,000	13,630	74,000	14,692	74,000	16,741
	7	74,000	12,365	74,000	12,388	74,000	12,468	74,000	12,543	74,000	12,706	74,000	13,709	74,000	15,649
	9	74,000	12,287	74,000	12,306	74,000	12,386	74,000	12,458	74,000	12,614	74,000	13,574	74,000	15,419
	11	74,000	12,206	74,000	12,226	74,000	12,305	74,000	12,375	74,000	12,524	74,000	13,442	74,000	15,196
	13	74,000	12,049	74,000	12,069	74,000	12,146	74,000	12,214	74,000	12,357	74,000	13,241	74,000	14,922
	15	74,000	11,896	74,000	11,915	74,000	11,992	74,000	12,057	74,000	12,195	74,000	13,044	74,000	14,654
	20	74,000	11,761	74,000	11,779	74,000	11,855	74,000	11,915	74,000	12,039	74,000	12,803	74,000	14,236

Flow Rate		Outdoor Temperature ($^{\circ}\text{C}$)													
		20		25		30		35		40		45		48	
211 LPM		Capacity (W)	Power Input (W)	Capacity (W)	Power Input (W)	Capacity (W)	Power Input (W)	Capacity (W)	Power Input (W)	Capacity (W)	Power Input (W)	Capacity (W)	Power Input (W)	Capacity (W)	Power Input (W)
Outlet Water Temp. ($^{\circ}\text{C}$)	-10	45,030	18,329	44,081	20,814	44,081	23,735	43,135	27,172	37,890	23,805	31,574	23,006	24,285	18,875
	-5	56,370	20,651	56,370	23,955	56,370	27,316	50,733	28,762	49,515	27,997	41,261	27,058	31,736	22,200
	0	66,038	21,798	66,038	25,257	65,948	28,762	56,370	28,762	56,518	28,762	48,337	28,529	37,178	23,407
	5	74,000	19,417	74,000	22,526	74,000	25,718	70,614	28,762	66,950	27,259	55,620	26,326	43,671	22,047
	7	74,000	18,193	74,000	21,162	74,000	24,226	74,000	28,450	67,285	26,004	58,581	26,571	46,131	22,310
	9	74,000	17,812	74,000	20,570	74,000	23,377	74,000	27,218	67,620	24,699	59,843	25,146	47,892	21,392
	11	74,000	17,447	74,000	20,010	74,000	22,586	74,000	26,046	68,289	23,645	61,105	24,190	49,652	20,741
	13	74,000	17,067	74,000	19,489	74,000	21,903	74,000	25,112	70,298	23,334	62,203	23,434	51,183	20,224
	15	74,000	16,694	74,000	18,979	74,000	21,239	74,000	24,208	74,000	26,608	62,368	22,359	52,248	19,574
	20	74,000	16,010	74,000	17,949	74,000	19,815	74,000	22,183	74,000	23,977	62,368	19,411	54,803	18,212

Air-Cooled Scroll Chiller (R410A)

4. Performance Data

■ ACAH023HETB ($\Delta T = 7^{\circ}\text{C}$)

Flow Rate		Outdoor Temperature ($^{\circ}\text{C}$)													
		-15		-10		-5		0		5		10		15	
156 LPM		Capacity (W)	Power Input (W)	Capacity (W)	Power Input (W)	Capacity (W)	Power Input (W)	Capacity (W)	Power Input (W)	Capacity (W)	Power Input (W)	Capacity (W)	Power Input (W)	Capacity (W)	Power Input (W)
Outlet Water Temp. ($^{\circ}\text{C}$)	-10	48,927	13,341	48,927	13,362	48,927	13,449	48,927	13,528	48,927	13,701	48,927	14,762	47,111	16,122
	-5	58,005	14,235	58,005	14,258	58,005	14,350	58,005	14,435	58,005	14,619	58,005	15,751	58,005	17,933
	0	67,953	15,008	67,953	15,032	67,953	15,129	67,953	15,219	67,953	15,413	67,953	16,607	67,953	18,907
	5	76,146	13,336	76,146	13,358	76,146	13,445	76,146	13,525	76,146	13,698	76,146	14,766	76,146	16,825
	7	76,146	12,427	76,146	12,450	76,146	12,530	76,146	12,606	76,146	12,770	76,146	13,778	76,146	15,727
	9	76,146	12,348	76,146	12,368	76,146	12,448	76,146	12,521	76,146	12,677	76,146	13,642	76,146	15,496
	11	76,146	12,267	76,146	12,287	76,146	12,366	76,146	12,436	76,146	12,586	76,146	13,509	76,146	15,272
	13	76,146	12,109	76,146	12,129	76,146	12,207	76,146	12,275	76,146	12,419	76,146	13,307	76,146	14,997
	15	76,146	11,955	76,146	11,975	76,146	12,052	76,146	12,117	76,146	12,256	76,146	13,109	76,146	14,727
	20	76,146	11,819	76,146	11,838	76,146	11,915	76,146	11,974	76,146	12,099	76,146	12,867	76,146	14,307

Flow Rate		Outdoor Temperature ($^{\circ}\text{C}$)													
		20		25		30		35		40		45		48	
156 LPM		Capacity (W)	Power Input (W)	Capacity (W)	Power Input (W)	Capacity (W)	Power Input (W)	Capacity (W)	Power Input (W)	Capacity (W)	Power Input (W)	Capacity (W)	Power Input (W)	Capacity (W)	Power Input (W)
Outlet Water Temp. ($^{\circ}\text{C}$)	-10	46,336	18,421	45,360	20,918	45,360	23,853	44,386	27,307	38,989	23,924	32,489	23,121	24,989	18,970
	-5	58,005	20,754	58,005	24,075	58,005	27,453	51,945	28,762	50,951	28,137	42,458	27,194	32,656	22,311
	0	67,953	21,907	67,953	25,383	67,522	28,762	57,716	28,762	57,868	28,762	49,739	28,672	38,257	23,524
	5	76,146	19,514	76,146	22,639	76,146	25,847	72,301	28,762	68,892	27,395	57,233	26,457	44,937	22,157
	7	76,146	18,284	76,146	21,268	76,146	24,347	76,146	28,592	69,236	26,135	60,280	26,704	47,469	22,422
	9	76,146	17,901	76,146	20,673	76,146	23,494	76,146	27,354	69,580	24,822	61,579	25,271	49,280	21,499
	11	76,146	17,535	76,146	20,110	76,146	22,699	76,146	26,177	70,269	23,763	62,877	24,311	51,092	20,845
	13	76,146	17,152	76,146	19,586	76,146	22,013	76,146	25,237	72,336	23,451	64,007	23,551	52,667	20,325
	15	76,146	16,777	76,146	19,074	76,146	21,345	76,146	24,329	76,146	26,741	64,176	22,471	53,763	19,672
	20	76,146	16,091	76,146	18,038	76,146	19,914	76,146	22,294	76,146	24,097	64,176	19,508	56,392	18,303

Air-Cooled Scroll Chiller (R410A)

4. Performance Data

■ ACAH023HETB ($\Delta T = 10^{\circ}\text{C}$)

Flow Rate		Outdoor Temperature ($^{\circ}\text{C}$)													
		-15		-10		-5		0		5		10		15	
114 LPM		Capacity (W)	Power Input (W)	Capacity (W)	Power Input (W)	Capacity (W)	Power Input (W)	Capacity (W)	Power Input (W)	Capacity (W)	Power Input (W)	Capacity (W)	Power Input (W)	Capacity (W)	Power Input (W)
Outlet Water Temp. ($^{\circ}\text{C}$)	-10	50,971	13,447	50,971	13,469	50,971	13,556	50,971	13,636	50,971	13,810	50,971	14,879	49,079	16,250
	-5	60,429	14,348	60,429	14,371	60,429	14,464	60,429	14,550	60,429	14,735	60,429	15,876	60,429	18,075
	0	70,792	15,128	70,792	15,152	70,792	15,250	70,792	15,340	70,792	15,536	70,792	16,739	70,792	19,058
	5	79,328	13,442	79,328	13,465	79,328	13,552	79,328	13,633	79,328	13,807	79,328	14,883	79,328	16,959
	7	79,328	12,526	79,328	12,549	79,328	12,630	79,328	12,706	79,328	12,871	79,328	13,888	79,328	15,853
	9	79,328	12,446	79,328	12,466	79,328	12,547	79,328	12,620	79,328	12,778	79,328	13,751	79,328	15,619
	11	79,328	12,365	79,328	12,385	79,328	12,465	79,328	12,535	79,328	12,687	79,328	13,616	79,328	15,393
	13	79,328	12,206	79,328	12,225	79,328	12,304	79,328	12,373	79,328	12,518	79,328	13,413	79,328	15,116
	15	79,328	12,051	79,328	12,070	79,328	12,148	79,328	12,214	79,328	12,353	79,328	13,213	79,328	14,845
	20	79,328	11,913	79,328	11,933	79,328	12,010	79,328	12,070	79,328	12,195	79,328	12,970	79,328	14,421

Flow Rate		Outdoor Temperature ($^{\circ}\text{C}$)													
		20		25		30		35		40		45		48	
114 LPM		Capacity (W)	Power Input (W)	Capacity (W)	Power Input (W)	Capacity (W)	Power Input (W)	Capacity (W)	Power Input (W)	Capacity (W)	Power Input (W)	Capacity (W)	Power Input (W)	Capacity (W)	Power Input (W)
Outlet Water Temp. ($^{\circ}\text{C}$)	-10	48,272	18,567	47,255	21,085	47,255	24,043	46,241	27,525	40,618	24,114	33,847	23,305	26,033	19,121
	-5	60,429	20,919	60,429	24,267	60,429	27,671	53,688	28,762	53,080	28,361	44,232	27,410	34,021	22,489
	0	70,792	22,081	70,792	25,585	69,789	28,762	59,653	28,762	59,810	28,762	51,570	28,762	39,855	23,711
	5	79,328	19,670	79,328	22,819	79,328	26,052	74,727	28,762	71,770	27,613	59,625	26,668	46,815	22,334
	7	79,328	18,430	79,328	21,437	79,328	24,540	79,167	28,762	72,129	26,343	62,799	26,916	49,453	22,600
	9	79,328	18,044	79,328	20,837	79,328	23,681	79,328	27,572	72,488	25,020	64,152	25,473	51,340	21,670
	11	79,328	17,674	79,328	20,270	79,328	22,879	79,328	26,385	73,206	23,953	65,505	24,504	53,227	21,011
	13	79,328	17,289	79,328	19,742	79,328	22,188	79,328	25,438	75,359	23,637	66,681	23,739	54,868	20,487
	15	79,328	16,911	79,328	19,226	79,328	21,515	79,328	24,523	79,328	26,954	66,858	22,650	56,010	19,828
	20	79,328	16,219	79,328	18,182	79,328	20,073	79,328	22,472	79,328	24,289	66,858	19,663	58,749	18,449

Air-Cooled Scroll Chiller (R410A)

4. Performance Data

■ ACAH033HETB ($\Delta T = 5^{\circ}\text{C}$)

Flow Rate		Outdoor Temperature ($^{\circ}\text{C}$)													
		-15		-10		-5		0		5		10		15	
327 LPM		Capacity (W)	Power Input (W)	Capacity (W)	Power Input (W)	Capacity (W)	Power Input (W)	Capacity (W)	Power Input (W)	Capacity (W)	Power Input (W)	Capacity (W)	Power Input (W)	Capacity (W)	Power Input (W)
Outlet Water Temp. ($^{\circ}\text{C}$)	-10	86,240	21,123	86,240	21,157	86,240	21,293	86,240	21,419	86,240	21,692	86,240	23,372	83,039	25,525
	-5	103,230	22,392	103,230	22,427	103,230	22,572	103,230	22,706	103,230	22,995	103,230	24,776	103,230	28,208
	0	114,000	21,513	114,000	21,548	114,000	21,686	114,000	21,815	114,000	22,093	114,000	23,804	114,000	27,102
	5	114,000	16,851	114,000	16,879	114,000	16,988	114,000	17,090	114,000	17,309	114,000	18,658	114,000	21,259
	7	114,000	15,702	114,000	15,731	114,000	15,833	114,000	15,928	114,000	16,135	114,000	17,409	114,000	19,873
	9	114,000	15,603	114,000	15,628	114,000	15,729	114,000	15,821	114,000	16,019	114,000	17,238	114,000	19,580
	11	114,000	15,501	114,000	15,526	114,000	15,626	114,000	15,714	114,000	15,904	114,000	17,069	114,000	19,297
	13	114,000	15,301	114,000	15,326	114,000	15,425	114,000	15,510	114,000	15,692	114,000	16,814	114,000	18,950
	15	114,000	15,106	114,000	15,131	114,000	15,228	114,000	15,311	114,000	15,486	114,000	16,564	114,000	18,609
	20	114,000	14,935	114,000	14,959	114,000	15,055	114,000	15,131	114,000	15,288	114,000	16,259	114,000	18,078

Flow Rate		Outdoor Temperature ($^{\circ}\text{C}$)													
		20		25		30		35		40		45		48	
327 LPM		Capacity (W)	Power Input (W)	Capacity (W)	Power Input (W)	Capacity (W)	Power Input (W)	Capacity (W)	Power Input (W)	Capacity (W)	Power Input (W)	Capacity (W)	Power Input (W)	Capacity (W)	Power Input (W)
Outlet Water Temp. ($^{\circ}\text{C}$)	-10	77,525	27,684	75,891	31,437	75,891	35,848	65,742	36,330	56,836	36,330	49,860	36,330	46,742	36,330
	-5	102,327	32,538	97,448	36,330	85,457	36,330	73,046	36,330	63,151	36,330	55,400	36,330	51,935	36,330
	0	114,000	31,401	113,831	36,330	99,824	36,330	84,273	36,330	72,019	36,330	61,556	36,330	57,706	36,330
	5	114,000	24,658	114,000	28,605	114,000	32,659	108,208	36,330	93,339	36,330	76,757	36,330	71,963	36,330
	7	114,000	23,104	114,000	26,873	114,000	30,764	114,000	36,192	98,330	36,330	80,097	36,330	75,122	36,330
	9	114,000	22,620	114,000	26,121	114,000	29,686	114,000	34,564	104,044	36,330	86,461	36,330	81,335	36,330
	11	114,000	22,156	114,000	25,411	114,000	28,681	114,000	33,076	109,755	36,330	92,893	36,330	86,970	36,330
	13	114,000	21,673	114,000	24,749	114,000	27,815	114,000	31,889	114,000	36,175	98,333	36,330	91,946	36,330
	15	114,000	21,199	114,000	24,101	114,000	26,971	114,000	30,741	114,000	34,679	103,470	36,330	96,976	36,330
	20	114,000	20,332	114,000	22,793	114,000	25,163	114,000	28,170	114,000	31,249	114,000	34,750	107,970	35,880

Air-Cooled Scroll Chiller (R410A)

4. Performance Data

■ ACAH033HETB ($\Delta T = 7^{\circ}\text{C}$)

Flow Rate		Outdoor Temperature ($^{\circ}\text{C}$)													
		-15		-10		-5		0		5		10		15	
240 LPM		Capacity (W)	Power Input (W)	Capacity (W)	Power Input (W)	Capacity (W)	Power Input (W)	Capacity (W)	Power Input (W)	Capacity (W)	Power Input (W)	Capacity (W)	Power Input (W)	Capacity (W)	Power Input (W)
Outlet Water Temp. ($^{\circ}\text{C}$)	-10	88,741	21,228	88,741	21,262	88,741	21,399	88,741	21,526	88,741	21,801	88,741	23,489	85,447	25,653
	-5	106,224	22,503	106,224	22,540	106,224	22,685	106,224	22,820	106,224	23,110	106,224	24,900	106,224	28,349
	0	117,306	21,621	117,306	21,655	117,306	21,795	117,306	21,924	117,306	22,204	117,306	23,923	117,306	27,237
	5	117,306	16,935	117,306	16,964	117,306	17,073	117,306	17,175	117,306	17,395	117,306	18,751	117,306	21,365
	7	117,306	15,781	117,306	15,810	117,306	15,912	117,306	16,008	117,306	16,216	117,306	17,497	117,306	19,972
	9	117,306	15,681	117,306	15,706	117,306	15,807	117,306	15,900	117,306	16,099	117,306	17,324	117,306	19,678
	11	117,306	15,578	117,306	15,603	117,306	15,704	117,306	15,793	117,306	15,983	117,306	17,155	117,306	19,393
	13	117,306	15,378	117,306	15,402	117,306	15,502	117,306	15,588	117,306	15,771	117,306	16,898	117,306	19,044
	15	117,306	15,182	117,306	15,206	117,306	15,304	117,306	15,387	117,306	15,564	117,306	16,647	117,306	18,702
	20	117,306	15,009	117,306	15,033	117,306	15,130	117,306	15,206	117,306	15,365	117,306	16,340	117,306	18,168

Flow Rate		Outdoor Temperature ($^{\circ}\text{C}$)													
		20		25		30		35		40		45		48	
240 LPM		Capacity (W)	Power Input (W)	Capacity (W)	Power Input (W)	Capacity (W)	Power Input (W)	Capacity (W)	Power Input (W)	Capacity (W)	Power Input (W)	Capacity (W)	Power Input (W)	Capacity (W)	Power Input (W)
Outlet Water Temp. ($^{\circ}\text{C}$)	-10	79,773	27,823	78,092	31,595	78,092	36,028	67,312	36,330	58,193	36,330	51,051	36,330	47,858	36,330
	-5	105,294	32,701	99,775	36,330	87,498	36,330	74,791	36,330	64,659	36,330	56,723	36,330	53,176	36,330
	0	117,306	31,558	116,549	36,330	102,208	36,330	86,286	36,330	73,739	36,330	63,026	36,330	59,084	36,330
	5	117,306	24,781	117,306	28,748	117,306	32,822	110,792	36,330	95,568	36,330	78,590	36,330	73,682	36,330
	7	117,306	23,219	117,306	27,008	117,306	30,917	117,169	36,330	100,678	36,330	82,010	36,330	76,915	36,330
	9	117,306	22,733	117,306	26,252	117,306	29,834	117,306	34,737	106,528	36,330	88,526	36,330	83,278	36,330
	11	117,306	22,267	117,306	25,538	117,306	28,825	117,306	33,241	112,376	36,330	95,112	36,330	89,047	36,330
	13	117,306	21,782	117,306	24,873	117,306	27,954	117,306	32,048	117,224	36,330	100,681	36,330	94,142	36,330
	15	117,306	21,305	117,306	24,222	117,306	27,106	117,306	30,895	117,306	34,852	105,941	36,330	99,292	36,330
	20	117,306	20,433	117,306	22,907	117,306	25,289	117,306	28,311	117,306	31,406	117,306	34,923	111,101	36,060

Air-Cooled Scroll Chiller (R410A)

4. Performance Data

■ ACAH033HETB ($\Delta T = 10^{\circ}\text{C}$)

Flow Rate		Outdoor Temperature ($^{\circ}\text{C}$)													
		-15		-10		-5		0		5		10		15	
175 LPM		Capacity (W)	Power Input (W)	Capacity (W)	Power Input (W)	Capacity (W)	Power Input (W)	Capacity (W)	Power Input (W)	Capacity (W)	Power Input (W)	Capacity (W)	Power Input (W)	Capacity (W)	Power Input (W)
Outlet Water Temp. ($^{\circ}\text{C}$)	-10	92,449	21,397	92,449	21,432	92,449	21,570	92,449	21,698	92,449	21,974	92,449	23,676	89,018	25,857
	-5	110,663	22,683	110,663	22,719	110,663	22,865	110,663	23,001	110,663	23,294	110,663	25,098	110,663	28,575
	0	122,208	21,793	122,208	21,828	122,208	21,968	122,208	22,099	122,208	22,380	122,208	24,114	122,208	27,454
	5	122,208	17,070	122,208	17,099	122,208	17,209	122,208	17,312	122,208	17,534	122,208	18,900	122,208	21,535
	7	122,208	15,906	122,208	15,935	122,208	16,039	122,208	16,135	122,208	16,345	122,208	17,636	122,208	20,131
	9	122,208	15,806	122,208	15,831	122,208	15,933	122,208	16,026	122,208	16,227	122,208	17,462	122,208	19,835
	11	122,208	15,702	122,208	15,727	122,208	15,829	122,208	15,919	122,208	16,111	122,208	17,291	122,208	19,547
	13	122,208	15,500	122,208	15,525	122,208	15,625	122,208	15,712	122,208	15,896	122,208	17,033	122,208	19,196
	15	122,208	15,303	122,208	15,327	122,208	15,426	122,208	15,510	122,208	15,687	122,208	16,780	122,208	18,851
	20	122,208	15,129	122,208	15,153	122,208	15,251	122,208	15,327	122,208	15,487	122,208	16,470	122,208	18,313

Flow Rate		Outdoor Temperature ($^{\circ}\text{C}$)													
		20		25		30		35		40		45		48	
175 LPM		Capacity (W)	Power Input (W)	Capacity (W)	Power Input (W)	Capacity (W)	Power Input (W)	Capacity (W)	Power Input (W)	Capacity (W)	Power Input (W)	Capacity (W)	Power Input (W)	Capacity (W)	Power Input (W)
Outlet Water Temp. ($^{\circ}\text{C}$)	-10	83,107	28,044	81,355	31,846	81,355	36,314	69,571	36,330	60,146	36,330	52,764	36,330	49,464	36,330
	-5	109,694	32,961	103,124	36,330	90,435	36,330	77,301	36,330	66,829	36,330	58,627	36,330	54,960	36,330
	0	122,208	31,810	120,461	36,330	105,638	36,330	89,182	36,330	76,213	36,330	65,141	36,330	61,067	36,330
	5	122,208	24,978	122,208	28,977	122,208	33,084	114,510	36,330	98,776	36,330	81,228	36,330	76,155	36,330
	7	122,208	23,404	122,208	27,223	122,208	31,164	121,101	36,330	104,057	36,330	84,762	36,330	79,497	36,330
	9	122,208	22,914	122,208	26,461	122,208	30,072	122,208	35,013	110,103	36,330	91,497	36,330	86,073	36,330
	11	122,208	22,444	122,208	25,741	122,208	29,054	122,208	33,506	116,147	36,330	98,304	36,330	92,036	36,330
	13	122,208	21,955	122,208	25,070	122,208	28,176	122,208	32,304	121,158	36,330	104,060	36,330	97,301	36,330
	15	122,208	21,475	122,208	24,415	122,208	27,322	122,208	31,141	122,208	35,130	109,497	36,330	102,624	36,330
	20	122,208	20,596	122,208	23,089	122,208	25,490	122,208	28,536	122,208	31,656	122,208	35,201	115,692	36,330

Air-Cooled Scroll Chiller (R410A)

4. Performance Data

■ ACAH040HETB ($\Delta T = 5^{\circ}\text{C}$)

Flow Rate		Outdoor Temperature ($^{\circ}\text{C}$)													
		-15		-10		-5		0		5		10		15	
372 LPM		Capacity (W)	Power Input (W)	Capacity (W)	Power Input (W)	Capacity (W)	Power Input (W)	Capacity (W)	Power Input (W)	Capacity (W)	Power Input (W)	Capacity (W)	Power Input (W)	Capacity (W)	Power Input (W)
Outlet Water Temp. ($^{\circ}\text{C}$)	-10	88,000	21,123	88,000	21,157	88,000	21,293	88,000	21,419	88,000	21,692	88,000	23,372	84,733	25,525
	-5	104,328	22,538	104,328	22,574	104,328	22,719	104,328	22,854	104,328	23,146	104,328	24,938	104,328	28,392
	0	122,220	23,763	122,220	23,801	122,220	23,954	122,220	24,096	122,220	24,403	122,220	26,294	122,220	29,936
	5	130,000	20,042	130,000	20,076	130,000	20,206	130,000	20,326	130,000	20,587	130,000	22,191	130,000	25,285
	7	130,000	18,676	130,000	18,710	130,000	18,831	130,000	18,945	130,000	19,191	130,000	20,707	130,000	23,636
	9	130,000	18,558	130,000	18,587	130,000	18,707	130,000	18,817	130,000	19,052	130,000	20,502	130,000	23,288
	11	130,000	18,436	130,000	18,466	130,000	18,585	130,000	18,690	130,000	18,916	130,000	20,302	130,000	22,951
	13	130,000	18,199	130,000	18,228	130,000	18,346	130,000	18,447	130,000	18,664	130,000	19,999	130,000	22,538
	15	130,000	17,967	130,000	17,996	130,000	18,112	130,000	18,211	130,000	18,419	130,000	19,701	130,000	22,133
	20	130,000	17,763	130,000	17,792	130,000	17,906	130,000	17,996	130,000	18,184	130,000	19,338	130,000	21,501

Flow Rate		Outdoor Temperature ($^{\circ}\text{C}$)													
		20		25		30		35		40		45		48	
372 LPM		Capacity (W)	Power Input (W)	Capacity (W)	Power Input (W)	Capacity (W)	Power Input (W)	Capacity (W)	Power Input (W)	Capacity (W)	Power Input (W)	Capacity (W)	Power Input (W)	Capacity (W)	Power Input (W)
Outlet Water Temp. ($^{\circ}\text{C}$)	-10	79,107	27,684	77,440	31,437	77,440	35,848	75,779	41,040	72,494	45,413	62,325	45,413	48,328	37,563
	-5	103,378	32,560	101,200	36,975	101,200	42,163	93,171	45,413	80,549	45,413	69,250	45,413	63,156	44,179
	0	122,220	34,685	122,220	40,189	121,113	45,413	103,524	45,413	89,499	45,413	76,945	45,413	72,133	45,413
	5	130,000	29,328	130,000	34,023	130,000	38,844	129,684	45,413	111,864	45,413	95,947	45,413	86,907	43,875
	7	130,000	27,479	130,000	31,963	130,000	36,590	130,000	43,046	117,845	45,413	100,122	45,413	91,803	44,398
	9	130,000	26,904	130,000	31,068	130,000	35,308	130,000	41,110	124,693	45,413	108,077	45,413	95,307	42,571
	11	130,000	26,352	130,000	30,223	130,000	34,113	130,000	39,340	130,000	44,882	114,717	45,413	98,810	41,276
	13	130,000	25,778	130,000	29,436	130,000	33,083	130,000	37,928	130,000	43,026	120,543	45,413	101,857	40,246
	15	130,000	25,214	130,000	28,666	130,000	32,079	130,000	36,563	130,000	41,247	123,500	44,276	103,976	38,953
	20	130,000	24,182	130,000	27,109	130,000	29,928	130,000	33,505	130,000	37,168	123,500	38,438	109,061	36,243

Air-Cooled Scroll Chiller (R410A)

4. Performance Data

■ ACAH040HETB ($\Delta T = 7^{\circ}\text{C}$)

Flow Rate		Outdoor Temperature ($^{\circ}\text{C}$)													
		-15		-10		-5		0		5		10		15	
274 LPM		Capacity (W)	Power Input (W)	Capacity (W)	Power Input (W)	Capacity (W)	Power Input (W)	Capacity (W)	Power Input (W)	Capacity (W)	Power Input (W)	Capacity (W)	Power Input (W)	Capacity (W)	Power Input (W)
Outlet Water Temp. ($^{\circ}\text{C}$)	-10	90,552	21,228	90,552	21,262	90,552	21,399	90,552	21,526	90,552	21,801	90,552	23,489	87,191	25,653
	-5	107,354	22,650	107,354	22,687	107,354	22,833	107,354	22,969	107,354	23,261	107,354	25,063	107,354	28,534
	0	125,764	23,881	125,764	23,920	125,764	24,074	125,764	24,217	125,764	24,525	125,764	26,425	125,764	30,085
	5	133,770	20,143	133,770	20,176	133,770	20,307	133,770	20,428	133,770	20,690	133,770	22,302	133,770	25,412
	7	133,770	18,769	133,770	18,804	133,770	18,925	133,770	19,040	133,770	19,287	133,770	20,810	133,770	23,755
	9	133,770	18,650	133,770	18,680	133,770	18,801	133,770	18,911	133,770	19,148	133,770	20,605	133,770	23,405
	11	133,770	18,529	133,770	18,558	133,770	18,678	133,770	18,784	133,770	19,010	133,770	20,404	133,770	23,066
	13	133,770	18,290	133,770	18,319	133,770	18,437	133,770	18,540	133,770	18,758	133,770	20,099	133,770	22,651
	15	133,770	18,057	133,770	18,086	133,770	18,203	133,770	18,302	133,770	18,511	133,770	19,800	133,770	22,244
	20	133,770	17,852	133,770	17,880	133,770	17,996	133,770	18,086	133,770	18,274	133,770	19,435	133,770	21,609

Flow Rate		Outdoor Temperature ($^{\circ}\text{C}$)													
		20		25		30		35		40		45		48	
274 LPM		Capacity (W)	Power Input (W)	Capacity (W)	Power Input (W)	Capacity (W)	Power Input (W)	Capacity (W)	Power Input (W)	Capacity (W)	Power Input (W)	Capacity (W)	Power Input (W)	Capacity (W)	Power Input (W)
Outlet Water Temp. ($^{\circ}\text{C}$)	-10	81,401	27,823	79,686	31,595	79,686	36,028	77,976	41,245	74,226	45,413	63,814	45,413	49,729	37,751
	-5	106,376	32,723	104,135	37,160	104,135	42,373	95,396	45,413	82,473	45,413	70,904	45,413	64,987	44,400
	0	125,764	34,858	125,764	40,390	124,005	45,413	105,996	45,413	91,636	45,413	78,782	45,413	73,855	45,413
	5	133,770	29,474	133,770	34,193	133,770	39,038	132,780	45,413	114,535	45,413	98,238	45,413	89,427	44,094
	7	133,770	27,616	133,770	32,123	133,770	36,773	133,770	43,262	120,659	45,413	102,513	45,413	94,466	44,620
	9	133,770	27,038	133,770	31,224	133,770	35,485	133,770	41,315	127,670	45,413	110,658	45,413	98,071	42,784
	11	133,770	26,484	133,770	30,374	133,770	34,284	133,770	39,537	133,770	45,107	117,457	45,413	101,676	41,483
	13	133,770	25,907	133,770	29,583	133,770	33,248	133,770	38,118	133,770	43,241	123,422	45,413	104,810	40,448
	15	133,770	25,340	133,770	28,809	133,770	32,239	133,770	36,746	133,770	41,453	127,082	44,497	106,992	39,148
	20	133,770	24,303	133,770	27,245	133,770	30,078	133,770	33,673	133,770	37,353	127,082	38,630	112,223	36,424

Air-Cooled Scroll Chiller (R410A)

4. Performance Data

■ ACAH040HETB ($\Delta T = 10^{\circ}\text{C}$)

Flow Rate		Outdoor Temperature ($^{\circ}\text{C}$)													
		-15		-10		-5		0		5		10		15	
200 LPM		Capacity (W)	Power Input (W)	Capacity (W)	Power Input (W)	Capacity (W)	Power Input (W)	Capacity (W)	Power Input (W)	Capacity (W)	Power Input (W)	Capacity (W)	Power Input (W)	Capacity (W)	Power Input (W)
Outlet Water Temp. ($^{\circ}\text{C}$)	-10	94,336	21,397	94,336	21,432	94,336	21,570	94,336	21,698	94,336	21,974	94,336	23,676	90,834	25,857
	-5	111,840	22,831	111,840	22,867	111,840	23,015	111,840	23,151	111,840	23,446	111,840	25,262	111,840	28,762
	0	131,020	24,072	131,020	24,110	131,020	24,266	131,020	24,410	131,020	24,721	131,020	26,635	131,020	30,325
	5	139,360	20,303	139,360	20,337	139,360	20,468	139,360	20,590	139,360	20,854	139,360	22,479	139,360	25,614
	7	139,360	18,919	139,360	18,953	139,360	19,076	139,360	19,191	139,360	19,440	139,360	20,976	139,360	23,944
	9	139,360	18,799	139,360	18,829	139,360	18,951	139,360	19,061	139,360	19,300	139,360	20,769	139,360	23,591
	11	139,360	18,676	139,360	18,706	139,360	18,827	139,360	18,933	139,360	19,162	139,360	20,566	139,360	23,249
	13	139,360	18,436	139,360	18,465	139,360	18,584	139,360	18,687	139,360	18,907	139,360	20,259	139,360	22,831
	15	139,360	18,201	139,360	18,230	139,360	18,348	139,360	18,447	139,360	18,658	139,360	19,957	139,360	22,421
	20	139,360	17,994	139,360	18,023	139,360	18,139	139,360	18,230	139,360	18,420	139,360	19,589	139,360	21,781

Flow Rate		Outdoor Temperature ($^{\circ}\text{C}$)													
		20		25		30		35		40		45		48	
200 LPM		Capacity (W)	Power Input (W)	Capacity (W)	Power Input (W)	Capacity (W)	Power Input (W)	Capacity (W)	Power Input (W)	Capacity (W)	Power Input (W)	Capacity (W)	Power Input (W)	Capacity (W)	Power Input (W)
Outlet Water Temp. ($^{\circ}\text{C}$)	-10	84,803	28,044	83,016	31,846	83,016	36,314	81,235	41,573	76,717	45,413	65,955	45,413	51,807	38,051
	-5	110,822	32,984	108,486	37,455	108,486	42,711	98,598	45,413	85,241	45,413	73,283	45,413	67,703	44,754
	0	131,020	35,136	131,020	40,712	128,167	45,413	109,553	45,413	94,712	45,413	81,426	45,413	76,334	45,413
	5	139,360	29,709	139,360	34,465	139,360	39,349	137,237	45,413	118,379	45,413	101,535	45,413	93,164	44,445
	7	139,360	27,836	139,360	32,378	139,360	37,066	139,360	43,606	124,709	45,413	105,953	45,413	98,413	44,975
	9	139,360	27,253	139,360	31,472	139,360	35,767	139,360	41,644	131,955	45,413	114,371	45,413	102,169	43,124
	11	139,360	26,695	139,360	30,616	139,360	34,556	139,360	39,852	139,199	45,413	121,399	45,413	105,924	41,813
	13	139,360	26,113	139,360	29,818	139,360	33,513	139,360	38,421	139,360	43,585	127,564	45,413	109,190	40,770
	15	139,360	25,542	139,360	29,039	139,360	32,496	139,360	37,039	139,360	41,783	132,392	44,851	111,463	39,459
	20	139,360	24,496	139,360	27,462	139,360	30,318	139,360	33,941	139,360	37,651	132,392	38,937	116,913	36,714

Air-Cooled Scroll Chiller (R410A)

4. Performance Data

■ ACAH045HETB ($\Delta T = 5^{\circ}\text{C}$)

Flow Rate		Outdoor Temperature ($^{\circ}\text{C}$)													
		-15		-10		-5		0		5		10		15	
422 LPM		Capacity (W)	Power Input (W)	Capacity (W)	Power Input (W)	Capacity (W)	Power Input (W)	Capacity (W)	Power Input (W)	Capacity (W)	Power Input (W)	Capacity (W)	Power Input (W)	Capacity (W)	Power Input (W)
Outlet Water Temp. ($^{\circ}\text{C}$)	-10	95,096	26,549	95,096	26,592	95,096	26,763	95,096	26,922	95,096	27,265	95,096	29,377	91,566	32,083
	-5	112,740	28,328	112,740	28,373	112,740	28,556	112,740	28,726	112,740	29,092	112,740	31,345	112,740	35,687
	0	132,075	29,867	132,075	29,915	132,075	30,108	132,075	30,287	132,075	30,673	132,075	33,048	132,075	37,626
	5	148,000	26,540	148,000	26,584	148,000	26,756	148,000	26,915	148,000	27,260	148,000	29,385	148,000	33,482
	7	148,000	24,730	148,000	24,775	148,000	24,936	148,000	25,086	148,000	25,412	148,000	27,419	148,000	31,298
	9	148,000	24,573	148,000	24,613	148,000	24,772	148,000	24,916	148,000	25,228	148,000	27,148	148,000	30,838
	11	148,000	24,413	148,000	24,452	148,000	24,610	148,000	24,749	148,000	25,048	148,000	26,883	148,000	30,391
	13	148,000	24,098	148,000	24,137	148,000	24,293	148,000	24,427	148,000	24,715	148,000	26,481	148,000	29,844
	15	148,000	23,792	148,000	23,830	148,000	23,984	148,000	24,114	148,000	24,390	148,000	26,088	148,000	29,308
	20	148,000	23,521	148,000	23,559	148,000	23,711	148,000	23,830	148,000	24,078	148,000	25,607	148,000	28,472

Flow Rate		Outdoor Temperature ($^{\circ}\text{C}$)													
		20		25		30		35		40		45		48	
422 LPM		Capacity (W)	Power Input (W)	Capacity (W)	Power Input (W)	Capacity (W)	Power Input (W)	Capacity (W)	Power Input (W)	Capacity (W)	Power Input (W)	Capacity (W)	Power Input (W)	Capacity (W)	Power Input (W)
Outlet Water Temp. ($^{\circ}\text{C}$)	-10	90,060	36,658	88,162	41,628	88,162	47,469	86,271	54,343	75,779	47,609	63,148	46,012	48,569	37,751
	-5	112,740	41,301	112,740	47,910	112,740	54,633	101,466	57,523	99,030	55,995	82,522	54,117	63,471	44,400
	0	132,075	43,596	132,075	50,514	131,895	57,523	112,740	57,523	113,036	57,523	96,675	57,058	74,357	46,813
	5	148,000	38,835	148,000	45,052	148,000	51,436	141,229	57,523	133,900	54,517	111,240	52,652	87,342	44,094
	7	148,000	36,387	148,000	42,324	148,000	48,451	148,000	56,900	134,570	52,009	117,162	53,142	92,262	44,620
	9	148,000	35,625	148,000	41,139	148,000	46,754	148,000	54,436	135,239	49,397	119,686	50,291	95,783	42,784
	11	148,000	34,895	148,000	40,020	148,000	45,171	148,000	52,093	136,578	47,291	122,211	48,379	99,304	41,483
	13	148,000	34,134	148,000	38,978	148,000	43,807	148,000	50,223	140,595	46,668	124,406	46,868	102,366	40,448
	15	148,000	33,388	148,000	37,958	148,000	42,478	148,000	48,416	148,000	53,217	124,735	44,718	104,496	39,148
	20	148,000	32,021	148,000	35,897	148,000	39,630	148,000	44,366	148,000	47,954	124,735	38,822	109,606	36,424

Air-Cooled Scroll Chiller (R410A)

4. Performance Data

■ ACAH045HETB ($\Delta T = 7^{\circ}\text{C}$)

Flow Rate		Outdoor Temperature ($^{\circ}\text{C}$)													
		-15		-10		-5		0		5		10		15	
312 LPM		Capacity (W)	Power Input (W)	Capacity (W)	Power Input (W)	Capacity (W)	Power Input (W)	Capacity (W)	Power Input (W)	Capacity (W)	Power Input (W)	Capacity (W)	Power Input (W)	Capacity (W)	Power Input (W)
Outlet Water Temp. ($^{\circ}\text{C}$)	-10	97,854	26,682	97,854	26,725	97,854	26,897	97,854	27,057	97,854	27,402	97,854	29,524	94,221	32,243
	-5	116,010	28,469	116,010	28,515	116,010	28,699	116,010	28,869	116,010	29,237	116,010	31,502	116,010	35,865
	0	135,905	30,017	135,905	30,065	135,905	30,259	135,905	30,438	135,905	30,826	135,905	33,214	135,905	37,814
	5	152,292	26,672	152,292	26,717	152,292	26,889	152,292	27,050	152,292	27,397	152,292	29,531	152,292	33,649
	7	152,292	24,854	152,292	24,899	152,292	25,060	152,292	25,211	152,292	25,539	152,292	27,556	152,292	31,455
	9	152,292	24,696	152,292	24,736	152,292	24,895	152,292	25,041	152,292	25,355	152,292	27,284	152,292	30,992
	11	152,292	24,535	152,292	24,574	152,292	24,733	152,292	24,873	152,292	25,173	152,292	27,018	152,292	30,543
	13	152,292	24,219	152,292	24,258	152,292	24,414	152,292	24,550	152,292	24,838	152,292	26,614	152,292	29,994
	15	152,292	23,911	152,292	23,949	152,292	24,104	152,292	24,234	152,292	24,512	152,292	26,218	152,292	29,455
	20	152,292	23,639	152,292	23,677	152,292	23,829	152,292	23,949	152,292	24,198	152,292	25,735	152,292	28,614

Flow Rate		Outdoor Temperature ($^{\circ}\text{C}$)													
		20		25		30		35		40		45		48	
312 LPM		Capacity (W)	Power Input (W)	Capacity (W)	Power Input (W)	Capacity (W)	Power Input (W)	Capacity (W)	Power Input (W)	Capacity (W)	Power Input (W)	Capacity (W)	Power Input (W)	Capacity (W)	Power Input (W)
Outlet Water Temp. ($^{\circ}\text{C}$)	-10	92,672	36,842	90,719	41,836	90,719	47,707	88,773	54,615	77,977	47,847	64,979	46,242	49,978	37,940
	-5	116,010	41,508	116,010	48,150	116,010	54,906	103,889	57,523	101,902	56,275	84,915	54,387	65,312	44,622
	0	135,905	43,814	135,905	50,767	135,045	57,523	115,432	57,523	115,736	57,523	99,478	57,343	76,513	47,047
	5	152,292	39,029	152,292	45,277	152,292	51,693	144,602	57,523	137,783	54,790	114,466	52,915	89,874	44,315
	7	152,292	36,569	152,292	42,536	152,292	48,693	152,292	57,185	138,472	52,269	120,559	53,408	94,938	44,843
	9	152,292	35,803	152,292	41,345	152,292	46,987	152,292	54,708	139,161	49,644	123,157	50,543	98,561	42,998
	11	152,292	35,069	152,292	40,220	152,292	45,397	152,292	52,353	140,539	47,527	125,755	48,621	102,184	41,690
	13	152,292	34,305	152,292	39,173	152,292	44,026	152,292	50,474	144,672	46,901	128,013	47,103	105,334	40,650
	15	152,292	33,555	152,292	38,148	152,292	42,690	152,292	48,658	152,292	53,483	128,352	44,942	107,527	39,344
	20	152,292	32,181	152,292	36,077	152,292	39,828	152,292	44,588	152,292	48,194	128,352	39,016	112,785	36,606

Air-Cooled Scroll Chiller (R410A)

4. Performance Data

■ ACAH045HETB ($\Delta T = 10^{\circ}\text{C}$)

Flow Rate		Outdoor Temperature ($^{\circ}\text{C}$)													
		-15		-10		-5		0		5		10		15	
227 LPM		Capacity (W)	Power Input (W)	Capacity (W)	Power Input (W)	Capacity (W)	Power Input (W)	Capacity (W)	Power Input (W)	Capacity (W)	Power Input (W)	Capacity (W)	Power Input (W)	Capacity (W)	Power Input (W)
Outlet Water Temp. ($^{\circ}\text{C}$)	-10	101,943	26,894	101,943	26,938	101,943	27,111	101,943	27,272	101,943	27,620	101,943	29,759	98,159	32,500
	-5	120,858	28,696	120,858	28,742	120,858	28,927	120,858	29,099	120,858	29,470	120,858	31,752	120,858	36,151
	0	141,585	30,256	141,585	30,304	141,585	30,500	141,585	30,681	141,585	31,072	141,585	33,478	141,585	38,115
	5	158,656	26,885	158,656	26,929	158,656	27,103	158,656	27,265	158,656	27,615	158,656	29,767	158,656	33,917
	7	158,656	25,052	158,656	25,097	158,656	25,260	158,656	25,412	158,656	25,742	158,656	27,775	158,656	31,705
	9	158,656	24,893	158,656	24,933	158,656	25,094	158,656	25,240	158,656	25,556	158,656	27,501	158,656	31,239
	11	158,656	24,730	158,656	24,770	158,656	24,930	158,656	25,071	158,656	25,373	158,656	27,233	158,656	30,786
	13	158,656	24,412	158,656	24,451	158,656	24,609	158,656	24,745	158,656	25,036	158,656	26,826	158,656	30,232
	15	158,656	24,101	158,656	24,140	158,656	24,295	158,656	24,427	158,656	24,707	158,656	26,427	158,656	29,689
	20	158,656	23,827	158,656	23,865	158,656	24,019	158,656	24,139	158,656	24,391	158,656	25,940	158,656	28,842

Flow Rate		Outdoor Temperature ($^{\circ}\text{C}$)													
		20		25		30		35		40		45		48	
227 LPM		Capacity (W)	Power Input (W)	Capacity (W)	Power Input (W)	Capacity (W)	Power Input (W)	Capacity (W)	Power Input (W)	Capacity (W)	Power Input (W)	Capacity (W)	Power Input (W)	Capacity (W)	Power Input (W)
Outlet Water Temp. ($^{\circ}\text{C}$)	-10	96,545	37,135	94,510	42,170	94,510	48,086	92,482	55,050	81,236	48,228	67,694	46,610	52,066	38,242
	-5	120,858	41,838	120,858	48,533	120,858	55,343	107,376	57,523	106,160	56,723	88,464	54,820	68,041	44,977
	0	141,585	44,162	141,585	51,171	139,577	57,523	119,306	57,523	119,620	57,523	103,140	57,523	79,710	47,422
	5	158,656	39,340	158,656	45,638	158,656	52,105	149,454	57,523	143,541	55,226	119,249	53,336	93,630	44,667
	7	158,656	36,860	158,656	42,874	158,656	49,081	158,334	57,523	144,259	52,685	125,597	53,833	98,905	45,200
	9	158,656	36,088	158,656	41,674	158,656	47,361	158,656	55,144	144,976	50,040	128,304	50,945	102,680	43,340
	11	158,656	35,349	158,656	40,540	158,656	45,758	158,656	52,770	146,412	47,905	131,010	49,008	106,454	42,022
	13	158,656	34,578	158,656	39,485	158,656	44,376	158,656	50,876	150,718	47,275	133,363	47,478	109,736	40,973
	15	158,656	33,822	158,656	38,452	158,656	43,030	158,656	49,045	158,656	53,909	133,716	45,300	112,020	39,657
	20	158,656	32,437	158,656	36,364	158,656	40,145	158,656	44,943	158,656	48,577	133,716	39,327	117,498	36,897

Air-Cooled Scroll Chiller (R410A)

4. Performance Data

■ ACAH050HETB ($\Delta T = 5^{\circ}\text{C}$)

Flow Rate		Outdoor Temperature ($^{\circ}\text{C}$)													
		-15		-10		-5		0		5		10		15	
491 LPM		Capacity (W)	Power Input (W)	Capacity (W)	Power Input (W)	Capacity (W)	Power Input (W)	Capacity (W)	Power Input (W)	Capacity (W)	Power Input (W)	Capacity (W)	Power Input (W)	Capacity (W)	Power Input (W)
Outlet Water Temp. ($^{\circ}\text{C}$)	-10	129,360	31,684	129,360	31,735	129,360	31,940	129,360	32,129	129,360	32,539	129,360	35,059	124,558	38,288
	-5	154,845	33,587	154,845	33,641	154,845	33,858	154,845	34,059	154,845	34,493	154,845	37,165	154,845	42,312
	0	171,000	32,270	171,000	32,321	171,000	32,530	171,000	32,723	171,000	33,140	171,000	35,706	171,000	40,652
	5	171,000	25,277	171,000	25,319	171,000	25,482	171,000	25,634	171,000	25,963	171,000	27,986	171,000	31,889
	7	171,000	23,553	171,000	23,596	171,000	23,749	171,000	23,892	171,000	24,203	171,000	26,114	171,000	29,809
	9	171,000	23,404	171,000	23,442	171,000	23,593	171,000	23,731	171,000	24,028	171,000	25,857	171,000	29,370
	11	171,000	23,251	171,000	23,288	171,000	23,439	171,000	23,571	171,000	23,856	171,000	25,604	171,000	28,945
	13	171,000	22,952	171,000	22,989	171,000	23,137	171,000	23,265	171,000	23,539	171,000	25,221	171,000	28,424
	15	171,000	22,660	171,000	22,696	171,000	22,842	171,000	22,966	171,000	23,229	171,000	24,846	171,000	27,914
	20	171,000	22,402	171,000	22,438	171,000	22,583	171,000	22,696	171,000	22,932	171,000	24,388	171,000	27,117

Flow Rate		Outdoor Temperature ($^{\circ}\text{C}$)													
		20		25		30		35		40		45		48	
491 LPM		Capacity (W)	Power Input (W)	Capacity (W)	Power Input (W)	Capacity (W)	Power Input (W)	Capacity (W)	Power Input (W)	Capacity (W)	Power Input (W)	Capacity (W)	Power Input (W)	Capacity (W)	Power Input (W)
Outlet Water Temp. ($^{\circ}\text{C}$)	-10	116,287	41,526	113,837	47,156	113,837	53,773	98,612	54,496	85,253	54,496	74,790	54,496	70,113	54,496
	-5	153,490	48,807	146,172	54,496	128,186	54,496	109,569	54,496	94,726	54,496	83,100	54,496	77,903	54,496
	0	171,000	47,102	170,746	54,496	149,736	54,496	126,410	54,496	108,028	54,496	92,334	54,496	86,559	54,496
	5	171,000	36,987	171,000	42,908	171,000	48,988	162,312	54,496	140,009	54,496	115,136	54,496	107,945	54,496
	7	171,000	34,655	171,000	40,310	171,000	46,146	171,000	54,288	147,495	54,496	120,146	54,496	112,682	54,496
	9	171,000	33,930	171,000	39,182	171,000	44,529	171,000	51,846	156,065	54,496	129,692	54,496	122,003	54,496
	11	171,000	33,234	171,000	38,116	171,000	43,022	171,000	49,614	164,633	54,496	139,340	54,496	130,455	54,496
	13	171,000	32,510	171,000	37,123	171,000	41,722	171,000	47,833	171,000	54,262	147,499	54,496	137,919	54,496
	15	171,000	31,799	171,000	36,152	171,000	40,456	171,000	46,112	171,000	52,018	155,206	54,496	145,464	54,496
	20	171,000	30,497	171,000	34,189	171,000	37,744	171,000	42,255	171,000	46,874	171,000	52,125	161,955	53,820

Air-Cooled Scroll Chiller (R410A)

4. Performance Data

■ ACAH050HETB ($\Delta T = 7^{\circ}\text{C}$)

Flow Rate		Outdoor Temperature ($^{\circ}\text{C}$)													
		-15		-10		-5		0		5		10		15	
360 LPM		Capacity (W)	Power Input (W)	Capacity (W)	Power Input (W)	Capacity (W)	Power Input (W)	Capacity (W)	Power Input (W)	Capacity (W)	Power Input (W)	Capacity (W)	Power Input (W)	Capacity (W)	Power Input (W)
Outlet Water Temp. ($^{\circ}\text{C}$)	-10	133,111	31,842	133,111	31,894	133,111	32,099	133,111	32,290	133,111	32,701	133,111	35,234	128,170	38,479
	-5	159,336	33,755	159,336	33,809	159,336	34,027	159,336	34,229	159,336	34,666	159,336	37,350	159,336	42,524
	0	175,959	32,431	175,959	32,483	175,959	32,692	175,959	32,886	175,959	33,305	175,959	35,885	175,959	40,856
	5	175,959	25,403	175,959	25,446	175,959	25,610	175,959	25,763	175,959	26,093	175,959	28,126	175,959	32,048
	7	175,959	23,671	175,959	23,714	175,959	23,868	175,959	24,012	175,959	24,324	175,959	26,245	175,959	29,958
	9	175,959	23,521	175,959	23,559	175,959	23,711	175,959	23,849	175,959	24,148	175,959	25,986	175,959	29,517
	11	175,959	23,367	175,959	23,405	175,959	23,556	175,959	23,689	175,959	23,975	175,959	25,732	175,959	29,090
	13	175,959	23,066	175,959	23,103	175,959	23,252	175,959	23,381	175,959	23,656	175,959	25,347	175,959	28,566
	15	175,959	22,773	175,959	22,810	175,959	22,957	175,959	23,081	175,959	23,345	175,959	24,971	175,959	28,053
	20	175,959	22,514	175,959	22,550	175,959	22,695	175,959	22,809	175,959	23,047	175,959	24,510	175,959	27,252

Flow Rate		Outdoor Temperature ($^{\circ}\text{C}$)													
		20		25		30		35		40		45		48	
360 LPM		Capacity (W)	Power Input (W)	Capacity (W)	Power Input (W)	Capacity (W)	Power Input (W)	Capacity (W)	Power Input (W)	Capacity (W)	Power Input (W)	Capacity (W)	Power Input (W)	Capacity (W)	Power Input (W)
Outlet Water Temp. ($^{\circ}\text{C}$)	-10	119,660	41,734	117,138	47,392	117,138	54,042	100,967	54,496	87,289	54,496	76,576	54,496	71,787	54,496
	-5	157,941	49,051	149,663	54,496	131,247	54,496	112,186	54,496	96,988	54,496	85,085	54,496	79,763	54,496
	0	175,959	47,338	174,824	54,496	153,312	54,496	129,429	54,496	110,608	54,496	94,539	54,496	88,626	54,496
	5	175,959	37,172	175,959	43,123	175,959	49,233	166,188	54,496	143,352	54,496	117,886	54,496	110,523	54,496
	7	175,959	34,829	175,959	40,512	175,959	46,376	175,753	54,496	151,017	54,496	123,015	54,496	115,373	54,496
	9	175,959	34,099	175,959	39,378	175,959	44,752	175,959	52,105	159,792	54,496	132,789	54,496	124,917	54,496
	11	175,959	33,401	175,959	38,306	175,959	43,237	175,959	49,862	168,564	54,496	142,668	54,496	133,571	54,496
	13	175,959	32,672	175,959	37,309	175,959	41,931	175,959	48,073	175,836	54,496	151,021	54,496	141,213	54,496
	15	175,959	31,958	175,959	36,333	175,959	40,659	175,959	46,343	175,959	52,279	158,912	54,496	148,938	54,496
	20	175,959	30,650	175,959	34,360	175,959	37,933	175,959	42,466	175,959	47,108	175,959	52,385	166,652	54,089

Air-Cooled Scroll Chiller (R410A)

4. Performance Data

■ ACAH050HETB ($\Delta T = 10^{\circ}\text{C}$)

Flow Rate		Outdoor Temperature ($^{\circ}\text{C}$)													
		-15		-10		-5		0		5		10		15	
263 LPM		Capacity (W)	Power Input (W)	Capacity (W)	Power Input (W)	Capacity (W)	Power Input (W)	Capacity (W)	Power Input (W)	Capacity (W)	Power Input (W)	Capacity (W)	Power Input (W)	Capacity (W)	Power Input (W)
Outlet Water Temp. ($^{\circ}\text{C}$)	-10	138,674	32,096	138,674	32,147	138,674	32,355	138,674	32,547	138,674	32,962	138,674	35,514	133,526	38,786
	-5	165,994	34,024	165,994	34,078	165,994	34,298	165,994	34,502	165,994	34,941	165,994	37,648	165,994	42,862
	0	183,312	32,689	183,312	32,741	183,312	32,953	183,312	33,148	183,312	33,571	183,312	36,171	183,312	41,181
	5	183,312	25,605	183,312	25,648	183,312	25,814	183,312	25,968	183,312	26,301	183,312	28,350	183,312	32,303
	7	183,312	23,860	183,312	23,903	183,312	24,058	183,312	24,203	183,312	24,517	183,312	26,454	183,312	30,197
	9	183,312	23,708	183,312	23,746	183,312	23,900	183,312	24,039	183,312	24,340	183,312	26,193	183,312	29,752
	11	183,312	23,553	183,312	23,591	183,312	23,743	183,312	23,878	183,312	24,166	183,312	25,937	183,312	29,321
	13	183,312	23,250	183,312	23,287	183,312	23,438	183,312	23,568	183,312	23,845	183,312	25,549	183,312	28,794
	15	183,312	22,954	183,312	22,991	183,312	23,139	183,312	23,265	183,312	23,531	183,312	25,169	183,312	28,276
	20	183,312	22,693	183,312	22,730	183,312	22,876	183,312	22,991	183,312	23,230	183,312	24,705	183,312	27,469

Flow Rate		Outdoor Temperature ($^{\circ}\text{C}$)													
		20		25		30		35		40		45		48	
263 LPM		Capacity (W)	Power Input (W)	Capacity (W)	Power Input (W)	Capacity (W)	Power Input (W)	Capacity (W)	Power Input (W)	Capacity (W)	Power Input (W)	Capacity (W)	Power Input (W)	Capacity (W)	Power Input (W)
Outlet Water Temp. ($^{\circ}\text{C}$)	-10	124,660	42,066	122,033	47,769	122,033	54,472	104,356	54,496	90,219	54,496	79,146	54,496	74,196	54,496
	-5	164,541	49,442	154,685	54,496	135,652	54,496	115,951	54,496	100,243	54,496	87,940	54,496	82,440	54,496
	0	183,312	47,714	180,691	54,496	158,457	54,496	133,772	54,496	114,320	54,496	97,711	54,496	91,600	54,496
	5	183,312	37,468	183,312	43,466	183,312	49,625	171,765	54,496	148,163	54,496	121,842	54,496	114,232	54,496
	7	183,312	35,106	183,312	40,834	183,312	46,745	181,651	54,496	156,086	54,496	127,144	54,496	119,245	54,496
	9	183,312	34,371	183,312	39,691	183,312	45,108	183,312	52,520	165,155	54,496	137,246	54,496	129,109	54,496
	11	183,312	33,666	183,312	38,611	183,312	43,581	183,312	50,259	174,221	54,496	147,456	54,496	138,053	54,496
	13	183,312	32,932	183,312	37,606	183,312	42,265	183,312	48,455	181,737	54,496	156,090	54,496	145,952	54,496
	15	183,312	32,212	183,312	36,622	183,312	40,982	183,312	46,712	183,312	52,695	164,245	54,496	153,936	54,496
	20	183,312	30,894	183,312	34,634	183,312	38,235	183,312	42,805	183,312	47,483	183,312	52,802	173,538	54,496

Air-Cooled Scroll Chiller (R410A)

4. Performance Data

■ ACAH060HETB ($\Delta T = 5^{\circ}\text{C}$)

Flow Rate		Outdoor Temperature ($^{\circ}\text{C}$)													
		-15		-10		-5		0		5		10		15	
558 LPM		Capacity (W)	Power Input (W)	Capacity (W)	Power Input (W)	Capacity (W)	Power Input (W)	Capacity (W)	Power Input (W)	Capacity (W)	Power Input (W)	Capacity (W)	Power Input (W)	Capacity (W)	Power Input (W)
Outlet Water Temp. ($^{\circ}\text{C}$)	-10	132,000	31,684	132,000	31,735	132,000	31,940	132,000	32,129	132,000	32,539	132,000	35,059	127,100	38,288
	-5	156,492	33,807	156,492	33,861	156,492	34,079	156,492	34,281	156,492	34,718	156,492	37,407	156,492	42,589
	0	183,330	35,644	183,330	35,701	183,330	35,931	183,330	36,145	183,330	36,605	183,330	39,440	183,330	44,903
	5	195,000	30,064	195,000	30,114	195,000	30,308	195,000	30,489	195,000	30,880	195,000	33,286	195,000	37,928
	7	195,000	28,014	195,000	28,065	195,000	28,247	195,000	28,417	195,000	28,786	195,000	31,060	195,000	35,455
	9	195,000	27,837	195,000	27,881	195,000	28,061	195,000	28,225	195,000	28,579	195,000	30,753	195,000	34,933
	11	195,000	27,655	195,000	27,699	195,000	27,878	195,000	28,035	195,000	28,374	195,000	30,453	195,000	34,427
	13	195,000	27,298	195,000	27,342	195,000	27,519	195,000	27,671	195,000	27,997	195,000	29,998	195,000	33,807
	15	195,000	26,951	195,000	26,994	195,000	27,168	195,000	27,316	195,000	27,629	195,000	29,552	195,000	33,200
	20	195,000	26,645	195,000	26,687	195,000	26,859	195,000	26,994	195,000	27,275	195,000	29,007	195,000	32,252

Flow Rate		Outdoor Temperature ($^{\circ}\text{C}$)													
		20		25		30		35		40		45		48	
558 LPM		Capacity (W)	Power Input (W)	Capacity (W)	Power Input (W)	Capacity (W)	Power Input (W)	Capacity (W)	Power Input (W)	Capacity (W)	Power Input (W)	Capacity (W)	Power Input (W)	Capacity (W)	Power Input (W)
Outlet Water Temp. ($^{\circ}\text{C}$)	-10	118,660	41,526	116,160	47,156	116,160	53,773	113,668	61,559	108,742	68,120	93,488	68,120	72,492	56,345
	-5	155,068	48,841	151,800	55,462	151,800	63,244	139,757	68,120	120,824	68,120	103,875	68,120	94,734	66,269
	0	183,330	52,027	183,330	60,284	181,669	68,120	155,285	68,120	134,249	68,120	115,417	68,120	108,199	68,120
	5	195,000	43,992	195,000	51,034	195,000	58,266	194,525	68,120	167,796	68,120	143,920	68,120	130,361	65,812
	7	195,000	41,219	195,000	47,944	195,000	54,885	195,000	64,570	176,768	68,120	150,182	68,120	137,705	66,597
	9	195,000	40,355	195,000	46,602	195,000	52,962	195,000	61,665	187,039	68,120	162,115	68,120	142,960	63,857
	11	195,000	39,529	195,000	45,334	195,000	51,169	195,000	59,010	195,000	67,323	172,076	68,120	148,215	61,915
	13	195,000	38,667	195,000	44,154	195,000	49,624	195,000	56,892	195,000	64,539	180,815	68,120	152,785	60,369
	15	195,000	37,821	195,000	42,999	195,000	48,118	195,000	54,845	195,000	61,870	185,250	66,413	155,965	58,430
	20	195,000	36,273	195,000	40,664	195,000	44,893	195,000	50,258	195,000	55,751	185,250	57,657	163,591	54,364

Air-Cooled Scroll Chiller (R410A)

4. Performance Data

■ ACAH060HETB ($\Delta T = 7^{\circ}\text{C}$)

Flow Rate		Outdoor Temperature ($^{\circ}\text{C}$)													
		-15		-10		-5		0		5		10		15	
411 LPM		Capacity (W)	Power Input (W)	Capacity (W)	Power Input (W)	Capacity (W)	Power Input (W)	Capacity (W)	Power Input (W)	Capacity (W)	Power Input (W)	Capacity (W)	Power Input (W)	Capacity (W)	Power Input (W)
Outlet Water Temp. ($^{\circ}\text{C}$)	-10	135,828	31,842	135,828	31,894	135,828	32,099	135,828	32,290	135,828	32,701	135,828	35,234	130,786	38,479
	-5	161,030	33,976	161,030	34,030	161,030	34,250	161,030	34,453	161,030	34,892	161,030	37,594	161,030	42,802
	0	188,647	35,822	188,647	35,880	188,647	36,111	188,647	36,325	188,647	36,788	188,647	39,637	188,647	45,128
	5	200,655	30,214	200,655	30,265	200,655	30,460	200,655	30,642	200,655	31,035	200,655	33,453	200,655	38,118
	7	200,655	28,154	200,655	28,205	200,655	28,388	200,655	28,559	200,655	28,930	200,655	31,215	200,655	35,632
	9	200,655	27,976	200,655	28,021	200,655	28,201	200,655	28,366	200,655	28,721	200,655	30,907	200,655	35,107
	11	200,655	27,793	200,655	27,837	200,655	28,017	200,655	28,176	200,655	28,516	200,655	30,606	200,655	34,599
	13	200,655	27,435	200,655	27,479	200,655	27,656	200,655	27,810	200,655	28,137	200,655	30,148	200,655	33,977
	15	200,655	27,086	200,655	27,129	200,655	27,304	200,655	27,452	200,655	27,767	200,655	29,700	200,655	33,366
	20	200,655	26,778	200,655	26,821	200,655	26,994	200,655	27,129	200,655	27,412	200,655	29,152	200,655	32,413

Flow Rate		Outdoor Temperature ($^{\circ}\text{C}$)													
		20		25		30		35		40		45		48	
411 LPM		Capacity (W)	Power Input (W)	Capacity (W)	Power Input (W)	Capacity (W)	Power Input (W)	Capacity (W)	Power Input (W)	Capacity (W)	Power Input (W)	Capacity (W)	Power Input (W)	Capacity (W)	Power Input (W)
Outlet Water Temp. ($^{\circ}\text{C}$)	-10	122,102	41,734	119,529	47,392	119,529	54,042	116,964	61,867	111,338	68,120	95,720	68,120	74,594	56,626
	-5	159,565	49,085	156,202	55,739	156,202	63,560	143,094	68,120	123,709	68,120	106,356	68,120	97,481	66,600
	0	188,647	52,288	188,647	60,585	186,008	68,120	158,994	68,120	137,455	68,120	118,173	68,120	110,783	68,120
	5	200,655	44,212	200,655	51,290	200,655	58,557	199,171	68,120	171,803	68,120	147,357	68,120	134,141	66,141
	7	200,655	41,425	200,655	48,184	200,655	55,159	200,655	64,892	180,989	68,120	153,769	68,120	141,698	66,930
	9	200,655	40,557	200,655	46,835	200,655	53,227	200,655	61,973	191,506	68,120	165,987	68,120	147,106	64,176
	11	200,655	39,726	200,655	45,561	200,655	51,425	200,655	59,305	200,655	67,660	176,185	68,120	152,513	62,224
	13	200,655	38,860	200,655	44,375	200,655	49,872	200,655	57,177	200,655	64,862	185,133	68,120	157,216	60,671
	15	200,655	38,010	200,655	43,214	200,655	48,359	200,655	55,119	200,655	62,179	190,622	66,746	160,488	58,722
	20	200,655	36,454	200,655	40,867	200,655	45,117	200,655	50,509	200,655	56,030	190,622	57,945	168,335	54,636

Air-Cooled Scroll Chiller (R410A)

4. Performance Data

■ ACAH060HETB ($\Delta T = 10^{\circ}\text{C}$)

Flow Rate		Outdoor Temperature ($^{\circ}\text{C}$)													
		-15		-10		-5		0		5		10		15	
300 LPM		Capacity (W)	Power Input (W)	Capacity (W)	Power Input (W)	Capacity (W)	Power Input (W)	Capacity (W)	Power Input (W)	Capacity (W)	Power Input (W)	Capacity (W)	Power Input (W)	Capacity (W)	Power Input (W)
Outlet Water Temp. ($^{\circ}\text{C}$)	-10	141,504	32,096	141,504	32,147	141,504	32,355	141,504	32,547	141,504	32,962	141,504	35,514	136,251	38,786
	-5	167,759	34,246	167,759	34,301	167,759	34,522	167,759	34,727	167,759	35,170	167,759	37,894	167,759	43,142
	0	196,530	36,107	196,530	36,165	196,530	36,398	196,530	36,614	196,530	37,081	196,530	39,953	196,530	45,487
	5	209,040	30,455	209,040	30,505	209,040	30,702	209,040	30,886	209,040	31,282	209,040	33,719	209,040	38,421
	7	209,040	28,378	209,040	28,430	209,040	28,614	209,040	28,787	209,040	29,161	209,040	31,464	209,040	35,915
	9	209,040	28,198	209,040	28,244	209,040	28,426	209,040	28,592	209,040	28,950	209,040	31,153	209,040	35,387
	11	209,040	28,014	209,040	28,059	209,040	28,240	209,040	28,400	209,040	28,743	209,040	30,849	209,040	34,874
	13	209,040	27,653	209,040	27,698	209,040	27,876	209,040	28,031	209,040	28,361	209,040	30,388	209,040	34,247
	15	209,040	27,301	209,040	27,345	209,040	27,522	209,040	27,671	209,040	27,988	209,040	29,936	209,040	33,632
	20	209,040	26,991	209,040	27,034	209,040	27,209	209,040	27,345	209,040	27,630	209,040	29,384	209,040	32,672

Flow Rate		Outdoor Temperature ($^{\circ}\text{C}$)													
		20		25		30		35		40		45		48	
300 LPM		Capacity (W)	Power Input (W)	Capacity (W)	Power Input (W)	Capacity (W)	Power Input (W)	Capacity (W)	Power Input (W)	Capacity (W)	Power Input (W)	Capacity (W)	Power Input (W)	Capacity (W)	Power Input (W)
Outlet Water Temp. ($^{\circ}\text{C}$)	-10	127,204	42,066	124,524	47,769	124,524	54,472	121,852	62,360	115,075	68,120	98,933	68,120	77,711	57,077
	-5	166,233	49,475	162,730	56,183	162,730	64,066	147,897	68,120	127,861	68,120	109,925	68,120	101,554	67,131
	0	196,530	52,704	196,530	61,067	192,250	68,120	164,330	68,120	142,068	68,120	122,139	68,120	114,501	68,120
	5	209,040	44,564	209,040	51,698	209,040	59,024	205,855	68,120	177,569	68,120	152,302	68,120	139,747	66,668
	7	209,040	41,754	209,040	48,568	209,040	55,598	209,040	65,409	187,063	68,120	158,929	68,120	147,620	67,463
	9	209,040	40,880	209,040	47,208	209,040	53,651	209,040	62,466	197,933	68,120	171,557	68,120	153,253	64,687
	11	209,040	40,042	209,040	45,924	209,040	51,835	209,040	59,777	208,798	68,120	182,098	68,120	158,887	62,719
	13	209,040	39,169	209,040	44,728	209,040	50,269	209,040	57,632	209,040	65,378	191,346	68,120	163,785	61,154
	15	209,040	38,313	209,040	43,558	209,040	48,744	209,040	55,558	209,040	62,674	198,588	67,277	167,194	59,189
	20	209,040	36,745	209,040	41,193	209,040	45,476	209,040	50,911	209,040	56,476	198,588	58,406	175,370	55,071

Air-Cooled Scroll Chiller (R410A)

4. Performance Data

■ ACAH067HETB ($\Delta T = 5^{\circ}\text{C}$)

Flow Rate		Outdoor Temperature ($^{\circ}\text{C}$)													
		-15		-10		-5		0		5		10		15	
633 LPM		Capacity (W)	Power Input (W)	Capacity (W)	Power Input (W)	Capacity (W)	Power Input (W)	Capacity (W)	Power Input (W)	Capacity (W)	Power Input (W)	Capacity (W)	Power Input (W)	Capacity (W)	Power Input (W)
Outlet Water Temp. ($^{\circ}\text{C}$)	-10	142,644	39,824	142,644	39,888	142,644	40,145	142,644	40,383	142,644	40,898	142,644	44,065	137,349	48,124
	-5	169,111	42,492	169,111	42,560	169,111	42,834	169,111	43,089	169,111	43,638	169,111	47,017	169,111	53,530
	0	198,113	44,801	198,113	44,873	198,113	45,162	198,113	45,430	198,113	46,009	198,113	49,573	198,113	56,439
	5	222,000	39,809	222,000	39,876	222,000	40,133	222,000	40,373	222,000	40,890	222,000	44,077	222,000	50,223
	7	222,000	37,095	222,000	37,163	222,000	37,403	222,000	37,629	222,000	38,118	222,000	41,128	222,000	46,948
	9	222,000	36,860	222,000	36,919	222,000	37,157	222,000	37,375	222,000	37,843	222,000	40,723	222,000	46,257
	11	222,000	36,619	222,000	36,678	222,000	36,915	222,000	37,124	222,000	37,571	222,000	40,325	222,000	45,587
	13	222,000	36,148	222,000	36,206	222,000	36,439	222,000	36,641	222,000	37,072	222,000	39,722	222,000	44,767
	15	222,000	35,688	222,000	35,745	222,000	35,976	222,000	36,171	222,000	36,585	222,000	39,132	222,000	43,962
	20	222,000	35,282	222,000	35,338	222,000	35,566	222,000	35,745	222,000	36,117	222,000	38,410	222,000	42,707

Flow Rate		Outdoor Temperature ($^{\circ}\text{C}$)													
		20		25		30		35		40		45		48	
633 LPM		Capacity (W)	Power Input (W)	Capacity (W)	Power Input (W)	Capacity (W)	Power Input (W)	Capacity (W)	Power Input (W)	Capacity (W)	Power Input (W)	Capacity (W)	Power Input (W)	Capacity (W)	Power Input (W)
Outlet Water Temp. ($^{\circ}\text{C}$)	-10	135,090	54,988	132,244	62,443	132,244	71,204	129,406	81,515	113,669	71,414	94,721	69,018	72,854	56,626
	-5	169,111	61,952	169,111	71,865	169,111	81,949	152,199	86,285	148,545	83,992	123,783	81,175	95,207	66,600
	0	198,113	65,394	198,113	75,771	197,843	86,285	169,110	86,285	169,555	86,285	145,012	85,587	111,535	70,220
	5	222,000	58,252	222,000	67,578	222,000	77,154	211,843	86,285	200,850	81,776	166,860	78,977	131,012	66,141
	7	222,000	54,580	222,000	63,486	222,000	72,677	222,000	85,351	201,854	78,013	175,743	79,713	138,393	66,930
	9	222,000	53,437	222,000	61,709	222,000	70,131	222,000	81,654	202,859	74,096	179,529	75,437	143,675	64,176
	11	222,000	52,342	222,000	60,030	222,000	67,757	222,000	78,139	204,867	70,936	183,316	72,569	148,956	62,224
	13	222,000	51,201	222,000	58,467	222,000	65,710	222,000	75,335	210,893	70,002	186,609	70,302	153,549	60,671
	15	222,000	50,082	222,000	56,938	222,000	63,716	222,000	72,624	222,000	79,825	187,103	67,078	156,745	58,722
	20	222,000	48,031	222,000	53,846	222,000	59,445	222,000	66,550	222,000	71,931	187,103	58,233	164,409	54,636

Air-Cooled Scroll Chiller (R410A)

4. Performance Data

■ ACAH067HETB ($\Delta T = 7^{\circ}\text{C}$)

Flow Rate		Outdoor Temperature ($^{\circ}\text{C}$)													
		-15		-10		-5		0		5		10		15	
468 LPM		Capacity (W)	Power Input (W)	Capacity (W)	Power Input (W)	Capacity (W)	Power Input (W)	Capacity (W)	Power Input (W)	Capacity (W)	Power Input (W)	Capacity (W)	Power Input (W)	Capacity (W)	Power Input (W)
Outlet Water Temp. ($^{\circ}\text{C}$)	-10	146,780	40,023	146,780	40,087	146,780	40,346	146,780	40,585	146,780	41,102	146,780	44,286	141,332	48,365
	-5	174,015	42,704	174,015	42,773	174,015	43,049	174,015	43,304	174,015	43,856	174,015	47,253	174,015	53,798
	0	203,858	45,025	203,858	45,097	203,858	45,388	203,858	45,657	203,858	46,239	203,858	49,821	203,858	56,721
	5	228,438	40,008	228,438	40,075	228,438	40,334	228,438	40,575	228,438	41,095	228,438	44,297	228,438	50,474
	7	228,438	37,281	228,438	37,349	228,438	37,590	228,438	37,817	228,438	38,309	228,438	41,334	228,438	47,182
	9	228,438	37,044	228,438	37,104	228,438	37,343	228,438	37,562	228,438	38,032	228,438	40,926	228,438	46,488
	11	228,438	36,802	228,438	36,861	228,438	37,099	228,438	37,309	228,438	37,759	228,438	40,527	228,438	45,815
	13	228,438	36,328	228,438	36,387	228,438	36,621	228,438	36,824	228,438	37,257	228,438	39,921	228,438	44,991
	15	228,438	35,866	228,438	35,924	228,438	36,155	228,438	36,351	228,438	36,768	228,438	39,327	228,438	44,182
	20	228,438	35,458	228,438	35,515	228,438	35,744	228,438	35,923	228,438	36,298	228,438	38,602	228,438	42,921

Flow Rate		Outdoor Temperature ($^{\circ}\text{C}$)													
		20		25		30		35		40		45		48	
468 LPM		Capacity (W)	Power Input (W)	Capacity (W)	Power Input (W)	Capacity (W)	Power Input (W)	Capacity (W)	Power Input (W)	Capacity (W)	Power Input (W)	Capacity (W)	Power Input (W)	Capacity (W)	Power Input (W)
Outlet Water Temp. ($^{\circ}\text{C}$)	-10	139,008	55,263	136,079	62,755	136,079	71,560	133,159	81,922	116,966	71,771	97,468	69,363	74,967	56,910
	-5	174,015	62,262	174,015	72,225	174,015	82,359	155,834	86,285	152,853	84,412	127,373	81,581	97,968	66,933
	0	203,858	65,721	203,858	76,150	202,567	86,285	173,148	86,285	173,604	86,285	149,217	86,015	114,770	70,571
	5	228,438	58,543	228,438	67,916	228,438	77,540	216,902	86,285	206,675	82,185	171,699	79,372	134,812	66,472
	7	228,438	54,853	228,438	63,804	228,438	73,040	228,438	85,777	207,708	78,404	180,839	80,112	142,407	67,265
	9	228,438	53,704	228,438	62,018	228,438	70,481	228,438	82,063	208,741	74,467	184,736	75,814	147,841	64,497
	11	228,438	52,604	228,438	60,330	228,438	68,096	228,438	78,530	210,808	71,290	188,632	72,932	153,276	62,535
	13	228,438	51,457	228,438	58,759	228,438	66,039	228,438	75,712	217,008	70,352	192,020	70,654	158,002	60,975
	15	228,438	50,332	228,438	57,222	228,438	64,035	228,438	72,987	228,438	80,224	192,528	67,413	161,290	59,015
	20	228,438	48,272	228,438	54,115	228,438	59,743	228,438	66,882	228,438	72,291	192,528	58,524	169,177	54,909

Air-Cooled Scroll Chiller (R410A)

4. Performance Data

■ ACAH067HETB ($\Delta T = 10^{\circ}\text{C}$)

Flow Rate		Outdoor Temperature ($^{\circ}\text{C}$)													
		-15		-10		-5		0		5		10		15	
341 LPM		Capacity (W)	Power Input (W)	Capacity (W)	Power Input (W)	Capacity (W)	Power Input (W)	Capacity (W)	Power Input (W)	Capacity (W)	Power Input (W)	Capacity (W)	Power Input (W)	Capacity (W)	Power Input (W)
Outlet Water Temp. ($^{\circ}\text{C}$)	-10	152,914	40,342	152,914	40,406	152,914	40,667	152,914	40,908	152,914	41,430	152,914	44,638	147,238	48,750
	-5	181,287	43,044	181,287	43,113	181,287	43,391	181,287	43,649	181,287	44,205	181,287	47,629	181,287	54,226
	0	212,377	45,383	212,377	45,456	212,377	45,749	212,377	46,021	212,377	46,607	212,377	50,217	212,377	57,173
	5	237,984	40,327	237,984	40,394	237,984	40,655	237,984	40,898	237,984	41,422	237,984	44,650	237,984	50,876
	7	237,984	37,578	237,984	37,646	237,984	37,890	237,984	38,118	237,984	38,613	237,984	41,663	237,984	47,558
	9	237,984	37,339	237,984	37,399	237,984	37,640	237,984	37,861	237,984	38,335	237,984	41,252	237,984	46,858
	11	237,984	37,095	237,984	37,155	237,984	37,394	237,984	37,606	237,984	38,060	237,984	40,849	237,984	46,179
	13	237,984	36,618	237,984	36,676	237,984	36,913	237,984	37,118	237,984	37,554	237,984	40,239	237,984	45,349
	15	237,984	36,152	237,984	36,210	237,984	36,443	237,984	36,641	237,984	37,060	237,984	39,640	237,984	44,534
	20	237,984	35,740	237,984	35,798	237,984	36,029	237,984	36,209	237,984	36,586	237,984	38,910	237,984	43,262

Flow Rate		Outdoor Temperature ($^{\circ}\text{C}$)													
		20		25		30		35		40		45		48	
341 LPM		Capacity (W)	Power Input (W)	Capacity (W)	Power Input (W)	Capacity (W)	Power Input (W)	Capacity (W)	Power Input (W)	Capacity (W)	Power Input (W)	Capacity (W)	Power Input (W)	Capacity (W)	Power Input (W)
Outlet Water Temp. ($^{\circ}\text{C}$)	-10	144,817	55,702	141,765	63,254	141,765	72,130	138,724	82,574	121,853	72,342	101,541	69,916	78,100	57,363
	-5	181,287	62,757	181,287	72,800	181,287	83,014	161,063	86,285	159,240	85,084	132,696	82,230	102,062	67,466
	0	212,377	66,244	212,377	76,756	209,366	86,285	178,959	86,285	179,430	86,285	154,710	86,285	119,566	71,133
	5	237,984	59,009	237,984	68,456	237,984	78,157	224,182	86,285	215,311	82,839	178,874	80,004	140,445	67,001
	7	237,984	55,290	237,984	64,312	237,984	73,621	237,501	86,285	216,388	79,028	188,396	80,749	148,358	67,800
	9	237,984	54,132	237,984	62,511	237,984	71,042	237,984	82,716	217,464	75,059	192,455	76,418	154,019	65,010
	11	237,984	53,023	237,984	60,811	237,984	68,638	237,984	79,155	219,617	71,858	196,515	73,512	159,681	63,033
	13	237,984	51,867	237,984	59,227	237,984	66,564	237,984	76,314	226,077	70,912	200,044	71,216	164,604	61,460
	15	237,984	50,733	237,984	57,678	237,984	64,545	237,984	73,568	237,984	80,863	200,574	67,950	168,030	59,485
	20	237,984	48,656	237,984	54,546	237,984	60,218	237,984	67,415	237,984	72,866	200,574	58,990	176,246	55,346

Air-Cooled Scroll Chiller (R410A)

5. Head loss of Cold water

■ A(C)CAH Series evaporator head loss graph

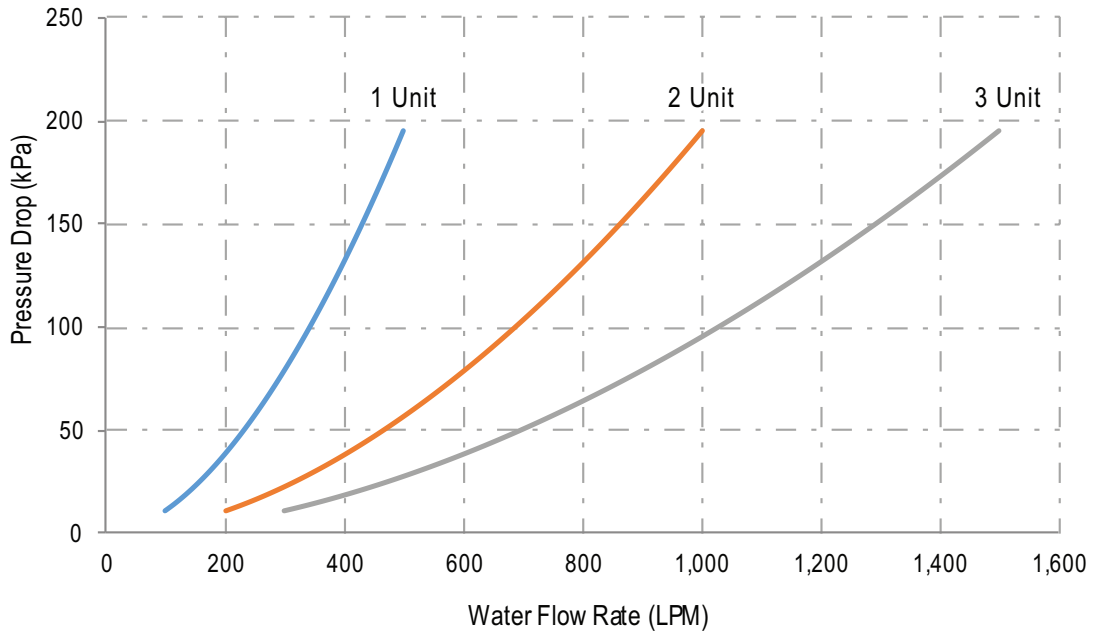

* LPM : Liter Per Minute

Air-Cooled Scroll Chiller (R410A)

6. Dimensions

■ 1 Unit

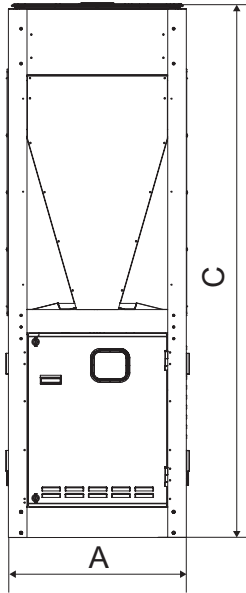

Front view

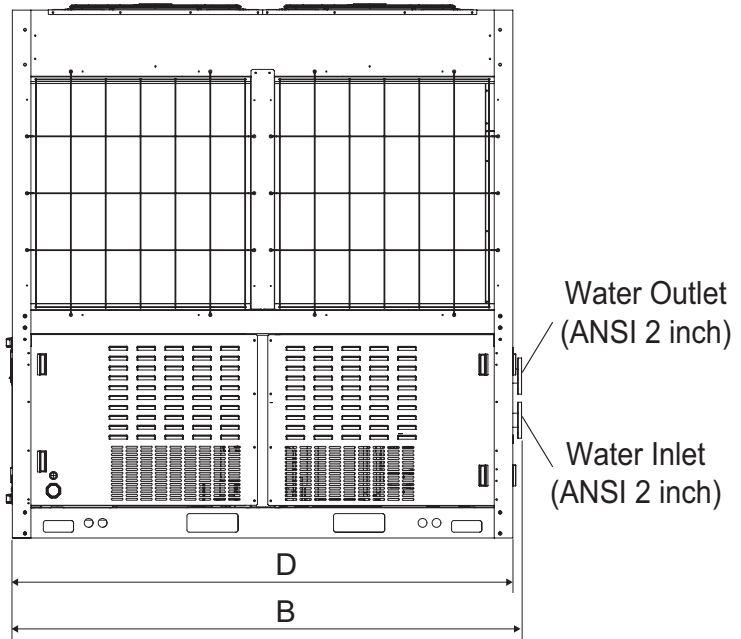

Side view

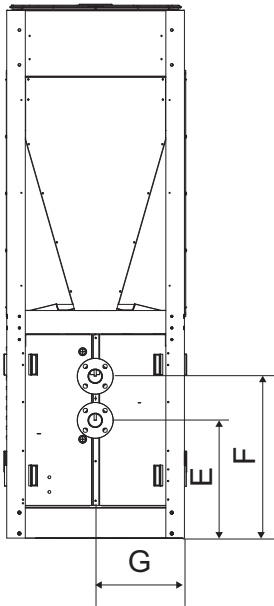

Rear view

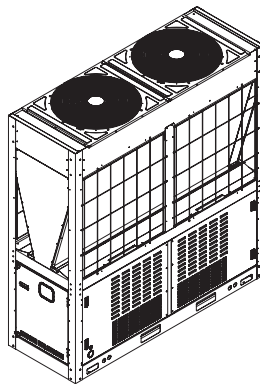

(Unit : mm)

Classification	Dimension
A	765
B	2,198
C	2,200
D	2,154
E	507
F	700
G	384

Air-Cooled Scroll Chiller (R410A)

6. Dimensions

■ 2 Unit

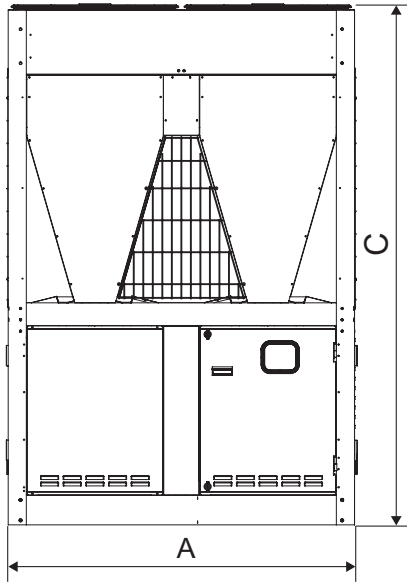

Front view

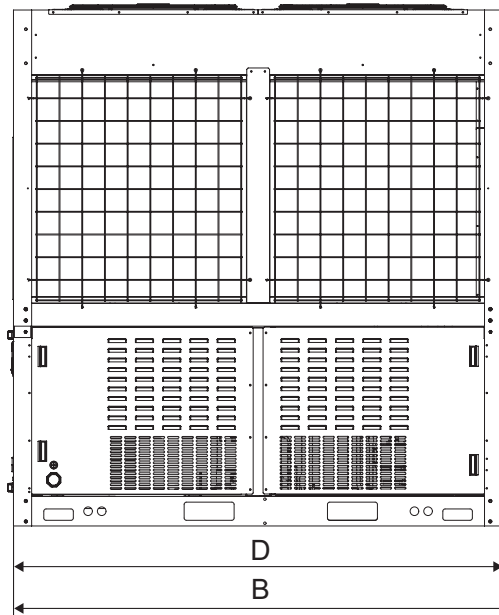

Side view

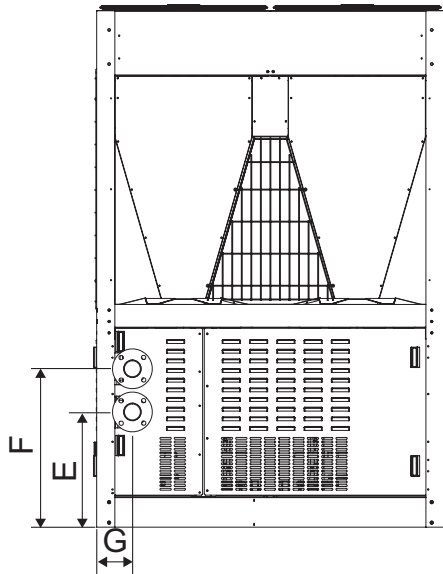

Rear view

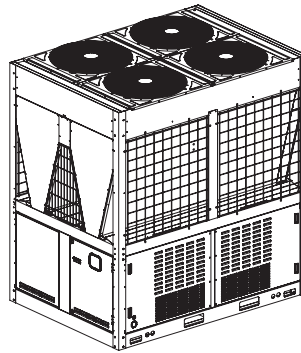

(Unit : mm)

Classification	Dimension
A	1,528
B	2,199
C	2,200
D	2,154
E	434
F	697
G	157

Air-Cooled Scroll Chiller (R410A)

6. Dimensions

■ 3 Unit

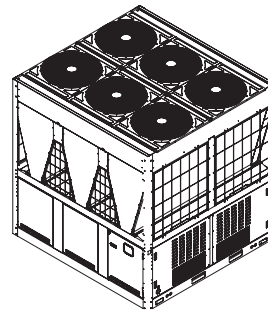
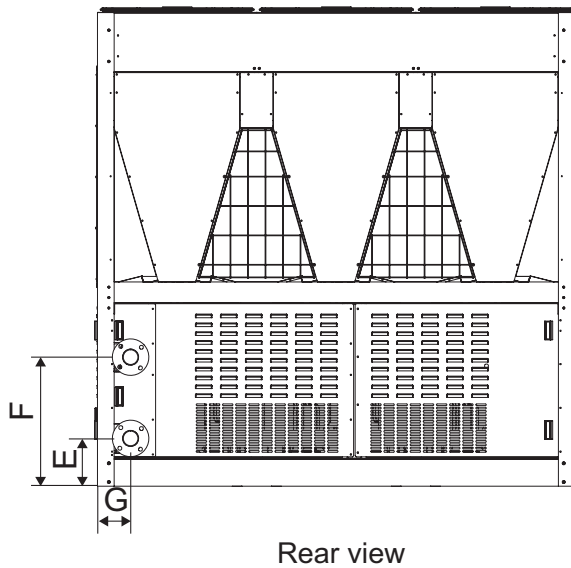
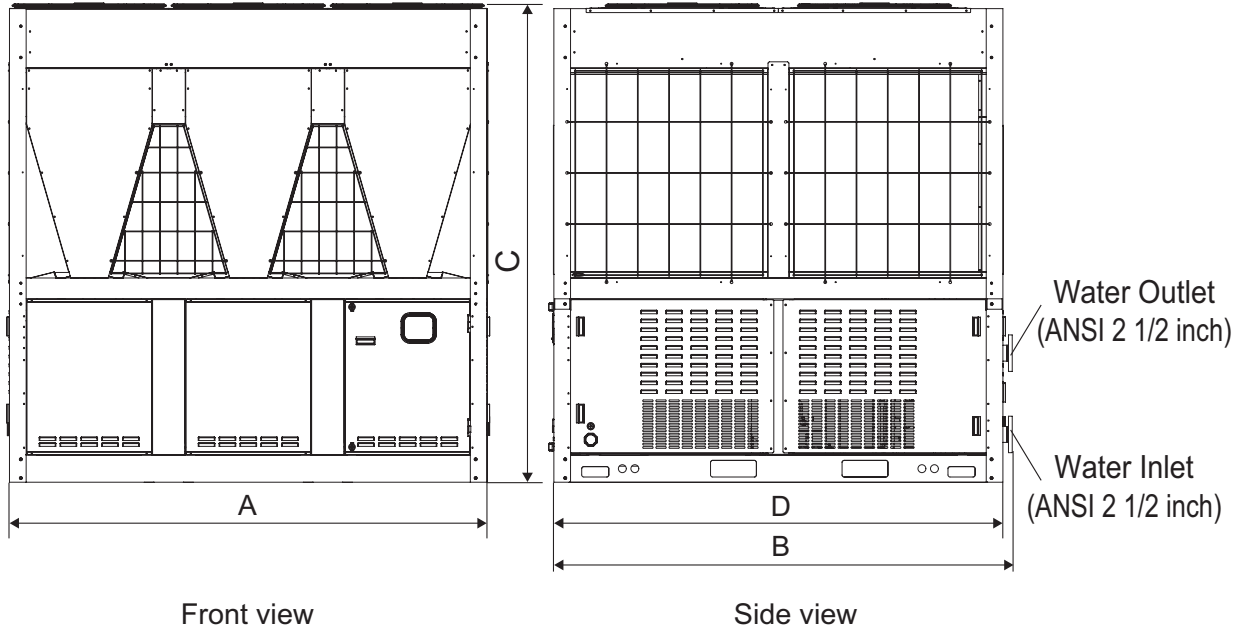

(Unit : mm)

Classification	Dimension
A	2 291
B	2 199
C	2 193
D	2 154
E	230
F	619
G	158.8

Air-Cooled Scroll Chiller (R410A)

7. Base of Installation

■ Details to consider when installing the base

- The base must be able to withstand concentrated load.
- The base must be installed with maximum gradient of 1/300.
- The height of the base must be higher than the surface of the water and drain holes must be installed around.
- Set the height of the base according to the installation environment so that the product is not submersed in water. The default height of the base is 200mm and it must be at least doubled in areas with double the snowfall of 100mm or above.
- Install the drain pipe in the drain hole.
The drainage must be finished so that particles around the drainage do not clog the pipes.
- LG is not responsible for product failure or damage from incorrectly designed or manufactured base.

• Shape of anchor bolt

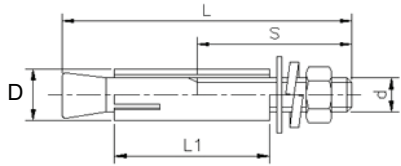

• Specification of anchor bolt

Screw size (d)	L	S	D	L1	Used drill	Depth of drill (min.)	Pullout load (N)
15.88mm(M16)	125	70	22	65	22	65	42,140

• Dimension

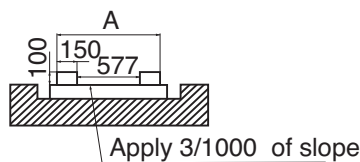
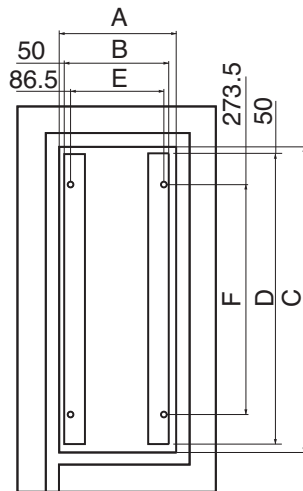

< 1 Unit Drawing of base >

• Shape of anchor bolt (Unit : mm)

	1 Unit	2 Unit	3 Unit
A	865	1,628	2,391
B	765	1,528	2,291
C	2,254	2,254	2,254
D	2,154	2,154	2,154
E	691	1,456	2,217
F	1,707	1,707	1,707

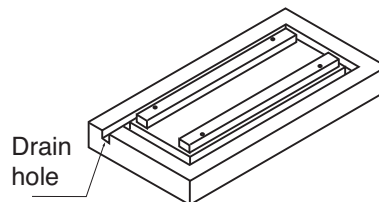

Air-Cooled Scroll Chiller (R410A)

7. Base of Installation

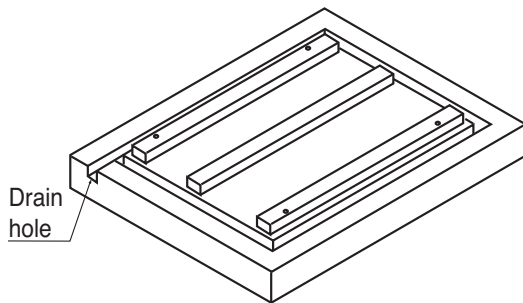
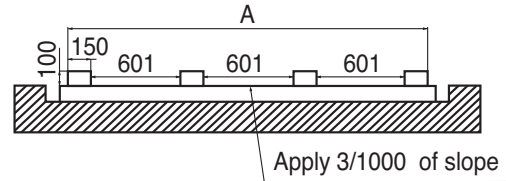
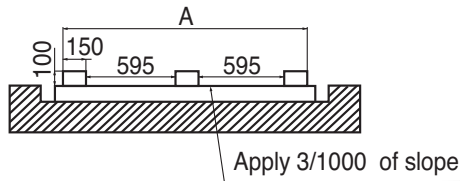
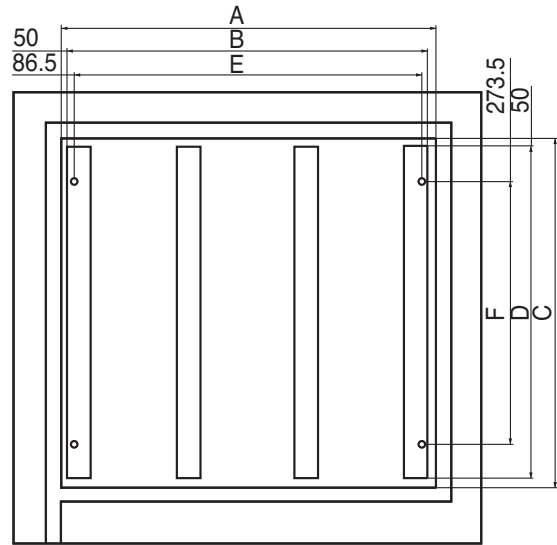
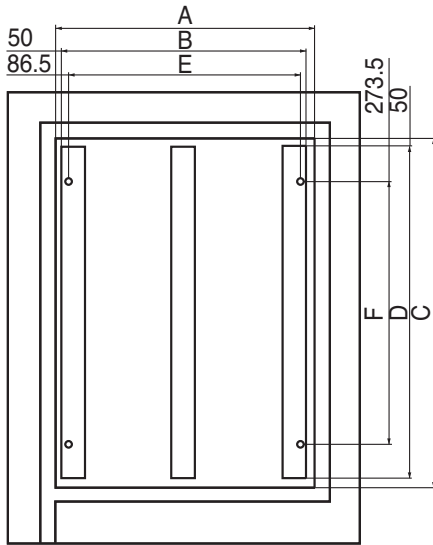

< 2 Unit Drawing of base >

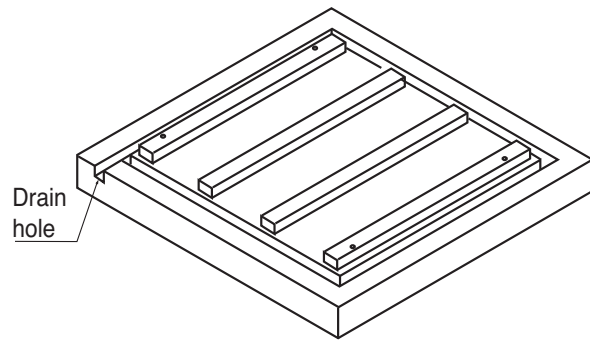

< 3 Unit Drawing of base >

Air-Cooled Scroll Chiller (R410A)

8. Electric Characteristics

Electric specification

ACAH	Unit		Power Supply		COMP		OFM	
	Voltage	Voltage range	MCA	MFA	MSC	RLA	kW	FLA
020VETB	208 - 230	Min. : 187, Max. : 253	72.9	100	20.4	57.5	1.8	8
033VETB	208 - 230	Min. : 187, Max. : 253	117.4	125	40.8	95.2	3.6	16
040VETB	208 - 230	Min. : 187, Max. : 253	138.4	150	40.8	115.0	3.6	16
050VETB	208 - 230	Min. : 187, Max. : 253	117.4+61.8	125+80	40.7+20.4	95.2+47.6	3.6+1.8	16+8
060VETB	208 - 230	Min. : 187, Max. : 253	138.4+72.9	150+100	40.7+20.4	115.0+57.5	3.6+1.8	16+8
020LETB	380 - 415	Min. : 342, Max. : 456	39	60	11.8	30.2	1.8	5
023LETB	380 - 415	Min. : 342, Max. : 456	48	60	11.8	38.2	1.8	5
033LETB	380 - 415	Min. : 342, Max. : 456	72*	100	23.6	55.2	3.6	10
040LETB	380 - 415	Min. : 342, Max. : 456	78	100	23.6	60.4	3.6	10
045LETB	380 - 415	Min. : 342, Max. : 456	96	125	23.6	76.4	3.6	10
050LETB	380 - 415	Min. : 342, Max. : 456	108	125	35.4	82.8	5.4	15
060LETB	380 - 415	Min. : 342, Max. : 456	117	125	35.4	90.6	5.4	15
067LETB	380 - 415	Min. : 342, Max. : 456	144	200	35.4	114.6	5.4	15
020HETB	460	Min. : 414, Max. : 506	31.0	40	9.7	24.9	1.8	5
023HETB	460	Min. : 414, Max. : 506	41.2	50	9.7	31.6	1.8	5
033HETB	460	Min. : 414, Max. : 506	48.4	50	19.5	45.6	3.6	10
040HETB	460	Min. : 414, Max. : 506	59.0	70	19.5	49.9	3.6	10
045HETB	460	Min. : 414, Max. : 506	78.2	90	19.5	63.1	3.6	10
050HETB	460	Min. : 414, Max. : 506	71.4	80	29.2	68.4	5.4	15
060HETB	460	Min. : 414, Max. : 506	87.0	90	29.2	74.8	5.4	15
067HETB	460	Min. : 414, Max. : 506	115.2	125	29.2	94.7	5.4	15

Notes:

1. RLA is the current required when operated in the following condition.
Cooling : Outdoor air temp. 27°C DB / 19.0°C WB,
Water inlet / Outlet temp. 12°C / 7°C
Heating : Outdoor air temp. 7°C DB / 6.0°C WB,
Water inlet / Outlet temp. 40.0°C / 45.0°C
 2. Voltage range
The chiller must be operated at the voltage within the upper and lower limit supplied from the power terminal to operate normally.
 3. Maximum voltage variance permitted between phases is 2%.
 4. MCA is the criteria of selecting the wiring standard.
 5. MFA is used when selecting circuit breaker and grounding error circuit breaker (Electricity leakage circuit breaker).
- * For Russia only, MCA of ACAH033LETB is 76.

<p>MCA: Minimum Circuit Ampere, A MFA: Maximum Fuse Ampere, A RLA: Rated Load Ampere, A MSC: Maximum Start Current, A</p>

Air-Cooled Scroll Chiller (R410A)

9. Wiring Diagrams

A(C)CAH***VETB

■ 1 UNIT, 2 UNIT (Main), 3 UNIT (Main)

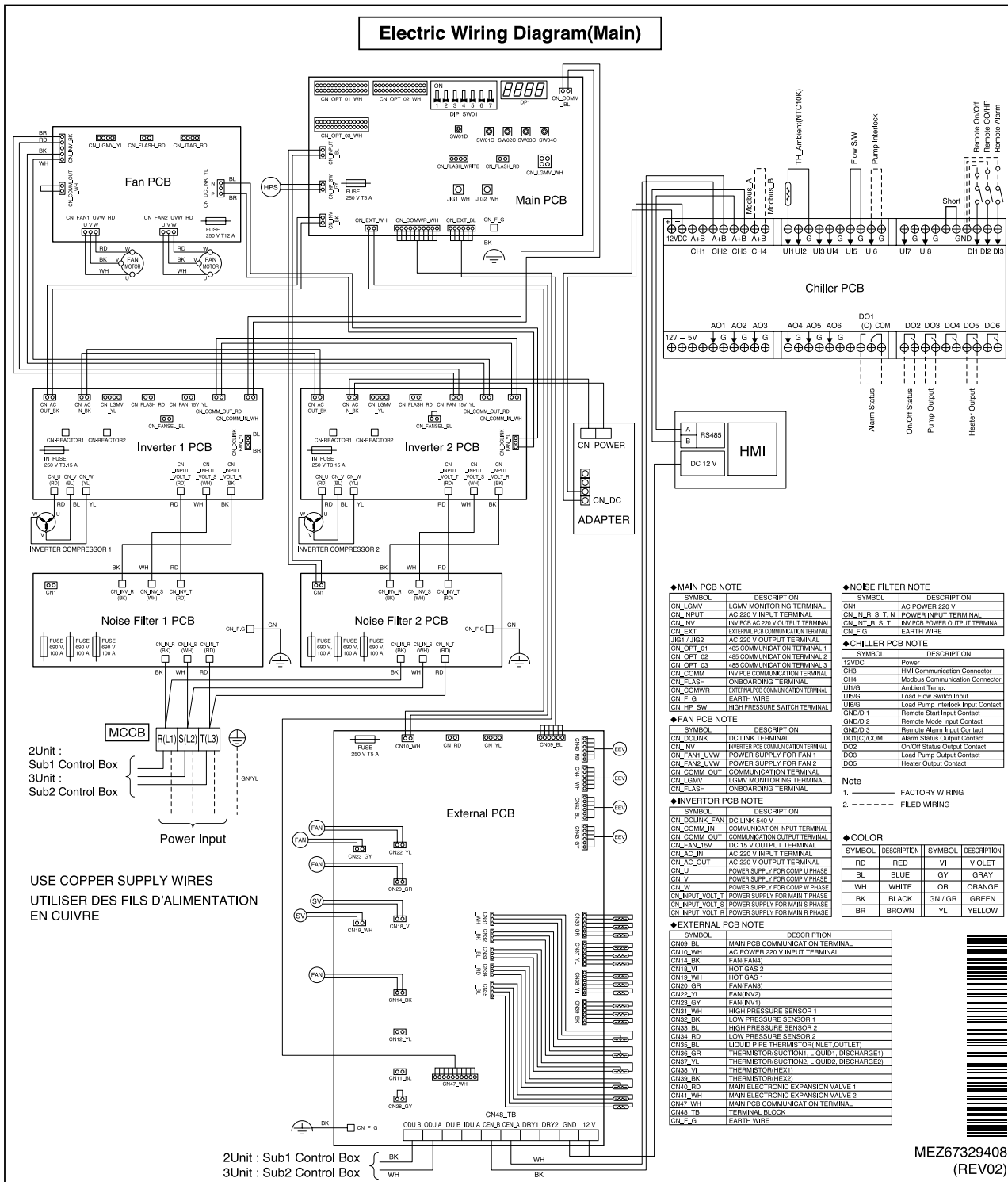

MEZ67329408
(REV02)

Air-Cooled Scroll Chiller (R410A)

9. Wiring Diagrams

2 UNIT (Sub), 3 UNIT (Sub1, Sub2)

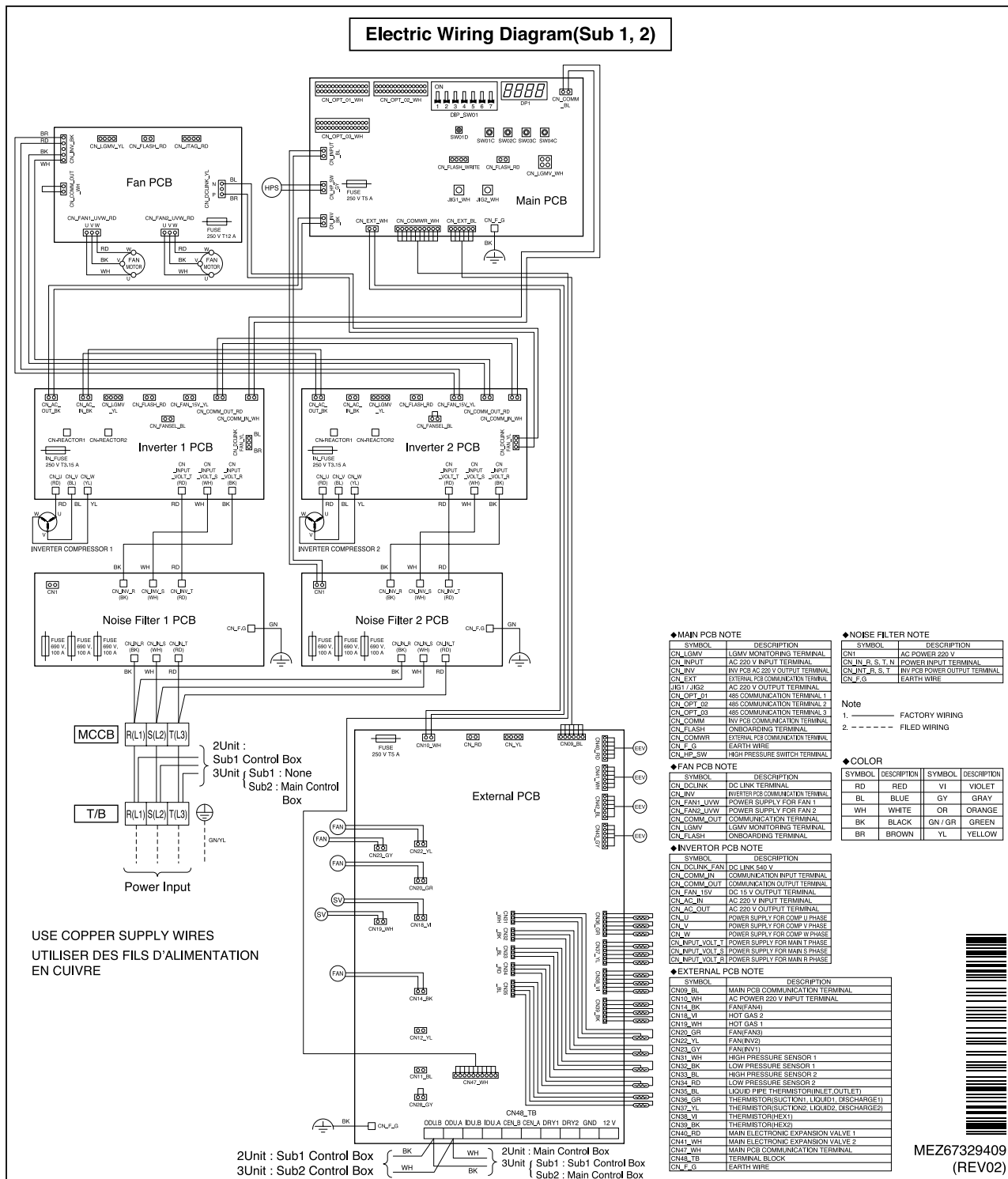

◆MAIN PCB NOTE

SYMBOL	DESCRIPTION
CN_LGMV	LGMV MONITORING TERMINAL
CN_INPT	AC 220 V INPUT TERMINAL
CN_INV	INV PCB AC 220 V OUTPUT TERMINAL
CN_EXT	EXTERNAL PCB COMMUNICATION TERMINAL
HIGH_4852	AC 220 V OUTPUT TERMINAL
CN_OPT_01	485 COMMUNICATION TERMINAL 1
CN_OPT_02	485 COMMUNICATION TERMINAL 2
CN_OPT_03	485 COMMUNICATION TERMINAL 3
CN_COMM	INV PCB COMMUNICATION TERMINAL
CN_FLASH	ONBOARDING TERMINAL
CN_COMMW	EXTERNAL PCB COMMUNICATION TERMINAL
CN_F_G	EARTH WIRE
CN_HP_SW	HIGH PRESSURE SWITCH TERMINAL

◆NOISE FILTER NOTE

SYMBOL	DESCRIPTION
CN1	AC POWER 220 V
CN_INL_R_S_T_N	POWER INPUT TERMINAL
CN_INT_R_S_T	INV PCB POWER OUTPUT TERMINAL
CN_F_G	EARTH WIRE

Note
 1. _____ FACTORY WIRING
 2. - - - - - FILED WIRING

◆FAN PCB NOTE

SYMBOL	DESCRIPTION
CN_DCLNK	DC LINK TERMINAL
CN_INV	INVERTER PCB COMMUNICATION TERMINAL
CN_FAN1_UVW	POWER SUPPLY FOR FAN 1
CN_FAN2_UVW	POWER SUPPLY FOR FAN 2
CN_COMM_OUT	COMMUNICATION TERMINAL
CN_LGMV	LGMV MONITORING TERMINAL
CN_FLASH	ONBOARDING TERMINAL

◆COLOR

SYMBOL	DESCRIPTION	SYMBOL	DESCRIPTION
RD	RED	VI	VIOLET
BL	BLUE	GY	GRAY
WH	WHITE	OR	ORANGE
BK	BLACK	GN / GR	GREEN
BR	BROWN	YL	YELLOW

◆INVERTOR PCB NOTE

SYMBOL	DESCRIPTION
CN_DCLNK_FAN	DC LINK 540 V
CN_COMM_IN	COMMUNICATION INPUT TERMINAL
CN_COMM_OUT	COMMUNICATION OUTPUT TERMINAL
CN_FAN_15V	DC 15 V OUTPUT TERMINAL
CN_AC_IN	AC 220 V INPUT TERMINAL
CN_AC_OUT	AC 220 V OUTPUT TERMINAL
CN_U	POWER SUPPLY FOR COMP U PHASE
CN_V	POWER SUPPLY FOR COMP V PHASE
CN_W	POWER SUPPLY FOR COMP W PHASE
CN_INPT_VOLT_I	POWER SUPPLY FOR MAIN T PHASE
CN_INPT_VOLT_L	POWER SUPPLY FOR MAIN S PHASE
CN_INPT_VOLT_R	POWER SUPPLY FOR MAIN R PHASE

◆EXTERNAL PCB NOTE

SYMBOL	DESCRIPTION
CN0_B	MAIN PCB COMMUNICATION TERMINAL
CN0_WH	AC POWER 220 V INPUT TERMINAL
CN0_BK	FAN(FAN)
CN0_VI	HOT GAS 2
CN0S_WH	HOT GAS 1
CN0S_GR	FAN(FAN)
CN0S_VI	FAN(INV)
CN0S_GY	FAN(INV1)
CN01_WH	HIGH PRESSURE SENSOR 1
CN02_BK	LOW PRESSURE SENSOR 1
CN03_BL	HIGH PRESSURE SENSOR 2
CN04_RD	LOW PRESSURE SENSOR 2
CN05_BL	LIQUID PIPE THERMISTOR(INLET OUTLET)
CN06_OR	THERMISTOR(SUCTION1, LIQUID1, DISCHARGE1)
CN07_VI	THERMISTOR(SUCTION2, LIQUID2, DISCHARGE2)
CN08_VI	THERMISTOR(HEX1)
CN09_BK	THERMISTOR(HEX2)
CN00_RD	MAIN ELECTRONIC EXPANSION VALVE 1
CN00_WH	MAIN ELECTRONIC EXPANSION VALVE 2
CN07_WH	MAIN PCB COMMUNICATION TERMINAL
CN04_TB	TERMINAL BLOCK
CN0_F_G	EARTH WIRE

Air-Cooled Scroll Chiller (R410A)

9. Wiring Diagrams

A(C)CAH***LETB

■ 1 UNIT, 2 UNIT (Main), 3 UNIT (Main)

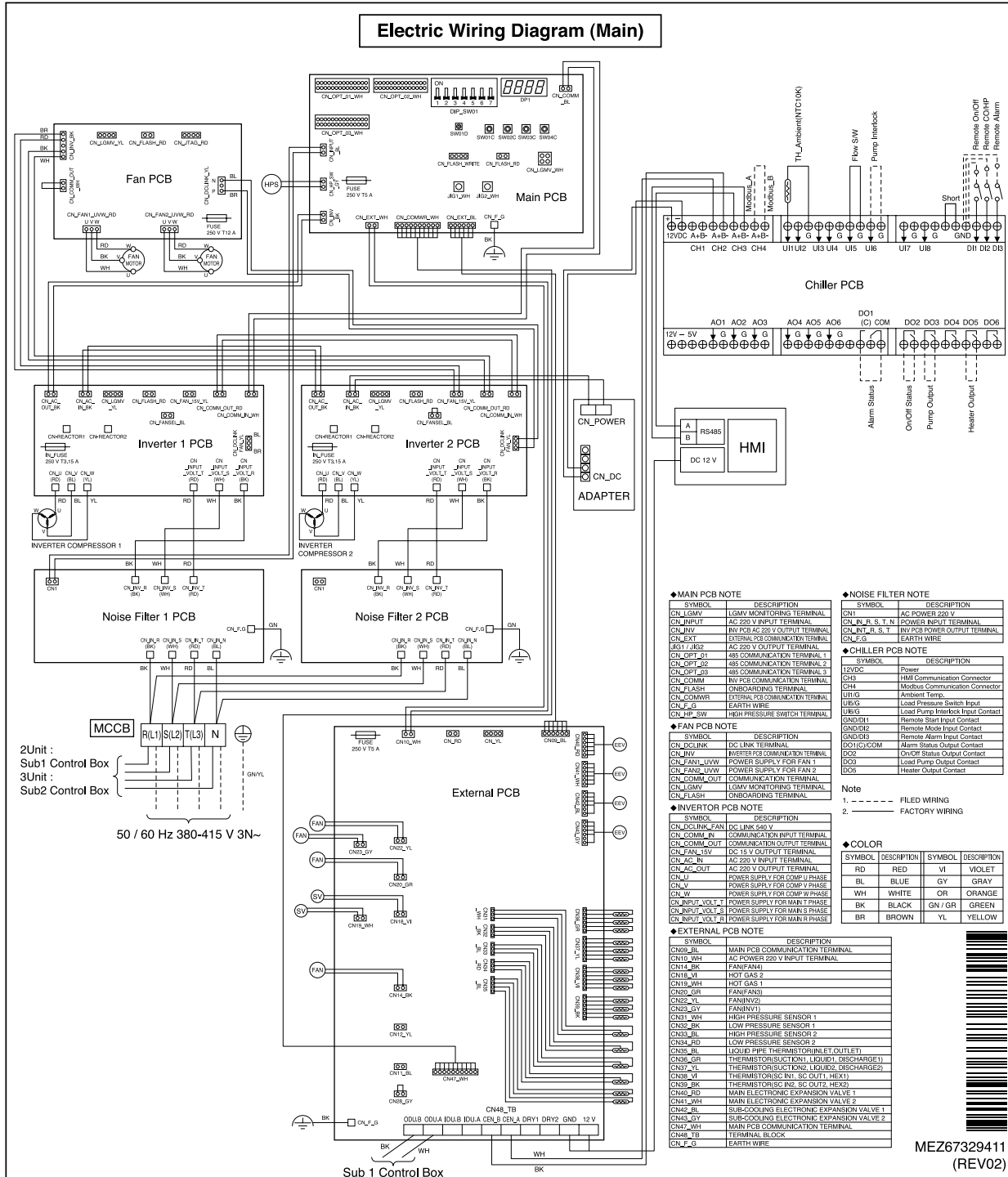

MEZ67329411
(REV02)

Air-Cooled Scroll Chiller (R410A)

9. Wiring Diagrams

2 UNIT (Sub), 3 UNIT (Sub2)

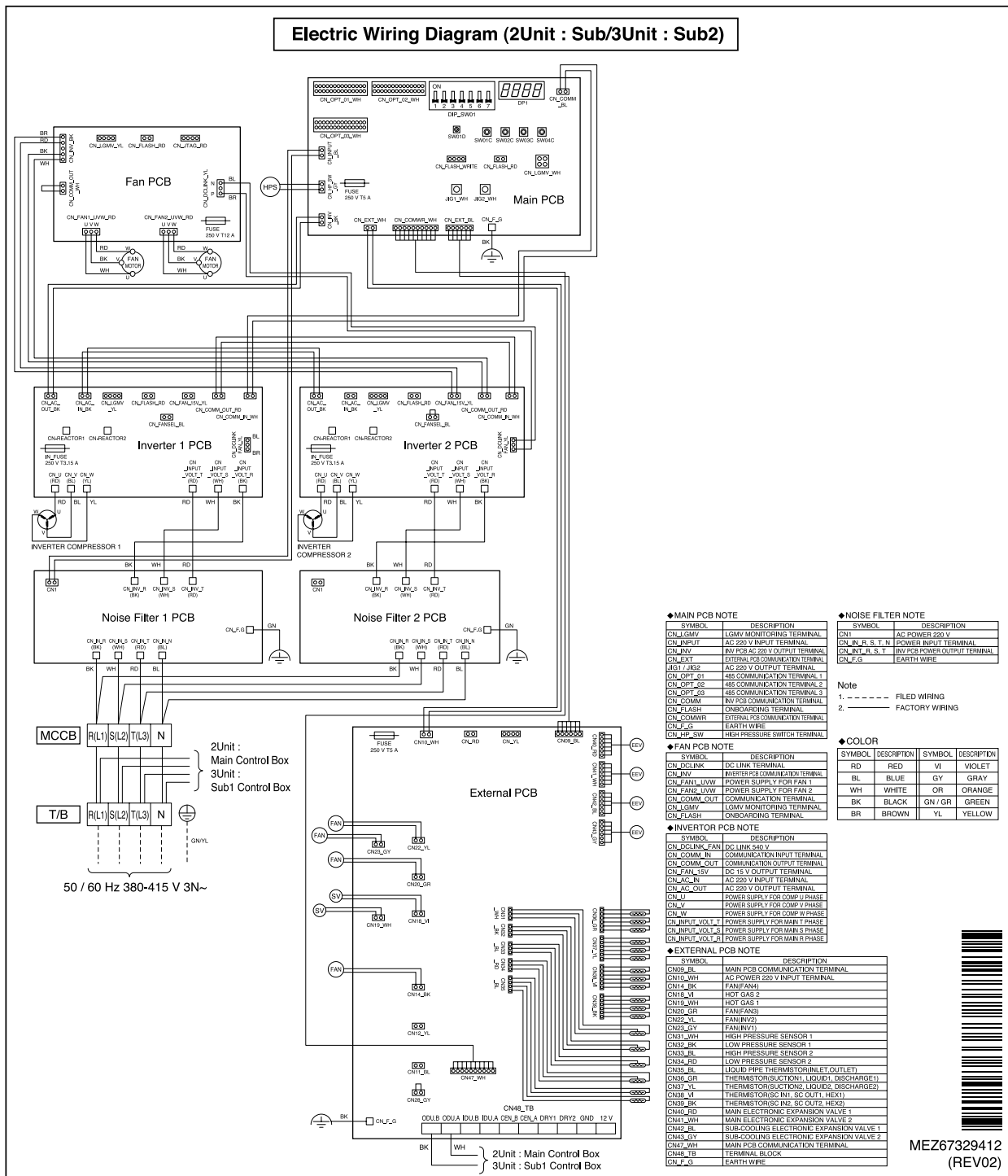

Air-Cooled Scroll Chiller (R410A)

9. Wiring Diagrams

3 UNIT (Sub1)

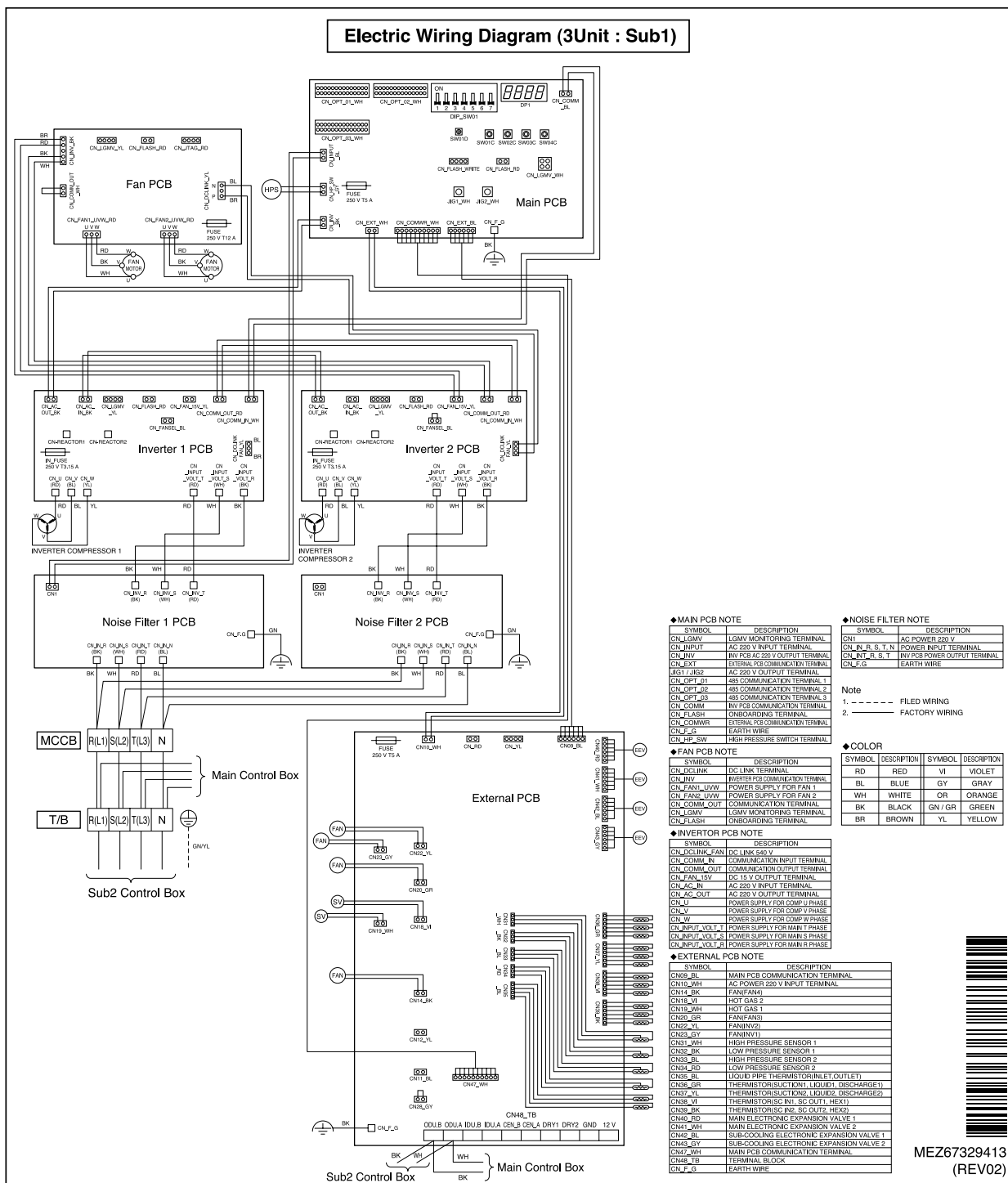

Air-Cooled Scroll Chiller (R410A)

9. Wiring Diagrams

ACAH***HETB

■ 1 UNIT, 2 UNIT (Main), 3 UNIT (Main)

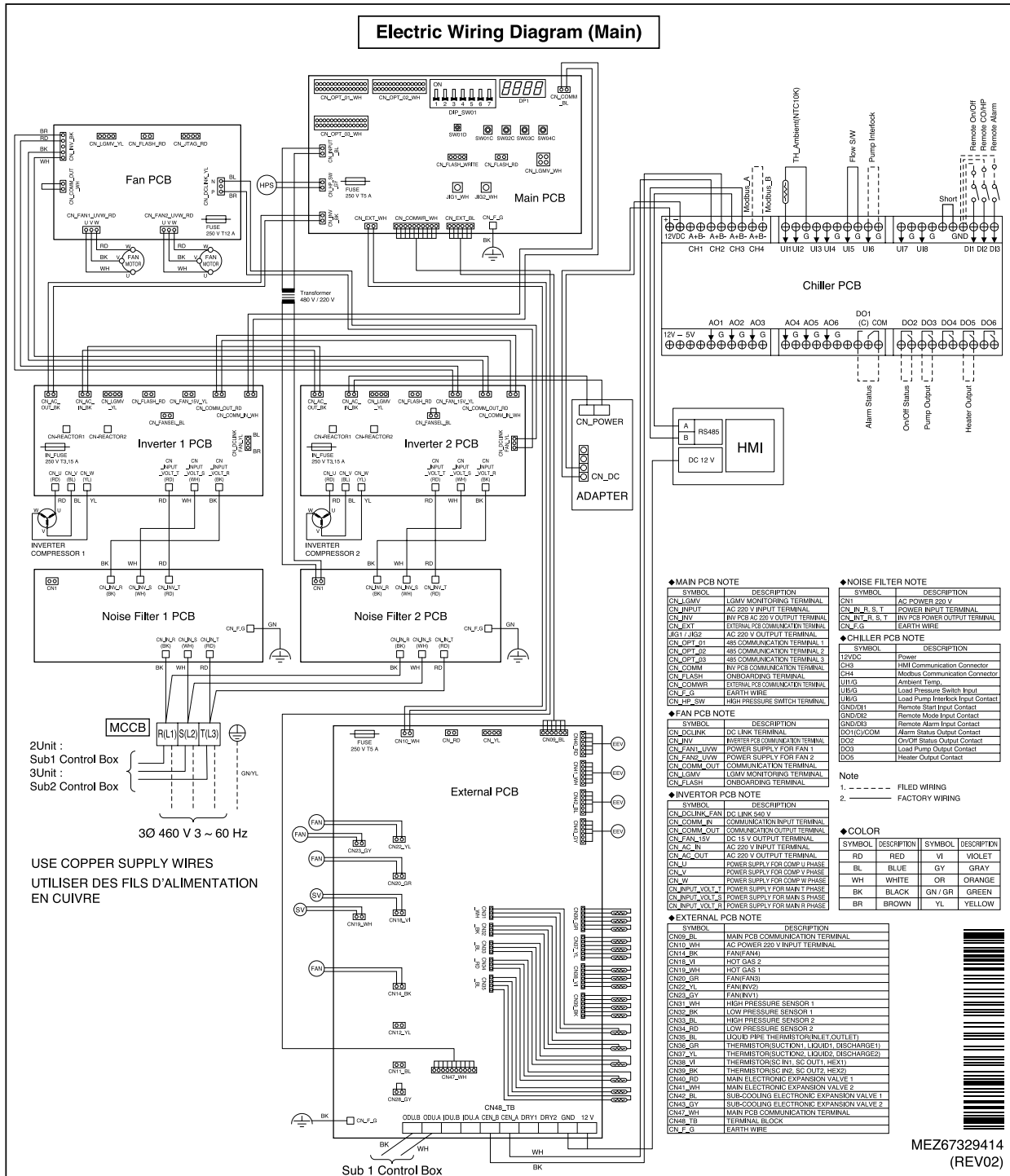

Air-Cooled Scroll Chiller (R410A)

9. Wiring Diagrams

2 UNIT (Sub), 3 UNIT (Sub2)

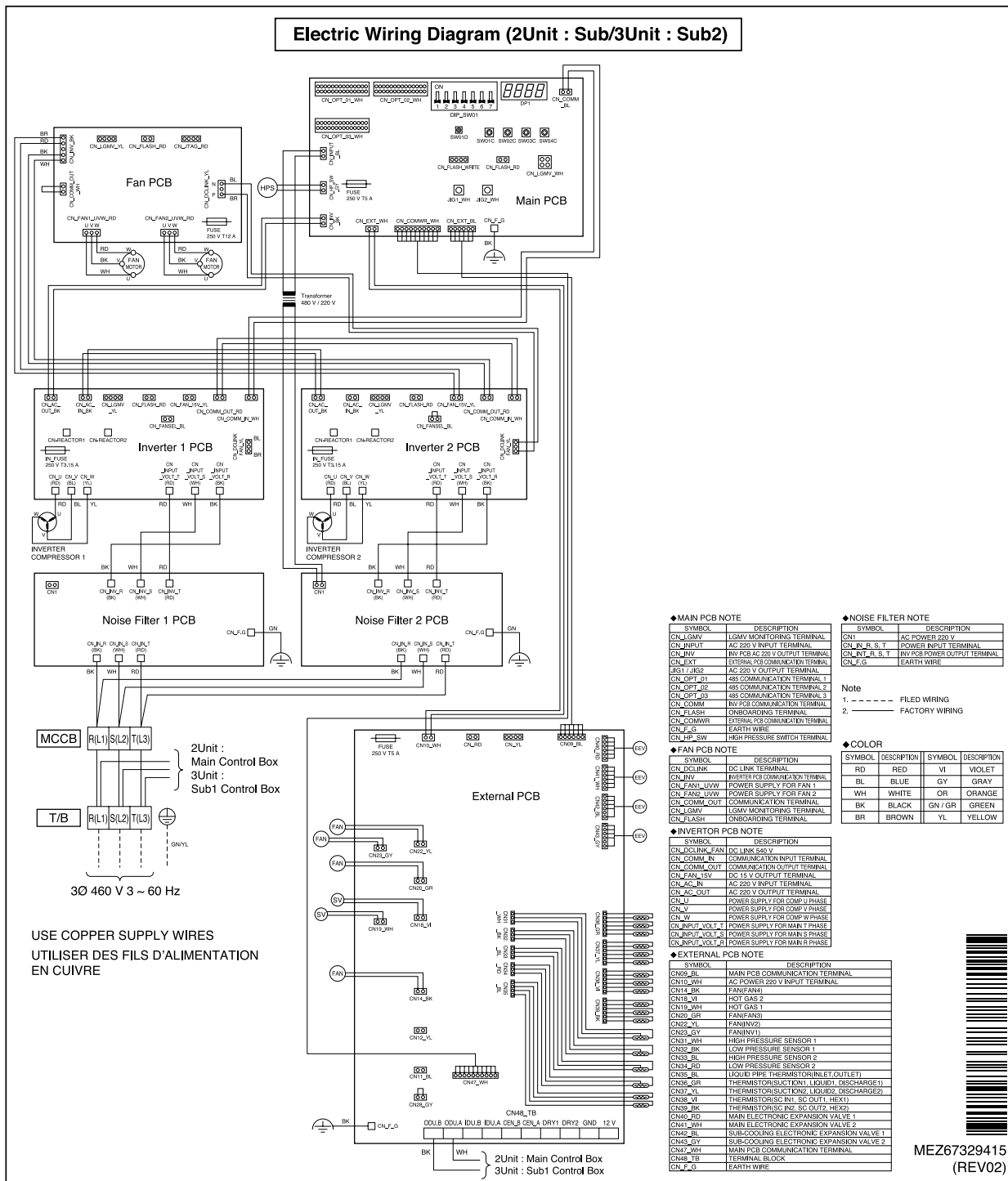

Air-Cooled Scroll Chiller (R410A)

9. Wiring Diagrams

3 UNIT (Sub1)

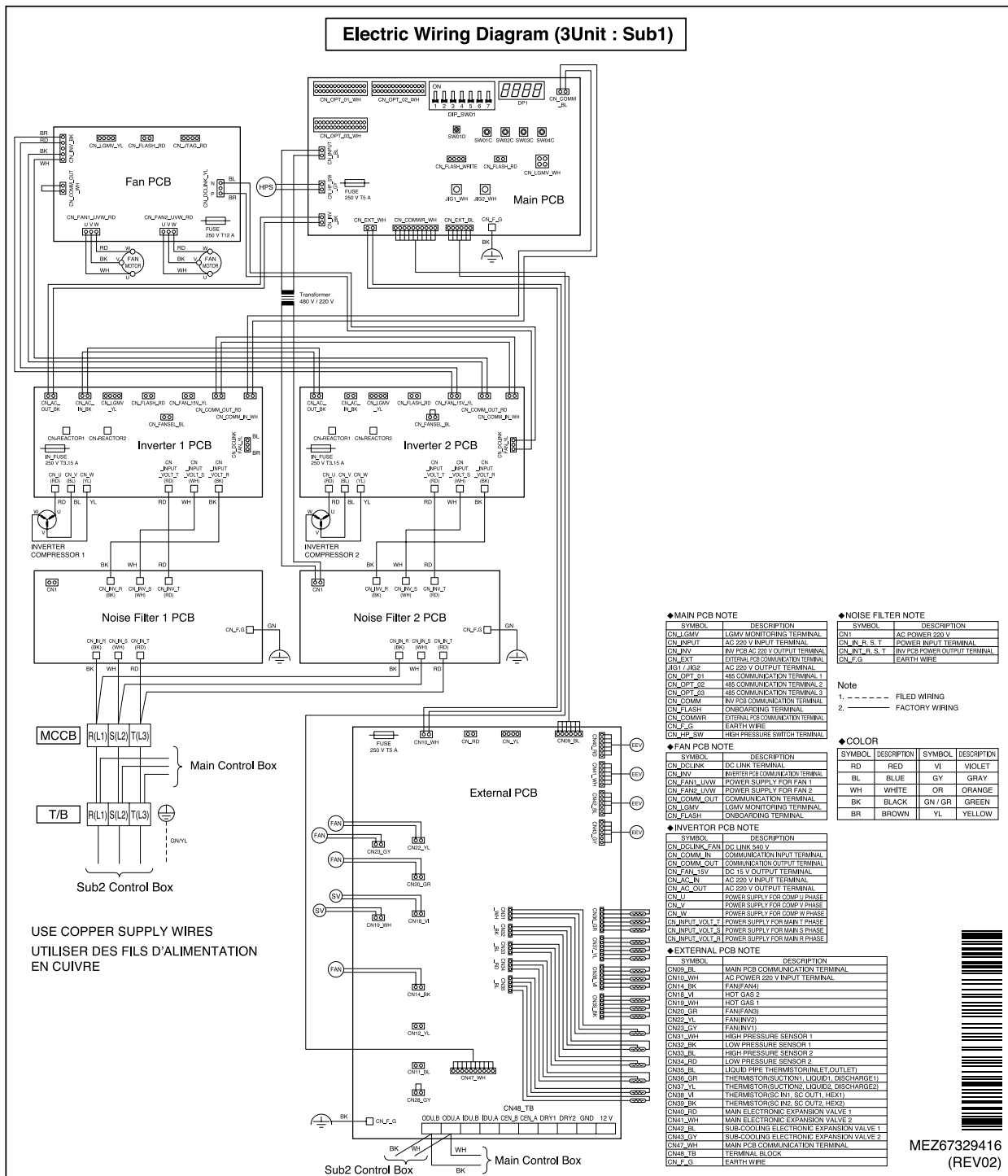

10. Installation of Chiller

Selecting installation location

■ Precaution when selecting the installation location

Select the location that fits the following conditions to install the product.

- Location without direct heat from other heat source
- Location where noise of the chiller does not have negative impact to the neighbors
- Check the installation direction of the unit for the seasonal wind during the winter.
Install the product so that the seasonal wind does not affect only one side of the product.
- Location not exposed to strong winds
- Location that can support the weight of the chiller
- Location with space for air flow and service
- Install the boundary sign, danger sign or barricade, if necessary.
- It is recommended to install a fence around chiller so that people or animals will not be able to access the area.
- When installing the product in areas with high humidity during the winter (Coast, seaside, lakeside), install the product where it is well ventilated and has plenty of exposure to sunlight. (Ex: Roof top with sunlight)
- If the product does not run during the winter, establish a plan to use the anti-freeze for the water supply.
- To prevent the condensed water from flowing, insulate the connected evaporator and pipe.
- To smoothly drain the condensed water, establish an inclined structure.
- Avoid installing the product at locations with the following conditions.
 - Location with corrosive gas such as acid or alkali gas.
(Coolant can leak from the corroded pipes.)
 - Location with electromagnetic wave.
(It can cause the product to malfunction from defective parts.)
 - Location where flammable gas is generated or flows to prevent fire.
 - Location with high level of carbon fiber or dust
 - Special location exposed to oil, steam or emulsified gas

10. Installation of Chiller

■ Precaution for seasonal wind and winter season

In areas with heavy snow or in extremely cold areas, sufficient planning is required for the product to run smoothly.

Even in other areas, planning is required for seasonal wind during the winter season.

- Snow can go into the air discharge outlet of the condenser to freeze inside the chiller. Therefore install a large cover over the chiller for areas with heavy snowfall to prevent the snow from accumulating on the top.
- The chiller can freeze inside when the air inlet is clogged with snow. Therefore install the chiller on the base with at least twice the height of the average snow accumulation.
(Default height of base: 300mm)
- If there is more than 100mm of snow on top of the chiller, always operate the unit after cleaning the snow.
- Do not install the product where there could be negative impact from snow in areas with heavy snowfall. Decide the installation direction of the chiller so that the side of the air heat exchanger does not face the direction of the snow.
(Make the side of the air heat exchanger parallel to the direction of the snowfall.) Install a blocker with the height of the snow accumulation to avoid the snow around the chiller from being sucked into the coil side.
(Prepare on site)
- If the wind comes in one direction of the unit where the seasonal wind is strong, there is a high chance that it can lead to issue with product capacity or imbalance of load. Therefore install the product so that it has consistent effect on the product cycle. If that is not possible, consider using a wind blocker or other devices. In areas with strong seasonal wind during the winter, apply the wind blocker hood, especially near the coastal area, without blocking the suction inlet of the chiller considering the direction of the wind. If the chiller is directly exposed to the seasonal wind during the winter, separately install a wind baffle. (Prepare on site)

10. Installation of Chiller

Installation Guide at the seaside

CAUTION

- When installing the chiller near the coast, make sure that it is not directly exposed to the coastal wind.
- When installing the chiller directly exposed to the coastal wind, separate anti-corrosive treatment must be done on the condenser of the chiller.

* Selecting location of chiller

Install the chiller where the building can block the coastal wind.

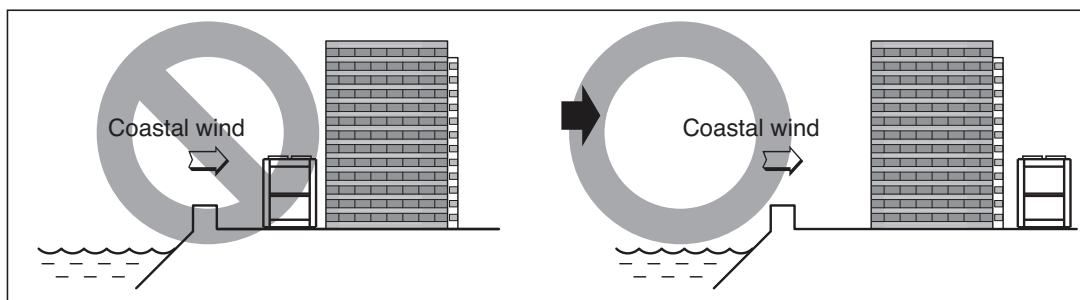

If the product has to be installed inevitably facing the coast, install a wall around the outdoor unit.

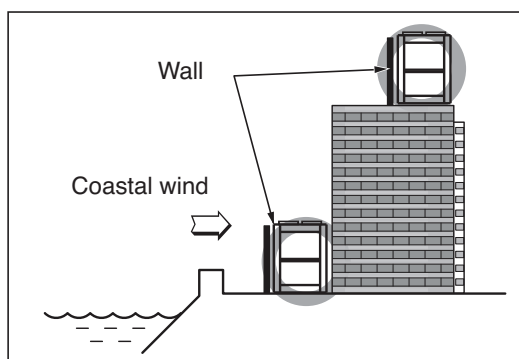

The wall must be made of sufficiently strong material such as concrete to block the coastal wind and must be 1.5 times larger than the size of the product to protect the product 1000mm apart. There must be 1000mm of clearance between the wall and the chiller for smooth circulation of air.

Install the product where the drainage is smooth.

Air-Cooled Scroll Chiller (R410A)

10. Installation of Chiller

When installing the product, secure minimum space as shown below considering the service, suction and discharge of air flow.

■ Consider the ventilation condition.

The air cooled chiller must be installed on open space or must have appropriate ventilation.

When installed along the wall, there must be sufficient space for ventilation.

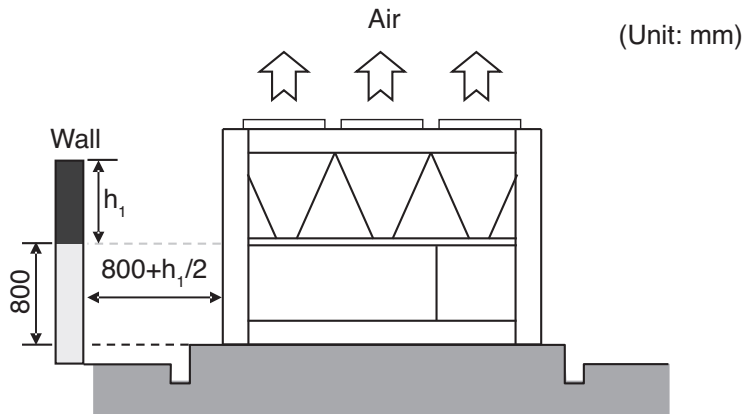

Reference

If the side of the chiller is near the wall and the height of the wall is less than 800mm, the distance between the wall and the chiller must be at least 800mm. If the side of the chiller is near the wall and the wall is 800mm or higher, space of half of h_1 must additionally be secured on top of the 800mm for the distance between the wall and the chiller.

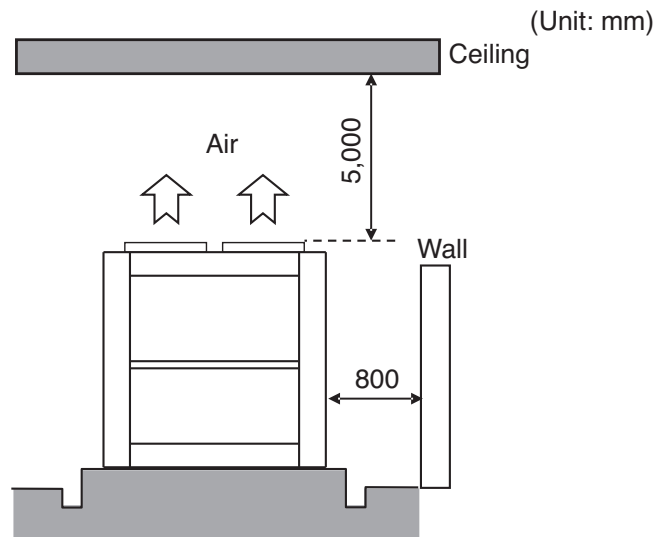

Reference

If there is a ceiling on the top part of the chiller, the distance from the chiller to the ceiling must be 5000mm or above.

If the front or rear side of the chiller is close to the wall, the distance from the wall to the chiller must be 800mm or above.

10. Installation of Chiller

Consider the service space.

- There must be sufficient space for maintenance and repair work around the chiller.

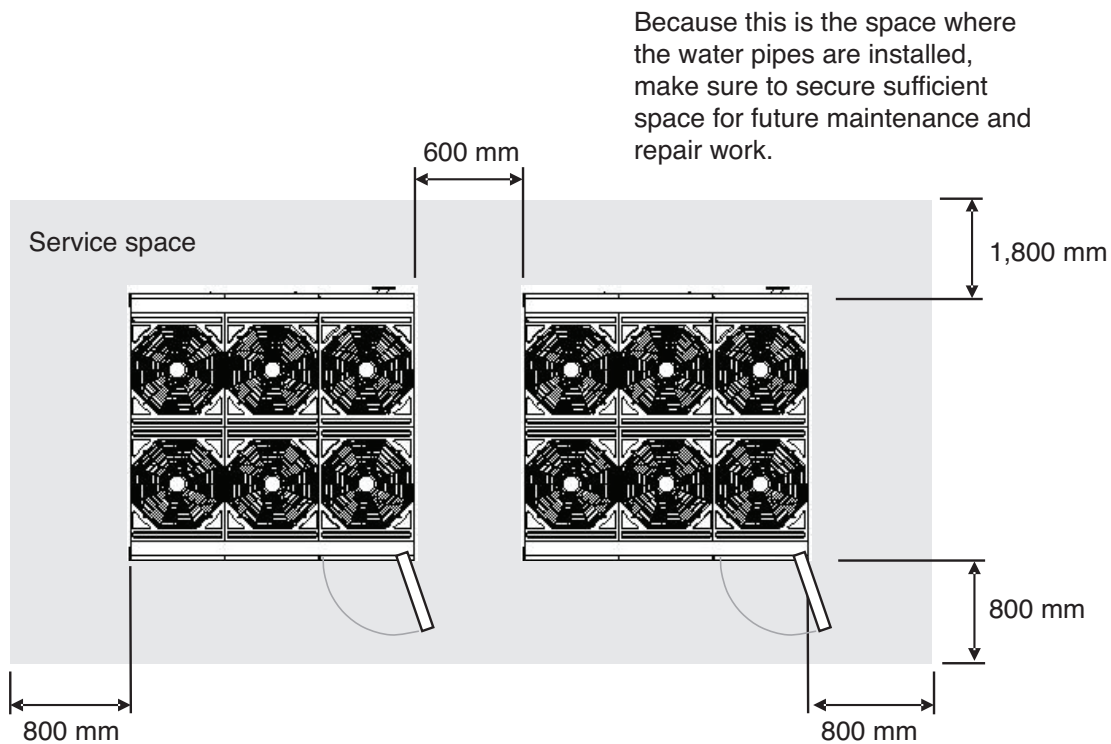
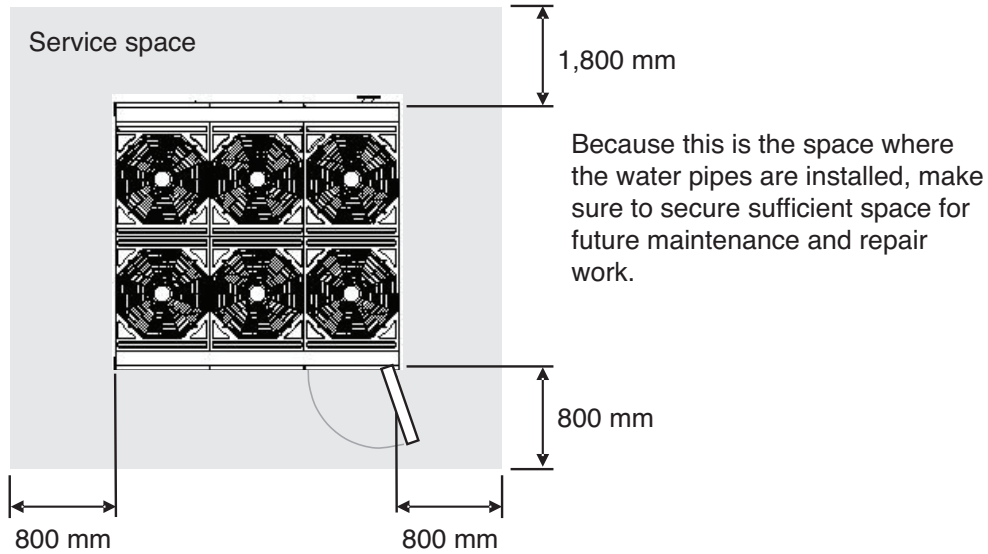

10. Installation of Chiller

Water management

The water quality of the cold (hot) water is described as follows. The water quality must not fall below the following standard. If so, it can be judged to have risk within relatively short period of time.

Item		Water	
		Circulation type cold water	Cold water
Reference	PH(25°C)	6.5 - 8.0	6.5 - 8.0
	Conduction rate (25°C $\mu\text{s/cm}$)	500 or below	200 or below
	Alkali level (PPM)	100 or below	50 or below
	Hardness (PPM)	100 or below	50 or below
	Chlorine ion (PPM)	100 or below	50 or below
	Lactic acid ion (PPM)	100 or below	50 or below
	Iron (PPM)	0.1 or below	0.3 or below
	Sulfur ion (PPM)	Not detected	Not detected
	Ammonium ion (PPM)	0.5 or below	0.2 or below
	Silica (PPM)	50 or below	30 or below

Water pipe connection

- Connect the pipe so that the entrance of the water pipe is correct.
- Permitted water pressure resistance of cold water pipe system is 1MPa
- To prevent any external heat loss or dew drops forming during the cooling operation on the water pipe system, apply thermal insulation treatment.
- Install the air vent at the output end of the water pipe. (Air vent)
- If the thermometer is installed on the inlet/outlet of the water pipe, the operating condition of the chiller can be checked.
- Always install the strainer (20 Mesh or above) that can be cleaned on the water pipe inlet side to filter any alien particles from entering the heat exchanger.
- Always install the strainer on the leveled pipe. (If sand, trash or rust gets mixed to the cold water system, it can cause product failure due to corrosion of metallic parts.)
- Install the on/off valve on the cold water inlet/outlet and bypass pipe on the pipe direction of the device side.
 - For the pipe system, it is recommended to install the bypass and clean the pipe before installing the product and during the annual pipe cleaning.
 - On/Off valve blocks the old water to the chiller that is not operating to reduce the power of the pump. Therefore select whether to install to fit the need of the site.
- Install the pressure gauge and thermometer on the inlet and outlet of the water pipe.
- Always install the flexible joint to reduce the vibration of the pipe and product.
 - Vibration of water pipe system is absorbed to prevent water leakage.
- For the cold water system part, make sure to use the component that complies with designed water pressure or above.
- Before supplying cold water to the chiller, clean inside the pipe system to remove any negative impact of particles to the product.

10. Installation of Chiller



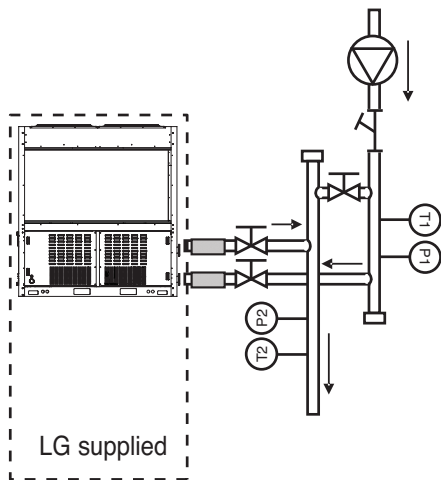

Installation mode A (Recommended method)

* Independent product installation

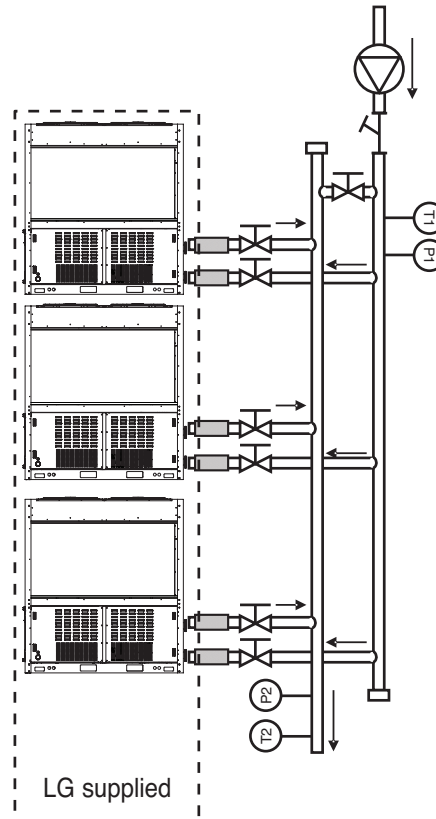

* Independent product installation



Symbol	Description	Symbol	Description
	Valve	T1	Temperature sensor (1: Inlet 2: Outlet)
	Strainer	P1	Pressure gauge (1: Inlet, 2 Outlet)
	Flexible joint		Cold water pump

10. Installation of Chiller



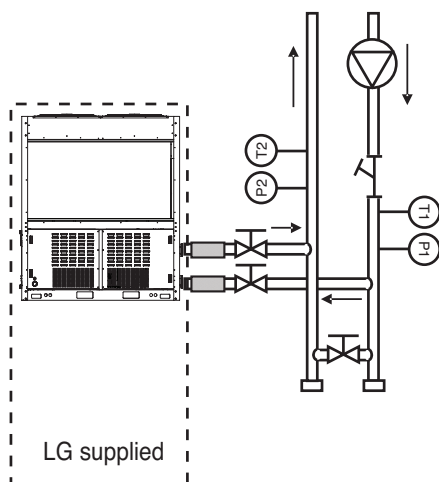

Installation mode B

* Independent product installation

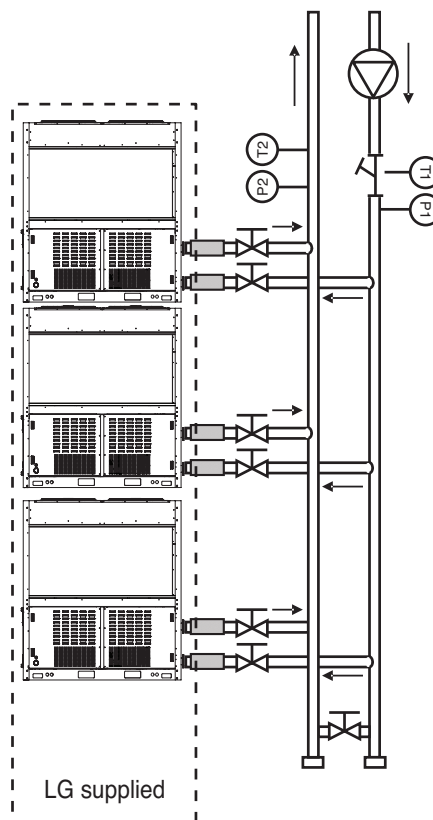

* Independent product installation



Symbol	Description	Symbol	Description
	Valve	T1	Temperature sensor (1: Inlet 2: Outlet)
	Strainer	P1	Pressure gauge (1: Inlet, 2 Outlet)
	Flexible joint		Cold water pump

Air-Cooled Scroll Chiller (R410A)

10. Installation of Chiller

CAUTION

- If the winter outdoor temperature is 0°C or below, take following measures to prevent the pipe from freezing as shown below.
 - If the outdoor temperature is low, the circulation water can freeze to damage the heat exchanger of the product when the product is stopped.
If there is possibility of damage from low outdoor temperature, operate the pump to prevent the water from freezing.
 - If the product does not operate for a long period of time during the winter season, remove all the circulation water to prevent the damage of heat exchanger and pipe from freezing.
 - Add anti-freeze additive to prevent the circulation water from freezing during the winter season.
- Maintain the cold water flux within the designed flux to ensure appropriate chiller performance and reduce the tube damage from rusting, scaling and corrosion. LG is not responsible for any damage of chiller from poor water quality management or inappropriate processing water.

Water pipe installation

- Appropriate pressure of pipe connection is flange connection of 1 MPa or below.
- Size of the water pipe must be the same as that of the product or larger.
- If there is risk of dew drops forming, always install the thermal insulation material on the outlet pipe of the cold water.
- To avoid connected water pipe from creeping from the load, use appropriate hook for support.
- To prevent the pipe connected part from freezing during the winter season, always install the drain valve at the most bottom of the pipe system.
- Cold water inlet pipe is located at the bottom and the outlet pipe is installed on the top.
- When connecting several chillers, refer to the following for common pipe size.

Full product capacity	20 RT	40 RT	60 RT	80 RT	100 RT	120 RT	140 RT	160 RT	180 RT
Common pipe size	65 A	80 A	100 A	100 A	125 A	125 A	125 A	150 A	150 A
Product	20 RT	●							
	40 RT		●		●●	●	●●	●	
	60 RT			●		●	●●	●	●●●

Full product capacity	200 RT	220 RT	240 RT	260 RT	280 RT	300 RT
Common pipe size	150 A	200 A	200 A	200 A	200 A	200 A
Product	20 RT					
	40 RT	●●	●		●●	●
	60 RT	●●	●●●	●●●●	●●●	●●●●●

Water pump control

- If the cold water pump is not operating for a long period of time or if the anti-freeze liquid is not used as the cold water, the anti-freeze pump control must be installed to prevent the pipe from freezing.
- The vibration of the pump can transfer to the pipe to cause noise indoors. As the plan to prevent the noise from spreading in the pump, install flexible joints at the inlet/outlet and use the anti-vibration amount for the pump support.

10. Installation of Chiller

Unit Combination

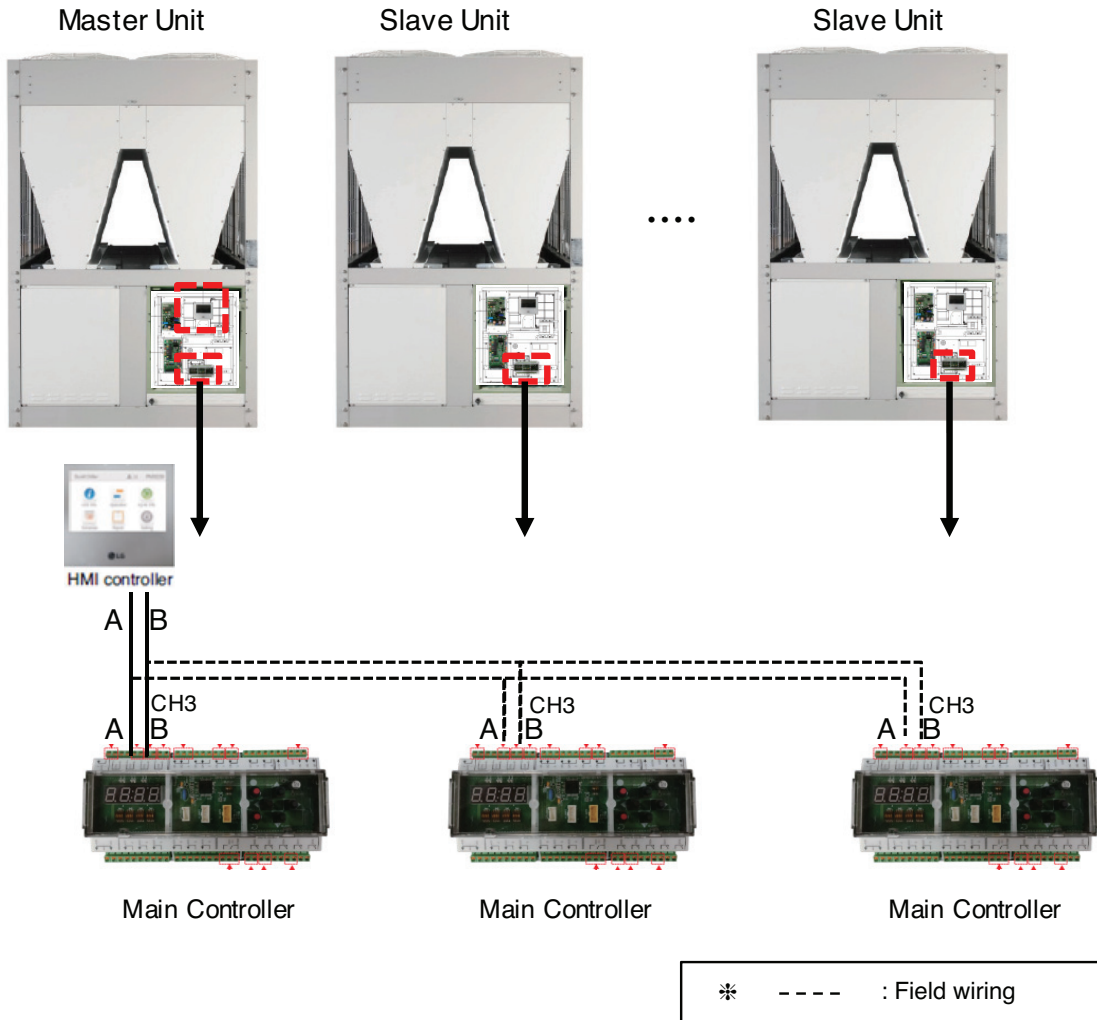

- 1) Communication line is divided A into B like a picture and is jump connected to Main Unit and Main Controller CH3 of Slave unit.
- 2) Communication line jump connected is divided A into B to HMI of Master Unit and in connected.
- 3) Use 2-line shield as a communication line
- 4) Separately install the communication and power cable of the chiller so that communication cable is not affected by the electric noise generated from power cable(Do not pass though the same electric pipe)
- 5) Unit combination is able to connect up to 5 units.

! WARNING

If number and address of product to want to interlock is not set from HMI, Error will occur.(please refer to control>freezer interlocking control about HMI address setting)

If Main Controller address doesn't match HMI address, Error will occur. .(please refer to control>freezer address setting about Controller address setting)

Air-Cooled Scroll Chiller (R410A)

10. Installation of Chiller

■ 208 - 230V

Set Model	Unit Combination				
A(C)CAH020VETB	A(C)CAH020VETB	-	-	-	-
A(C)CAH033VETB	A(C)CAH033VETB	-	-	-	-
A(C)CAH040VETB	A(C)CAH040VETB	-	-	-	-
A(C)CAH050VETB	A(C)CAH050VETB	-	-	-	-
A(C)CAH060VATB	A(C)CAH020VETB	A(C)CAH040VETB	-	-	-
A(C)CAH060VETB	A(C)CAH060VETB	-	-	-	-
A(C)CAH066VATB	A(C)CAH033VETB	A(C)CAH033VETB	-	-	-
A(C)CAH073VATB	A(C)CAH033VETB	A(C)CAH040VETB	-	-	-
A(C)CAH080VATB	A(C)CAH040VETB	A(C)CAH040VETB	-	-	-
A(C)CAH083VATB	A(C)CAH033VETB	A(C)CAH050VETB	-	-	-
A(C)CAH093VATB	A(C)CAH033VETB	A(C)CAH060VETB	-	-	-
A(C)CAH100VATB	A(C)CAH040VETB	A(C)CAH060VETB	-	-	-
A(C)CAH100VATB	A(C)CAH050VETB	A(C)CAH050VETB	-	-	-
A(C)CAH100VATB	A(C)CAH020VETB	A(C)CAH040VETB	A(C)CAH040VETB	-	-
A(C)CAH110VATB	A(C)CAH050VETB	A(C)CAH060VETB	-	-	-
A(C)CAH116VATB	A(C)CAH033VETB	A(C)CAH033VETB	A(C)CAH050VETB	-	-
A(C)CAH120VATB	A(C)CAH060VETB	A(C)CAH060VETB	-	-	-
A(C)CAH126VATB	A(C)CAH033VETB	A(C)CAH033VETB	A(C)CAH060VETB	-	-
A(C)CAH133VATB	A(C)CAH033VETB	A(C)CAH040VETB	A(C)CAH060VETB	-	-
A(C)CAH140VATB	A(C)CAH040VETB	A(C)CAH040VETB	A(C)CAH060VETB	-	-
A(C)CAH140VATB	A(C)CAH020VETB	A(C)CAH040VETB	A(C)CAH040VETB	A(C)CAH040VETB	-
A(C)CAH143VATB	A(C)CAH033VETB	A(C)CAH050VETB	A(C)CAH060VETB	-	-
A(C)CAH153VATB	A(C)CAH033VETB	A(C)CAH060VETB	A(C)CAH060VETB	-	-
A(C)CAH160VATB	A(C)CAH040VETB	A(C)CAH060VETB	A(C)CAH060VETB	-	-
A(C)CAH160VATB	A(C)CAH050VETB	A(C)CAH050VETB	A(C)CAH060VETB	-	-
A(C)CAH170VATB	A(C)CAH050VETB	A(C)CAH060VETB	A(C)CAH060VETB	-	-
A(C)CAH176VATB	A(C)CAH033VETB	A(C)CAH033VETB	A(C)CAH050VETB	A(C)CAH060VETB	-
A(C)CAH180VATB	A(C)CAH060VETB	A(C)CAH060VETB	A(C)CAH060VETB	-	-
A(C)CAH180VATB	A(C)CAH020VETB	A(C)CAH040VETB	A(C)CAH040VETB	A(C)CAH040VETB	A(C)CAH040VETB
A(C)CAH186VATB	A(C)CAH033VETB	A(C)CAH033VETB	A(C)CAH060VETB	A(C)CAH060VETB	-
A(C)CAH193VATB	A(C)CAH033VETB	A(C)CAH040VETB	A(C)CAH060VETB	A(C)CAH060VETB	-
A(C)CAH200VATB	A(C)CAH040VETB	A(C)CAH040VETB	A(C)CAH060VETB	A(C)CAH060VETB	-
A(C)CAH203VATB	A(C)CAH033VETB	A(C)CAH050VETB	A(C)CAH060VETB	A(C)CAH060VETB	-
A(C)CAH213VATB	A(C)CAH033VETB	A(C)CAH060VETB	A(C)CAH060VETB	A(C)CAH060VETB	-
A(C)CAH220VATB	A(C)CAH040VETB	A(C)CAH060VETB	A(C)CAH060VETB	A(C)CAH060VETB	-
A(C)CAH220VATB	A(C)CAH050VETB	A(C)CAH050VETB	A(C)CAH060VETB	A(C)CAH060VETB	-
A(C)CAH230VATB	A(C)CAH050VETB	A(C)CAH060VETB	A(C)CAH060VETB	A(C)CAH060VETB	-
A(C)CAH236VATB	A(C)CAH033VETB	A(C)CAH033VETB	A(C)CAH050VETB	A(C)CAH060VETB	A(C)CAH060VETB
A(C)CAH240VATB	A(C)CAH060VETB	A(C)CAH060VETB	A(C)CAH060VETB	A(C)CAH060VETB	-
A(C)CAH246VATB	A(C)CAH033VETB	A(C)CAH033VETB	A(C)CAH060VETB	A(C)CAH060VETB	A(C)CAH060VETB

Air-Cooled Scroll Chiller (R410A)

10. Installation of Chiller

Set Model	Unit Combination				
A(C)CAH253VATB	A(C)CAH033VETB	A(C)CAH040VETB	A(C)CAH060VETB	A(C)CAH060VETB	A(C)CAH060VETB
A(C)CAH260VATB	A(C)CAH040VETB	A(C)CAH040VETB	A(C)CAH060VETB	A(C)CAH060VETB	A(C)CAH060VETB
A(C)CAH263VATB	A(C)CAH033VETB	A(C)CAH050VETB	A(C)CAH060VETB	A(C)CAH060VETB	A(C)CAH060VETB
A(C)CAH273VATB	A(C)CAH033VETB	A(C)CAH060VETB	A(C)CAH060VETB	A(C)CAH060VETB	A(C)CAH060VETB
A(C)CAH280VATB	A(C)CAH040VETB	A(C)CAH060VETB	A(C)CAH060VETB	A(C)CAH060VETB	A(C)CAH060VETB
A(C)CAH280VATB	A(C)CAH050VETB	A(C)CAH050VETB	A(C)CAH060VETB	A(C)CAH060VETB	A(C)CAH060VETB
A(C)CAH290VATB	A(C)CAH050VETB	A(C)CAH060VETB	A(C)CAH060VETB	A(C)CAH060VETB	A(C)CAH060VETB
A(C)CAH300VATB	A(C)CAH060VETB	A(C)CAH060VETB	A(C)CAH060VETB	A(C)CAH060VETB	A(C)CAH060VETB

Air-Cooled Scroll Chiller (R410A)

10. Installation of Chiller

■ 380 - 415V

Set Model	Unit Combination				
A(C)CAH020LETB	A(C)CAH020LETB	-	-	-	-
A(C)CAH023LETB	A(C)CAH023LETB	-	-	-	-
A(C)CAH033LETB	A(C)CAH033LETB	-	-	-	-
A(C)CAH040LETB	A(C)CAH040LETB	-	-	-	-
A(C)CAH043LATB	A(C)CAH020LETB	A(C)CAH023LETB	-	-	-
A(C)CAH045LETB	A(C)CAH045LETB	-	-	-	-
A(C)CAH050LETB	A(C)CAH050LETB	-	-	-	-
A(C)CAH060LETB	A(C)CAH060LETB	-	-	-	-
A(C)CAH067LETB	A(C)CAH067LETB	-	-	-	-
A(C)CAH073LATB	A(C)CAH033LETB	A(C)CAH040LETB	-	-	-
A(C)CAH080LATB	A(C)CAH040LETB	A(C)CAH040LETB	-	-	-
A(C)CAH085LATB	A(C)CAH040LETB	A(C)CAH045LETB	-	-	-
A(C)CAH090LATB	A(C)CAH045LETB	A(C)CAH045LETB	-	-	-
A(C)CAH093LATB	A(C)CAH033LETB	A(C)CAH060LETB	-	-	-
A(C)CAH100LATB	A(C)CAH040LETB	A(C)CAH060LETB	-	-	-
A(C)CAH105LATB	A(C)CAH045LETB	A(C)CAH060LETB	-	-	-
A(C)CAH107LATB	A(C)CAH040LETB	A(C)CAH067LETB	-	-	-
A(C)CAH112LATB	A(C)CAH045LETB	A(C)CAH067LETB	-	-	-
A(C)CAH117LATB	A(C)CAH050LETB	A(C)CAH067LETB	-	-	-
A(C)CAH120LATB	A(C)CAH060LETB	A(C)CAH060LETB	-	-	-
A(C)CAH127LATB	A(C)CAH060LETB	A(C)CAH067LETB	-	-	-
A(C)CAH134LATB	A(C)CAH067LETB	A(C)CAH067LETB	-	-	-
A(C)CAH135LATB	A(C)CAH045LETB	A(C)CAH045LETB	A(C)CAH045LETB	-	-
A(C)CAH140LATB	A(C)CAH040LETB	A(C)CAH040LETB	A(C)CAH060LETB	-	-
A(C)CAH140LATB	A(C)CAH033LETB	A(C)CAH040LETB	A(C)CAH067LETB	-	-
A(C)CAH140LATB	A(C)CAH045LETB	A(C)CAH045LETB	A(C)CAH050LETB	-	-
A(C)CAH147LATB	A(C)CAH040LETB	A(C)CAH040LETB	A(C)CAH067LETB	-	-
A(C)CAH150LATB	A(C)CAH045LETB	A(C)CAH045LETB	A(C)CAH060LETB	-	-
A(C)CAH152LATB	A(C)CAH040LETB	A(C)CAH045LETB	A(C)CAH067LETB	-	-
A(C)CAH157LATB	A(C)CAH045LETB	A(C)CAH045LETB	A(C)CAH067LETB	-	-
A(C)CAH157LATB	A(C)CAH023LETB	A(C)CAH067LETB	A(C)CAH067LETB	-	-
A(C)CAH160LATB	A(C)CAH040LETB	A(C)CAH060LETB	A(C)CAH060LETB	-	-
A(C)CAH165LATB	A(C)CAH045LETB	A(C)CAH060LETB	A(C)CAH060LETB	-	-
A(C)CAH167LATB	A(C)CAH040LETB	A(C)CAH060LETB	A(C)CAH067LETB	-	-
A(C)CAH170LATB	A(C)CAH050LETB	A(C)CAH060LETB	A(C)CAH060LETB	-	-
A(C)CAH172LATB	A(C)CAH045LETB	A(C)CAH060LETB	A(C)CAH067LETB	-	-
A(C)CAH174LATB	A(C)CAH040LETB	A(C)CAH067LETB	A(C)CAH067LETB	-	-
A(C)CAH175LATB	A(C)CAH040LETB	A(C)CAH045LETB	A(C)CAH045LETB	A(C)CAH045LETB	-
A(C)CAH179LATB	A(C)CAH045LETB	A(C)CAH067LETB	A(C)CAH067LETB	-	-
A(C)CAH180LATB	A(C)CAH060LETB	A(C)CAH060LETB	A(C)CAH060LETB	-	-

Air-Cooled Scroll Chiller (R410A)

10. Installation of Chiller

Set Model	Unit Combination				
A(C)CAH180LATB	A(C)CAH045LETB	A(C)CAH045LETB	A(C)CAH045LETB	A(C)CAH045LETB	-
A(C)CAH184LATB	A(C)CAH050LETB	A(C)CAH067LETB	A(C)CAH067LETB	-	-
A(C)CAH185LATB	A(C)CAH045LETB	A(C)CAH045LETB	A(C)CAH045LETB	A(C)CAH050LETB	-
A(C)CAH187LATB	A(C)CAH060LETB	A(C)CAH060LETB	A(C)CAH067LETB	-	-
A(C)CAH187LATB	A(C)CAH040LETB	A(C)CAH040LETB	A(C)CAH040LETB	A(C)CAH067LETB	-
A(C)CAH192LATB	A(C)CAH040LETB	A(C)CAH040LETB	A(C)CAH045LETB	A(C)CAH067LETB	-
A(C)CAH194LATB	A(C)CAH060LETB	A(C)CAH067LETB	A(C)CAH067LETB	-	-
A(C)CAH197LATB	A(C)CAH040LETB	A(C)CAH045LETB	A(C)CAH045LETB	A(C)CAH067LETB	-
A(C)CAH200LATB	A(C)CAH040LETB	A(C)CAH040LETB	A(C)CAH060LETB	A(C)CAH060LETB	-
A(C)CAH200LATB	A(C)CAH033LETB	A(C)CAH040LETB	A(C)CAH060LETB	A(C)CAH067LETB	-
A(C)CAH200LATB	A(C)CAH020LETB	A(C)CAH045LETB	A(C)CAH045LETB	A(C)CAH045LETB	A(C)CAH045LETB
A(C)CAH201LATB	A(C)CAH067LETB	A(C)CAH067LETB	A(C)CAH067LETB	-	-
A(C)CAH202LATB	A(C)CAH045LETB	A(C)CAH045LETB	A(C)CAH045LETB	A(C)CAH067LETB	-
A(C)CAH202LATB	A(C)CAH023LETB	A(C)CAH045LETB	A(C)CAH067LETB	A(C)CAH067LETB	-
A(C)CAH207LATB	A(C)CAH040LETB	A(C)CAH040LETB	A(C)CAH060LETB	A(C)CAH067LETB	-
A(C)CAH210LATB	A(C)CAH045LETB	A(C)CAH045LETB	A(C)CAH060LETB	A(C)CAH060LETB	-
A(C)CAH210LATB	A(C)CAH040LETB	A(C)CAH040LETB	A(C)CAH040LETB	A(C)CAH045LETB	A(C)CAH045LETB
A(C)CAH212LATB	A(C)CAH040LETB	A(C)CAH045LETB	A(C)CAH060LETB	A(C)CAH067LETB	-
A(C)CAH214LATB	A(C)CAH040LETB	A(C)CAH040LETB	A(C)CAH067LETB	A(C)CAH067LETB	-
A(C)CAH217LATB	A(C)CAH045LETB	A(C)CAH045LETB	A(C)CAH060LETB	A(C)CAH067LETB	-
A(C)CAH217LATB	A(C)CAH023LETB	A(C)CAH060LETB	A(C)CAH067LETB	A(C)CAH067LETB	-
A(C)CAH217LATB	A(C)CAH020LETB	A(C)CAH023LETB	A(C)CAH040LETB	A(C)CAH067LETB	A(C)CAH067LETB
A(C)CAH219LATB	A(C)CAH040LETB	A(C)CAH045LETB	A(C)CAH067LETB	A(C)CAH067LETB	-
A(C)CAH220LATB	A(C)CAH040LETB	A(C)CAH045LETB	A(C)CAH045LETB	A(C)CAH045LETB	A(C)CAH045LETB
A(C)CAH222LATB	A(C)CAH045LETB	A(C)CAH050LETB	A(C)CAH060LETB	A(C)CAH067LETB	-
A(C)CAH224LATB	A(C)CAH045LETB	A(C)CAH045LETB	A(C)CAH067LETB	A(C)CAH067LETB	-
A(C)CAH224LATB	A(C)CAH023LETB	A(C)CAH067LETB	A(C)CAH067LETB	A(C)CAH067LETB	-
A(C)CAH225LATB	A(C)CAH045LETB	A(C)CAH060LETB	A(C)CAH060LETB	A(C)CAH060LETB	-
A(C)CAH225LATB	A(C)CAH045LETB	A(C)CAH045LETB	A(C)CAH045LETB	A(C)CAH045LETB	A(C)CAH045LETB
A(C)CAH227LATB	A(C)CAH033LETB	A(C)CAH060LETB	A(C)CAH067LETB	A(C)CAH067LETB	-
A(C)CAH229LATB	A(C)CAH045LETB	A(C)CAH050LETB	A(C)CAH067LETB	A(C)CAH067LETB	-
A(C)CAH232LATB	A(C)CAH040LETB	A(C)CAH040LETB	A(C)CAH040LETB	A(C)CAH045LETB	A(C)CAH067LETB
A(C)CAH233LATB	A(C)CAH033LETB	A(C)CAH033LETB	A(C)CAH040LETB	A(C)CAH060LETB	A(C)CAH067LETB
A(C)CAH234LATB	A(C)CAH040LETB	A(C)CAH060LETB	A(C)CAH067LETB	A(C)CAH067LETB	-
A(C)CAH237LATB	A(C)CAH040LETB	A(C)CAH040LETB	A(C)CAH045LETB	A(C)CAH045LETB	A(C)CAH067LETB
A(C)CAH239LATB	A(C)CAH045LETB	A(C)CAH060LETB	A(C)CAH067LETB	A(C)CAH067LETB	-
A(C)CAH240LATB	A(C)CAH023LETB	A(C)CAH045LETB	A(C)CAH045LETB	A(C)CAH060LETB	A(C)CAH067LETB
A(C)CAH240LATB	A(C)CAH033LETB	A(C)CAH033LETB	A(C)CAH040LETB	A(C)CAH067LETB	A(C)CAH067LETB
A(C)CAH241LATB	A(C)CAH040LETB	A(C)CAH067LETB	A(C)CAH067LETB	A(C)CAH067LETB	-
A(C)CAH242LATB	A(C)CAH040LETB	A(C)CAH045LETB	A(C)CAH045LETB	A(C)CAH045LETB	A(C)CAH067LETB

Air-Cooled Scroll Chiller (R410A)

10. Installation of Chiller

Set Model	Unit Combination				
A(C)CAH244LATB	A(C)CAH050LETB	A(C)CAH060LETB	A(C)CAH067LETB	A(C)CAH067LETB	-
A(C)CAH246LATB	A(C)CAH045LETB	A(C)CAH067LETB	A(C)CAH067LETB	A(C)CAH067LETB	-
A(C)CAH247LATB	A(C)CAH060LETB	A(C)CAH060LETB	A(C)CAH060LETB	A(C)CAH067LETB	-
A(C)CAH247LATB	A(C)CAH045LETB	A(C)CAH045LETB	A(C)CAH045LETB	A(C)CAH045LETB	A(C)CAH067LETB
A(C)CAH247LATB	A(C)CAH023LETB	A(C)CAH045LETB	A(C)CAH045LETB	A(C)CAH067LETB	A(C)CAH067LETB
A(C)CAH247LATB	A(C)CAH040LETB	A(C)CAH040LETB	A(C)CAH040LETB	A(C)CAH060LETB	A(C)CAH067LETB
A(C)CAH250LATB	A(C)CAH033LETB	A(C)CAH045LETB	A(C)CAH045LETB	A(C)CAH060LETB	A(C)CAH067LETB
A(C)CAH251LATB	A(C)CAH050LETB	A(C)CAH067LETB	A(C)CAH067LETB	A(C)CAH067LETB	-
A(C)CAH252LATB	A(C)CAH040LETB	A(C)CAH040LETB	A(C)CAH045LETB	A(C)CAH060LETB	A(C)CAH067LETB
A(C)CAH252LATB	A(C)CAH045LETB	A(C)CAH045LETB	A(C)CAH045LETB	A(C)CAH050LETB	A(C)CAH067LETB
A(C)CAH254LATB	A(C)CAH060LETB	A(C)CAH060LETB	A(C)CAH067LETB	A(C)CAH067LETB	-
A(C)CAH254LATB	A(C)CAH040LETB	A(C)CAH040LETB	A(C)CAH040LETB	A(C)CAH067LETB	A(C)CAH067LETB
A(C)CAH257LATB	A(C)CAH040LETB	A(C)CAH045LETB	A(C)CAH045LETB	A(C)CAH060LETB	A(C)CAH067LETB
A(C)CAH257LATB	A(C)CAH033LETB	A(C)CAH045LETB	A(C)CAH045LETB	A(C)CAH067LETB	A(C)CAH067LETB
A(C)CAH257LATB	A(C)CAH023LETB	A(C)CAH040LETB	A(C)CAH060LETB	A(C)CAH067LETB	A(C)CAH067LETB
A(C)CAH257LATB	A(C)CAH023LETB	A(C)CAH033LETB	A(C)CAH067LETB	A(C)CAH067LETB	A(C)CAH067LETB
A(C)CAH257LATB	A(C)CAH045LETB	A(C)CAH045LETB	A(C)CAH050LETB	A(C)CAH050LETB	A(C)CAH067LETB
A(C)CAH259LATB	A(C)CAH040LETB	A(C)CAH040LETB	A(C)CAH045LETB	A(C)CAH067LETB	A(C)CAH067LETB
A(C)CAH260LATB	A(C)CAH033LETB	A(C)CAH040LETB	A(C)CAH060LETB	A(C)CAH060LETB	A(C)CAH067LETB
A(C)CAH260LATB	A(C)CAH023LETB	A(C)CAH050LETB	A(C)CAH060LETB	A(C)CAH060LETB	A(C)CAH067LETB
A(C)CAH261LATB	A(C)CAH060LETB	A(C)CAH067LETB	A(C)CAH067LETB	A(C)CAH067LETB	-
A(C)CAH262LATB	A(C)CAH023LETB	A(C)CAH045LETB	A(C)CAH060LETB	A(C)CAH067LETB	A(C)CAH067LETB
A(C)CAH264LATB	A(C)CAH040LETB	A(C)CAH045LETB	A(C)CAH045LETB	A(C)CAH067LETB	A(C)CAH067LETB
A(C)CAH264LATB	A(C)CAH023LETB	A(C)CAH040LETB	A(C)CAH067LETB	A(C)CAH067LETB	A(C)CAH067LETB
A(C)CAH267LATB	A(C)CAH040LETB	A(C)CAH040LETB	A(C)CAH060LETB	A(C)CAH060LETB	A(C)CAH067LETB
A(C)CAH267LATB	A(C)CAH033LETB	A(C)CAH040LETB	A(C)CAH060LETB	A(C)CAH067LETB	A(C)CAH067LETB
A(C)CAH267LATB	A(C)CAH045LETB	A(C)CAH045LETB	A(C)CAH050LETB	A(C)CAH060LETB	A(C)CAH067LETB
A(C)CAH267LATB	A(C)CAH033LETB	A(C)CAH033LETB	A(C)CAH067LETB	A(C)CAH067LETB	A(C)CAH067LETB
A(C)CAH267LATB	A(C)CAH050LETB	A(C)CAH050LETB	A(C)CAH050LETB	A(C)CAH050LETB	A(C)CAH067LETB
A(C)CAH268LATB	A(C)CAH067LETB	A(C)CAH067LETB	A(C)CAH067LETB	A(C)CAH067LETB	-
A(C)CAH269LATB	A(C)CAH045LETB	A(C)CAH045LETB	A(C)CAH045LETB	A(C)CAH067LETB	A(C)CAH067LETB
A(C)CAH269LATB	A(C)CAH023LETB	A(C)CAH045LETB	A(C)CAH067LETB	A(C)CAH067LETB	A(C)CAH067LETB
A(C)CAH270LATB	A(C)CAH045LETB	A(C)CAH045LETB	A(C)CAH060LETB	A(C)CAH060LETB	A(C)CAH060LETB
A(C)CAH272LATB	A(C)CAH040LETB	A(C)CAH045LETB	A(C)CAH060LETB	A(C)CAH060LETB	A(C)CAH067LETB
A(C)CAH272LATB	A(C)CAH033LETB	A(C)CAH045LETB	A(C)CAH060LETB	A(C)CAH067LETB	A(C)CAH067LETB
A(C)CAH272LATB	A(C)CAH045LETB	A(C)CAH050LETB	A(C)CAH050LETB	A(C)CAH060LETB	A(C)CAH067LETB
A(C)CAH274LATB	A(C)CAH040LETB	A(C)CAH040LETB	A(C)CAH060LETB	A(C)CAH067LETB	A(C)CAH067LETB
A(C)CAH274LATB	A(C)CAH045LETB	A(C)CAH045LETB	A(C)CAH050LETB	A(C)CAH067LETB	A(C)CAH067LETB
A(C)CAH274LATB	A(C)CAH023LETB	A(C)CAH050LETB	A(C)CAH067LETB	A(C)CAH067LETB	A(C)CAH067LETB
A(C)CAH277LATB	A(C)CAH045LETB	A(C)CAH045LETB	A(C)CAH060LETB	A(C)CAH060LETB	A(C)CAH067LETB

Air-Cooled Scroll Chiller (R410A)

10. Installation of Chiller

Set Model	Unit Combination				
A(C)CAH279LATB	A(C)CAH040LETB	A(C)CAH045LETB	A(C)CAH060LETB	A(C)CAH067LETB	A(C)CAH067LETB
A(C)CAH279LATB	A(C)CAH033LETB	A(C)CAH045LETB	A(C)CAH067LETB	A(C)CAH067LETB	A(C)CAH067LETB
A(C)CAH279LATB	A(C)CAH045LETB	A(C)CAH050LETB	A(C)CAH050LETB	A(C)CAH067LETB	A(C)CAH067LETB
A(C)CAH280LATB	A(C)CAH050LETB	A(C)CAH050LETB	A(C)CAH060LETB	A(C)CAH060LETB	A(C)CAH060LETB
A(C)CAH281LATB	A(C)CAH040LETB	A(C)CAH040LETB	A(C)CAH067LETB	A(C)CAH067LETB	A(C)CAH067LETB
A(C)CAH282LATB	A(C)CAH045LETB	A(C)CAH050LETB	A(C)CAH060LETB	A(C)CAH060LETB	A(C)CAH067LETB
A(C)CAH284LATB	A(C)CAH045LETB	A(C)CAH045LETB	A(C)CAH060LETB	A(C)CAH067LETB	A(C)CAH067LETB
A(C)CAH284LATB	A(C)CAH023LETB	A(C)CAH060LETB	A(C)CAH067LETB	A(C)CAH067LETB	A(C)CAH067LETB
A(C)CAH284LATB	A(C)CAH033LETB	A(C)CAH050LETB	A(C)CAH067LETB	A(C)CAH067LETB	A(C)CAH067LETB
A(C)CAH285LATB	A(C)CAH045LETB	A(C)CAH060LETB	A(C)CAH060LETB	A(C)CAH060LETB	A(C)CAH060LETB
A(C)CAH286LATB	A(C)CAH040LETB	A(C)CAH045LETB	A(C)CAH067LETB	A(C)CAH067LETB	A(C)CAH067LETB
A(C)CAH287LATB	A(C)CAH040LETB	A(C)CAH060LETB	A(C)CAH060LETB	A(C)CAH060LETB	A(C)CAH067LETB
A(C)CAH287LATB	A(C)CAH033LETB	A(C)CAH060LETB	A(C)CAH060LETB	A(C)CAH067LETB	A(C)CAH067LETB
A(C)CAH287LATB	A(C)CAH050LETB	A(C)CAH050LETB	A(C)CAH060LETB	A(C)CAH060LETB	A(C)CAH067LETB
A(C)CAH289LATB	A(C)CAH045LETB	A(C)CAH050LETB	A(C)CAH060LETB	A(C)CAH067LETB	A(C)CAH067LETB
A(C)CAH291LATB	A(C)CAH045LETB	A(C)CAH045LETB	A(C)CAH067LETB	A(C)CAH067LETB	A(C)CAH067LETB
A(C)CAH291LATB	A(C)CAH023LETB	A(C)CAH067LETB	A(C)CAH067LETB	A(C)CAH067LETB	A(C)CAH067LETB
A(C)CAH292LATB	A(C)CAH045LETB	A(C)CAH060LETB	A(C)CAH060LETB	A(C)CAH060LETB	A(C)CAH067LETB
A(C)CAH294LATB	A(C)CAH040LETB	A(C)CAH060LETB	A(C)CAH060LETB	A(C)CAH067LETB	A(C)CAH067LETB
A(C)CAH294LATB	A(C)CAH033LETB	A(C)CAH060LETB	A(C)CAH067LETB	A(C)CAH067LETB	A(C)CAH067LETB
A(C)CAH294LATB	A(C)CAH050LETB	A(C)CAH050LETB	A(C)CAH060LETB	A(C)CAH067LETB	A(C)CAH067LETB
A(C)CAH296LATB	A(C)CAH045LETB	A(C)CAH050LETB	A(C)CAH067LETB	A(C)CAH067LETB	A(C)CAH067LETB
A(C)CAH299LATB	A(C)CAH045LETB	A(C)CAH060LETB	A(C)CAH060LETB	A(C)CAH067LETB	A(C)CAH067LETB
A(C)CAH300LATB	A(C)CAH060LETB	A(C)CAH060LETB	A(C)CAH060LETB	A(C)CAH060LETB	A(C)CAH060LETB
A(C)CAH301LATB	A(C)CAH040LETB	A(C)CAH060LETB	A(C)CAH067LETB	A(C)CAH067LETB	A(C)CAH067LETB
A(C)CAH301LATB	A(C)CAH033LETB	A(C)CAH067LETB	A(C)CAH067LETB	A(C)CAH067LETB	A(C)CAH067LETB
A(C)CAH301LATB	A(C)CAH050LETB	A(C)CAH050LETB	A(C)CAH067LETB	A(C)CAH067LETB	A(C)CAH067LETB
A(C)CAH304LATB	A(C)CAH050LETB	A(C)CAH060LETB	A(C)CAH060LETB	A(C)CAH067LETB	A(C)CAH067LETB
A(C)CAH306LATB	A(C)CAH045LETB	A(C)CAH060LETB	A(C)CAH067LETB	A(C)CAH067LETB	A(C)CAH067LETB
A(C)CAH307LATB	A(C)CAH060LETB	A(C)CAH060LETB	A(C)CAH060LETB	A(C)CAH060LETB	A(C)CAH067LETB
A(C)CAH308LATB	A(C)CAH040LETB	A(C)CAH067LETB	A(C)CAH067LETB	A(C)CAH067LETB	A(C)CAH067LETB
A(C)CAH311LATB	A(C)CAH050LETB	A(C)CAH060LETB	A(C)CAH067LETB	A(C)CAH067LETB	A(C)CAH067LETB
A(C)CAH313LATB	A(C)CAH045LETB	A(C)CAH067LETB	A(C)CAH067LETB	A(C)CAH067LETB	A(C)CAH067LETB
A(C)CAH314LATB	A(C)CAH060LETB	A(C)CAH060LETB	A(C)CAH060LETB	A(C)CAH067LETB	A(C)CAH067LETB
A(C)CAH318LATB	A(C)CAH050LETB	A(C)CAH067LETB	A(C)CAH067LETB	A(C)CAH067LETB	A(C)CAH067LETB
A(C)CAH321LATB	A(C)CAH060LETB	A(C)CAH060LETB	A(C)CAH067LETB	A(C)CAH067LETB	A(C)CAH067LETB
A(C)CAH328LATB	A(C)CAH060LETB	A(C)CAH067LETB	A(C)CAH067LETB	A(C)CAH067LETB	A(C)CAH067LETB
A(C)CAH335LATB	A(C)CAH067LETB	A(C)CAH067LETB	A(C)CAH067LETB	A(C)CAH067LETB	A(C)CAH067LETB

Air-Cooled Scroll Chiller (R410A)

10. Installation of Chiller

■ 460 V

Set Model	Unit Combination				
ACAH020HETB	ACAH020HETB	-	-	-	-
ACAH023HETB	ACAH023HETB	-	-	-	-
ACAH033HETB	ACAH033HETB	-	-	-	-
ACAH040HETB	ACAH040HETB	-	-	-	-
ACAH043HATB	ACAH020HETB	ACAH023HETB	-	-	-
ACAH045HETB	ACAH045HETB	-	-	-	-
ACAH050HETB	ACAH050HETB	-	-	-	-
ACAH060HETB	ACAH060HETB	-	-	-	-
ACAH067HETB	ACAH067HETB	-	-	-	-
ACAH073HATB	ACAH033HETB	ACAH040HETB	-	-	-
ACAH080HATB	ACAH040HETB	ACAH040HETB	-	-	-
ACAH085HATB	ACAH040HETB	ACAH045HETB	-	-	-
ACAH090HATB	ACAH045HETB	ACAH045HETB	-	-	-
ACAH093HATB	ACAH033HETB	ACAH060HETB	-	-	-
ACAH100HATB	ACAH040HETB	ACAH060HETB	-	-	-
ACAH105HATB	ACAH045HETB	ACAH060HETB	-	-	-
ACAH107HATB	ACAH040HETB	ACAH067HETB	-	-	-
ACAH112HATB	ACAH045HETB	ACAH067HETB	-	-	-
ACAH117HATB	ACAH050HETB	ACAH067HETB	-	-	-
ACAH120HATB	ACAH060HETB	ACAH060HETB	-	-	-
ACAH127HATB	ACAH060HETB	ACAH067HETB	-	-	-
ACAH134HATB	ACAH067HETB	ACAH067HETB	-	-	-
ACAH135HATB	ACAH045HETB	ACAH045HETB	ACAH045HETB	-	-
ACAH140HATB	ACAH040HETB	ACAH040HETB	ACAH060HETB	-	-
ACAH140HATB	ACAH033HETB	ACAH040HETB	ACAH067HETB	-	-
ACAH140HATB	ACAH045HETB	ACAH045HETB	ACAH050HETB	-	-
ACAH147HATB	ACAH040HETB	ACAH040HETB	ACAH067HETB	-	-
ACAH150HATB	ACAH045HETB	ACAH045HETB	ACAH060HETB	-	-
ACAH152HATB	ACAH040HETB	ACAH045HETB	ACAH067HETB	-	-
ACAH157HATB	ACAH045HETB	ACAH045HETB	ACAH067HETB	-	-
ACAH157HATB	ACAH023HETB	ACAH067HETB	ACAH067HETB	-	-
ACAH160HATB	ACAH040HETB	ACAH060HETB	ACAH060HETB	-	-
ACAH165HATB	ACAH045HETB	ACAH060HETB	ACAH060HETB	-	-
ACAH167HATB	ACAH040HETB	ACAH060HETB	ACAH067HETB	-	-
ACAH170HATB	ACAH050HETB	ACAH060HETB	ACAH060HETB	-	-
ACAH172HATB	ACAH045HETB	ACAH060HETB	ACAH067HETB	-	-
ACAH174HATB	ACAH040HETB	ACAH067HETB	ACAH067HETB	-	-
ACAH175HATB	ACAH040HETB	ACAH045HETB	ACAH045HETB	ACAH045HETB	-
ACAH179HATB	ACAH045HETB	ACAH067HETB	ACAH067HETB	-	-
ACAH180HATB	ACAH060HETB	ACAH060HETB	ACAH060HETB	-	-

Air-Cooled Scroll Chiller (R410A)

10. Installation of Chiller

Set Model	Unit Combination				
ACAH180HATB	ACAH045HETB	ACAH045HETB	ACAH045HETB	ACAH045HETB	-
ACAH184HATB	ACAH050HETB	ACAH067HETB	ACAH067HETB	-	-
ACAH185HATB	ACAH045HETB	ACAH045HETB	ACAH045HETB	ACAH050HETB	-
ACAH187HATB	ACAH060HETB	ACAH060HETB	ACAH067HETB	-	-
ACAH187HATB	ACAH040HETB	ACAH040HETB	ACAH040HETB	ACAH067HETB	-
ACAH192HATB	ACAH040HETB	ACAH040HETB	ACAH045HETB	ACAH067HETB	-
ACAH194HATB	ACAH060HETB	ACAH067HETB	ACAH067HETB	-	-
ACAH197HATB	ACAH040HETB	ACAH045HETB	ACAH045HETB	ACAH067HETB	-
ACAH200HATB	ACAH040HETB	ACAH040HETB	ACAH060HETB	ACAH060HETB	-
ACAH200HATB	ACAH033HETB	ACAH040HETB	ACAH060HETB	ACAH067HETB	-
ACAH200HATB	ACAH020HETB	ACAH045HETB	ACAH045HETB	ACAH045HETB	ACAH045HETB
ACAH201HATB	ACAH067HETB	ACAH067HETB	ACAH067HETB	-	-
ACAH202HATB	ACAH045HETB	ACAH045HETB	ACAH045HETB	ACAH067HETB	-
ACAH202HATB	ACAH023HETB	ACAH045HETB	ACAH067HETB	ACAH067HETB	-
ACAH207HATB	ACAH040HETB	ACAH040HETB	ACAH060HETB	ACAH067HETB	-
ACAH210HATB	ACAH045HETB	ACAH045HETB	ACAH060HETB	ACAH060HETB	-
ACAH210HATB	ACAH040HETB	ACAH040HETB	ACAH040HETB	ACAH045HETB	ACAH045HETB
ACAH212HATB	ACAH040HETB	ACAH045HETB	ACAH060HETB	ACAH067HETB	-
ACAH214HATB	ACAH040HETB	ACAH040HETB	ACAH067HETB	ACAH067HETB	-
ACAH217HATB	ACAH045HETB	ACAH045HETB	ACAH060HETB	ACAH067HETB	-
ACAH217HATB	ACAH023HETB	ACAH060HETB	ACAH067HETB	ACAH067HETB	-
ACAH217HATB	ACAH020HETB	ACAH023HETB	ACAH040HETB	ACAH067HETB	ACAH067HETB
ACAH219HATB	ACAH040HETB	ACAH045HETB	ACAH067HETB	ACAH067HETB	-
ACAH220HATB	ACAH040HETB	ACAH045HETB	ACAH045HETB	ACAH045HETB	ACAH045HETB
ACAH222HATB	ACAH045HETB	ACAH050HETB	ACAH060HETB	ACAH067HETB	-
ACAH224HATB	ACAH045HETB	ACAH045HETB	ACAH067HETB	ACAH067HETB	-
ACAH224HATB	ACAH023HETB	ACAH067HETB	ACAH067HETB	ACAH067HETB	-
ACAH225HATB	ACAH045HETB	ACAH060HETB	ACAH060HETB	ACAH060HETB	-
ACAH225HATB	ACAH045HETB	ACAH045HETB	ACAH045HETB	ACAH045HETB	ACAH045HETB
ACAH227HATB	ACAH033HETB	ACAH060HETB	ACAH067HETB	ACAH067HETB	-
ACAH229HATB	ACAH045HETB	ACAH050HETB	ACAH067HETB	ACAH067HETB	-
ACAH232HATB	ACAH040HETB	ACAH040HETB	ACAH040HETB	ACAH045HETB	ACAH067HETB
ACAH233HATB	ACAH033HETB	ACAH033HETB	ACAH040HETB	ACAH060HETB	ACAH067HETB
ACAH234HATB	ACAH040HETB	ACAH060HETB	ACAH067HETB	ACAH067HETB	-
ACAH237HATB	ACAH040HETB	ACAH040HETB	ACAH045HETB	ACAH045HETB	ACAH067HETB
ACAH239HATB	ACAH045HETB	ACAH060HETB	ACAH067HETB	ACAH067HETB	-
ACAH240HATB	ACAH023HETB	ACAH045HETB	ACAH045HETB	ACAH060HETB	ACAH067HETB
ACAH240HATB	ACAH033HETB	ACAH033HETB	ACAH040HETB	ACAH067HETB	ACAH067HETB
ACAH241HATB	ACAH040HETB	ACAH067HETB	ACAH067HETB	ACAH067HETB	-
ACAH242HATB	ACAH040HETB	ACAH045HETB	ACAH045HETB	ACAH045HETB	ACAH067HETB

Air-Cooled Scroll Chiller (R410A)

10. Installation of Chiller

Set Model	Unit Combination				
ACAH244HATB	ACAH050HETB	ACAH060HETB	ACAH067HETB	ACAH067HETB	-
ACAH246HATB	ACAH045HETB	ACAH067HETB	ACAH067HETB	ACAH067HETB	-
ACAH247HATB	ACAH060HETB	ACAH060HETB	ACAH060HETB	ACAH067HETB	-
ACAH247HATB	ACAH045HETB	ACAH045HETB	ACAH045HETB	ACAH045HETB	ACAH067HETB
ACAH247HATB	ACAH023HETB	ACAH045HETB	ACAH045HETB	ACAH067HETB	ACAH067HETB
ACAH247HATB	ACAH040HETB	ACAH040HETB	ACAH040HETB	ACAH060HETB	ACAH067HETB
ACAH250HATB	ACAH033HETB	ACAH045HETB	ACAH045HETB	ACAH060HETB	ACAH067HETB
ACAH251HATB	ACAH050HETB	ACAH067HETB	ACAH067HETB	ACAH067HETB	-
ACAH252HATB	ACAH040HETB	ACAH040HETB	ACAH045HETB	ACAH060HETB	ACAH067HETB
ACAH252HATB	ACAH045HETB	ACAH045HETB	ACAH045HETB	ACAH050HETB	ACAH067HETB
ACAH254HATB	ACAH060HETB	ACAH060HETB	ACAH067HETB	ACAH067HETB	-
ACAH254HATB	ACAH040HETB	ACAH040HETB	ACAH040HETB	ACAH067HETB	ACAH067HETB
ACAH257HATB	ACAH040HETB	ACAH045HETB	ACAH045HETB	ACAH060HETB	ACAH067HETB
ACAH257HATB	ACAH033HETB	ACAH045HETB	ACAH045HETB	ACAH067HETB	ACAH067HETB
ACAH257HATB	ACAH023HETB	ACAH040HETB	ACAH060HETB	ACAH067HETB	ACAH067HETB
ACAH257HATB	ACAH023HETB	ACAH033HETB	ACAH067HETB	ACAH067HETB	ACAH067HETB
ACAH257HATB	ACAH045HETB	ACAH045HETB	ACAH050HETB	ACAH050HETB	ACAH067HETB
ACAH259HATB	ACAH040HETB	ACAH040HETB	ACAH045HETB	ACAH067HETB	ACAH067HETB
ACAH260HATB	ACAH033HETB	ACAH040HETB	ACAH060HETB	ACAH060HETB	ACAH067HETB
ACAH260HATB	ACAH023HETB	ACAH050HETB	ACAH060HETB	ACAH060HETB	ACAH067HETB
ACAH261HATB	ACAH060HETB	ACAH067HETB	ACAH067HETB	ACAH067HETB	-
ACAH262HATB	ACAH023HETB	ACAH045HETB	ACAH060HETB	ACAH067HETB	ACAH067HETB
ACAH264HATB	ACAH040HETB	ACAH045HETB	ACAH045HETB	ACAH067HETB	ACAH067HETB
ACAH264HATB	ACAH023HETB	ACAH040HETB	ACAH067HETB	ACAH067HETB	ACAH067HETB
ACAH267HATB	ACAH040HETB	ACAH040HETB	ACAH060HETB	ACAH060HETB	ACAH067HETB
ACAH267HATB	ACAH033HETB	ACAH040HETB	ACAH060HETB	ACAH067HETB	ACAH067HETB
ACAH267HATB	ACAH045HETB	ACAH045HETB	ACAH050HETB	ACAH060HETB	ACAH067HETB
ACAH267HATB	ACAH033HETB	ACAH033HETB	ACAH067HETB	ACAH067HETB	ACAH067HETB
ACAH267HATB	ACAH050HETB	ACAH050HETB	ACAH050HETB	ACAH050HETB	ACAH067HETB
ACAH268HATB	ACAH067HETB	ACAH067HETB	ACAH067HETB	ACAH067HETB	-
ACAH269HATB	ACAH045HETB	ACAH045HETB	ACAH045HETB	ACAH067HETB	ACAH067HETB
ACAH269HATB	ACAH023HETB	ACAH045HETB	ACAH067HETB	ACAH067HETB	ACAH067HETB
ACAH270HATB	ACAH045HETB	ACAH045HETB	ACAH060HETB	ACAH060HETB	ACAH060HETB
ACAH272HATB	ACAH040HETB	ACAH045HETB	ACAH060HETB	ACAH060HETB	ACAH067HETB
ACAH272HATB	ACAH033HETB	ACAH045HETB	ACAH060HETB	ACAH067HETB	ACAH067HETB
ACAH272HATB	ACAH045HETB	ACAH050HETB	ACAH050HETB	ACAH060HETB	ACAH067HETB
ACAH274HATB	ACAH040HETB	ACAH040HETB	ACAH060HETB	ACAH067HETB	ACAH067HETB
ACAH274HATB	ACAH045HETB	ACAH045HETB	ACAH050HETB	ACAH067HETB	ACAH067HETB
ACAH274HATB	ACAH023HETB	ACAH050HETB	ACAH067HETB	ACAH067HETB	ACAH067HETB
ACAH277HATB	ACAH045HETB	ACAH045HETB	ACAH060HETB	ACAH060HETB	ACAH067HETB

Air-Cooled Scroll Chiller (R410A)

10. Installation of Chiller

Set Model	Unit Combination				
ACAH279HATB	ACAH040HETB	ACAH045HETB	ACAH060HETB	ACAH067HETB	ACAH067HETB
ACAH279HATB	ACAH033HETB	ACAH045HETB	ACAH067HETB	ACAH067HETB	ACAH067HETB
ACAH279HATB	ACAH045HETB	ACAH050HETB	ACAH050HETB	ACAH067HETB	ACAH067HETB
ACAH280HATB	ACAH050HETB	ACAH050HETB	ACAH060HETB	ACAH060HETB	ACAH060HETB
ACAH281HATB	ACAH040HETB	ACAH040HETB	ACAH067HETB	ACAH067HETB	ACAH067HETB
ACAH282HATB	ACAH045HETB	ACAH050HETB	ACAH060HETB	ACAH060HETB	ACAH067HETB
ACAH284HATB	ACAH045HETB	ACAH045HETB	ACAH060HETB	ACAH067HETB	ACAH067HETB
ACAH284HATB	ACAH023HETB	ACAH060HETB	ACAH067HETB	ACAH067HETB	ACAH067HETB
ACAH284HATB	ACAH033HETB	ACAH050HETB	ACAH067HETB	ACAH067HETB	ACAH067HETB
ACAH285HATB	ACAH045HETB	ACAH060HETB	ACAH060HETB	ACAH060HETB	ACAH060HETB
ACAH286HATB	ACAH040HETB	ACAH045HETB	ACAH067HETB	ACAH067HETB	ACAH067HETB
ACAH287HATB	ACAH040HETB	ACAH060HETB	ACAH060HETB	ACAH060HETB	ACAH067HETB
ACAH287HATB	ACAH033HETB	ACAH060HETB	ACAH060HETB	ACAH067HETB	ACAH067HETB
ACAH287HATB	ACAH050HETB	ACAH050HETB	ACAH060HETB	ACAH060HETB	ACAH067HETB
ACAH289HATB	ACAH045HETB	ACAH050HETB	ACAH060HETB	ACAH067HETB	ACAH067HETB
ACAH291HATB	ACAH045HETB	ACAH045HETB	ACAH067HETB	ACAH067HETB	ACAH067HETB
ACAH291HATB	ACAH023HETB	ACAH067HETB	ACAH067HETB	ACAH067HETB	ACAH067HETB
ACAH292HATB	ACAH045HETB	ACAH060HETB	ACAH060HETB	ACAH060HETB	ACAH067HETB
ACAH294HATB	ACAH040HETB	ACAH060HETB	ACAH060HETB	ACAH067HETB	ACAH067HETB
ACAH294HATB	ACAH033HETB	ACAH060HETB	ACAH067HETB	ACAH067HETB	ACAH067HETB
ACAH294HATB	ACAH050HETB	ACAH050HETB	ACAH060HETB	ACAH067HETB	ACAH067HETB
ACAH296HATB	ACAH045HETB	ACAH050HETB	ACAH067HETB	ACAH067HETB	ACAH067HETB
ACAH299HATB	ACAH045HETB	ACAH060HETB	ACAH060HETB	ACAH067HETB	ACAH067HETB
ACAH300HATB	ACAH060HETB	ACAH060HETB	ACAH060HETB	ACAH060HETB	ACAH060HETB
ACAH301HATB	ACAH040HETB	ACAH060HETB	ACAH067HETB	ACAH067HETB	ACAH067HETB
ACAH301HATB	ACAH033HETB	ACAH067HETB	ACAH067HETB	ACAH067HETB	ACAH067HETB
ACAH301HATB	ACAH050HETB	ACAH050HETB	ACAH067HETB	ACAH067HETB	ACAH067HETB
ACAH304HATB	ACAH050HETB	ACAH060HETB	ACAH060HETB	ACAH067HETB	ACAH067HETB
ACAH306HATB	ACAH045HETB	ACAH060HETB	ACAH067HETB	ACAH067HETB	ACAH067HETB
ACAH307HATB	ACAH060HETB	ACAH060HETB	ACAH060HETB	ACAH060HETB	ACAH067HETB
ACAH308HATB	ACAH040HETB	ACAH067HETB	ACAH067HETB	ACAH067HETB	ACAH067HETB
ACAH311HATB	ACAH050HETB	ACAH060HETB	ACAH067HETB	ACAH067HETB	ACAH067HETB
ACAH313HATB	ACAH045HETB	ACAH067HETB	ACAH067HETB	ACAH067HETB	ACAH067HETB
ACAH314HATB	ACAH060HETB	ACAH060HETB	ACAH060HETB	ACAH067HETB	ACAH067HETB
ACAH318HATB	ACAH050HETB	ACAH067HETB	ACAH067HETB	ACAH067HETB	ACAH067HETB
ACAH321HATB	ACAH060HETB	ACAH060HETB	ACAH067HETB	ACAH067HETB	ACAH067HETB
ACAH328HATB	ACAH060HETB	ACAH067HETB	ACAH067HETB	ACAH067HETB	ACAH067HETB
ACAH335HATB	ACAH067HETB	ACAH067HETB	ACAH067HETB	ACAH067HETB	ACAH067HETB

11. Specification of Production

Manufacturing specification

- 1) Use the parts and material of KS standard products or equivalent products for those not specified in this specification, and all parts should be designed with structure that is easy for replacement, repair, and inspection.
- 2) If there is a problem in the chiller, or if there is an abnormal status of chilled water temperature and flow amount, etc., immediately stop the chiller operation and you have to be equipped with marking equipment or function that can easily identify these.
- 3) There should be a protection circuit to prevent freezer damage by blackout or frequent voltage variation from Electronic Power company.
- 4) Chiller should be able to operate silently without abnormal noise or abnormal vibration.
- 5) Chiller should be composed of the central controller and the circuit possible for wired/wireless Start/Stop operation.
- 6) Easy combination should be possible with compact product design and module type design, and basic module insertion and assembly installation should be possible regardless of the volume.
- 7) It should be the structure possible for substitute operation even if compressor or some cycle parts fail and cooling operation should be possible during parts replacement, repair, or inspection.
- 8) The main power cable equivalent or above the specification presented in the product specification of each corresponding model should be used for the chiller, each communication line and power cable should use cable pipe for protection, and the cable pipe with the material that can block external noise according to the installation environment should be used.

Air cooled type scroll chiller product specification

1. Case

- 1) It should have the structure that is easy for disassembly and assembly for easy maintenance/repair.
- 2) It should have a beautiful exterior and it should be insulated to prevent dew condensation.
- 3) It should have the structure preventing vibration and abnormal noise.
- 4) It should have the structure that can be grounded.

2. Compressor

- 1) R410A refrigerant should be used, case shape should be sealed type, format should be the combination of two inverter scroll compressors, it should be flexible to respond to load, and it should be a high efficiency system that can optimize energy efficiency through inverter control.
- 2) Vibration prevention rubber should be used to prevent transfer of noise and vibration during operation.
- 3) The frequency variable boundary of inverter scroll compressor should be minimum 30Hz and maximum 130Hz.

3. Condenser

- 1) Condenser heat pipe should use purity 99.9 % or above Phosphorus Deoxidized Copper without joint, and it should have the structure with Al fin attached to increase the heating area. (Cross fin & Tube type)
- 2) Use wide louver fin for Al fin, and pipe extension should be carried out for efficient heat transfer.
- 3) Condenser air cooled type heat exchanger arrangement should be 3 rows 48 levels 14FPI.
- 4) The pressure endurance test for high pressure part refrigerant side should be carried out at 4.18 MPa or above (designed pressure 3.8 MPa), and there should be problems such as leakage or deformation.

Air-Cooled Scroll Chiller (R410A)

11. Specification of Production

- 5) The condensing coil that passed pressure endurance test should be vacuumed to completely remove moisture inside.
- 6) Use propeller type Fan, and it should be able to give sufficient wind amount required for condensing. Also, it should have sufficient strength for the number of rotations, and it should be operated silently through balance test.
- 7) Motor should be BLDC type that can increase efficiency.
- 8) Fan and Motor should be connected directly.

4. Electronic Expansion Valve

- 1) It is the part that insulates and expands high pressure fluid refrigerant at condenser exit in low temperature • low pressure state, and during cooling operation, line shape electronic expansion valve should be activated to adjust adequate refrigerant amount according to the evaporator load.
- 2) Based on data of various sensors installed in the freezer, microcomputer unit should be able to analyze operation status of the system and compressor to control the most adequate refrigerant amount linearly.
- 3) By applying electric pulse signal to stepping motor, it should be able to play the role of adjusting the refrigerant flow amount.

5. Evaporator

- 1) Evaporator should be Shell & tube type heat exchanger type, and the material should be carbon steel.
- 2) There should be no water leakage, and the durability should be guaranteed.
- 3) It should have the structure that can connect to chilled water pipe.
- 4) Heat exchanger should be sensible heat exchange structure that the refrigerant and coolant are not mixed.
- 5) It should be a structure that each of coolant and refrigerant are flown into countercurrent structure heat exchanger and after heat is exchanged with each other through the thin valve inside heat exchanger, discharged outside heat exchanger.

6. Control equipment

- 1) It is the controller to operate overall system in optimal condition with the microcomputer unit installed in the freezer, and based on the 4 measurement values including intake refrigerant gas pressure, discharged refrigerant gas pressure, discharged refrigerant gas temperature, and heat exchanger refrigerant temperature, it should be able to control electronic expansion valve, compressor(inverter), etc.
- 2) There should be a function that can check all sensors connected to the freezer and various operation statuses.
- 3) It should be equipped with self protection equipment and system protection function.
- 4) Module type control interface should be applied so that simple product control is possible in series installation, and relocation and re-installation of HMI controller should be possible without separate control equipment.

7. Ref. Piping

- 1) Refrigerant pipe should be purity 99.9% or above Phosphorus Deoxidized Copper without joint, and it should be piped for fluent refrigerant flow between each component.
- 2) Install strainer in the pipe to filter foreign objects.
- 3) The pipe from expansion valve to evaporator should be insulated to prevent moisture condensation on the surface of the pipe and to prevent flash gas generation of refrigerant fluid at the same time.
- 4) Liquid injection pipe that activates electronic valve to flow fluid refrigerant to the suction pipe when discharged gas temperature is above the rated temperature should be installed to protect compressor and freezer.
- 5) After completing the piping, carry out the pressure endurance test on refrigerant side at 4.18 MPa or above (designed pressure 3.8 MPa), and there should be no leakage or deformation.
- 6) After carrying out air-tight test, completely vacuum inside so that there is absolutely no moisture.

Air-Cooled Scroll Chiller (R410A)

11. Specification of Production

8. Safety devices

- 1) Refrigerant pressure (Normal refrigerant pressure)
 - A. High pressure switch
 - B. High voltage protection (Sensor)
- 2) Temperature
 - A. compressor discharge temperature overheating detection (Sensor)
 - B. IPM temperature detection (Sensor)
 - C. Freeze and burst protection (Sensor)
 - D. Power Module application (Sensor)
- 3) Chilled water flow
 - A. Chilled water flow switch (Field wiring)
- 4) Voltage and current (control logic)
 - A. Revere phase detection and protection (Voltage monitoring system)
 - B. Compressor over-current protection
 - C. Fan motor over-current protection
- 5) Fuse

Accessory list

1	PACP5A000 (ACP 5 Central Control)
---	-----------------------------------

Air-Cooled Scroll Chiller (R410A)

12. Appendix – Piping Diagram

■ 1 Unit

A(C)CAH020VETB, A(C)CAH020LETB, A(C)CAH023LETB,
 ACAH020HETB, ACAH023HETB

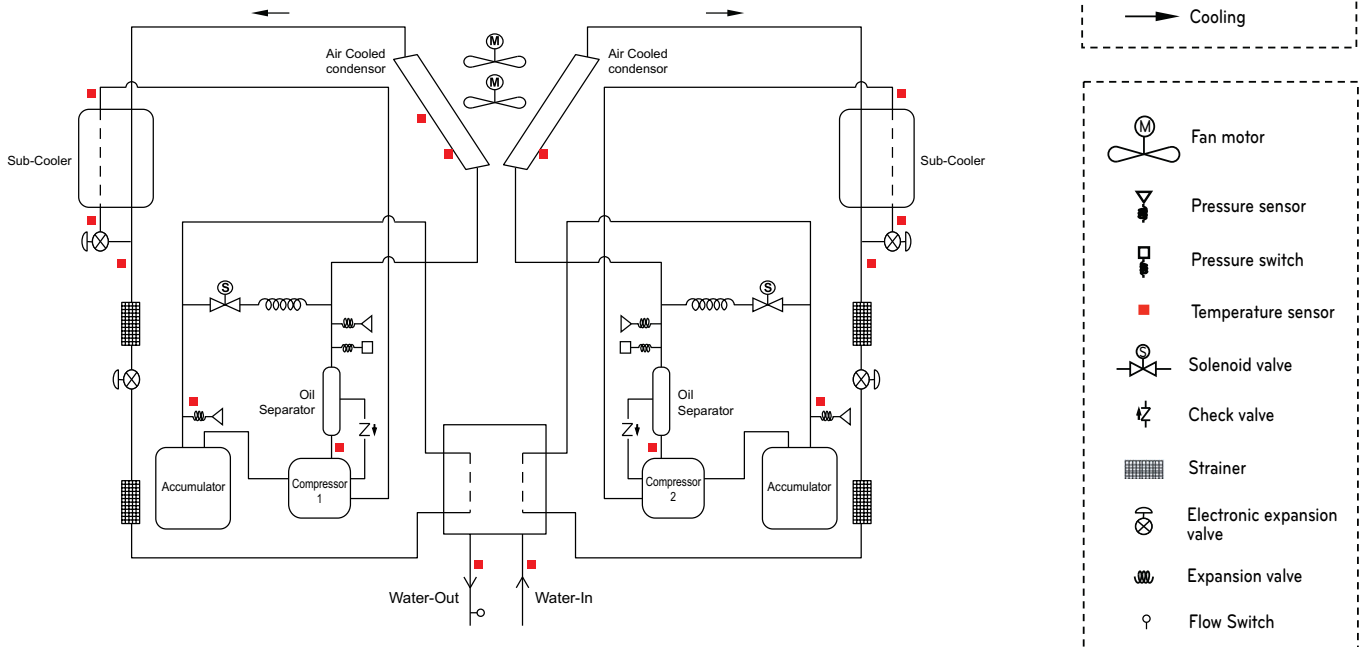

Air-Cooled Scroll Chiller (R410A)

12. Appendix – Piping Diagram

■ 2 Unit

A(C)CAH033VETB, A(C)CAH040VETB,
 A(C)CAH033LETB, A(C)CAH040LETB, A(C)CAH045LETB,
 ACAH033HETB, ACAH040HETB, ACAH045HETB

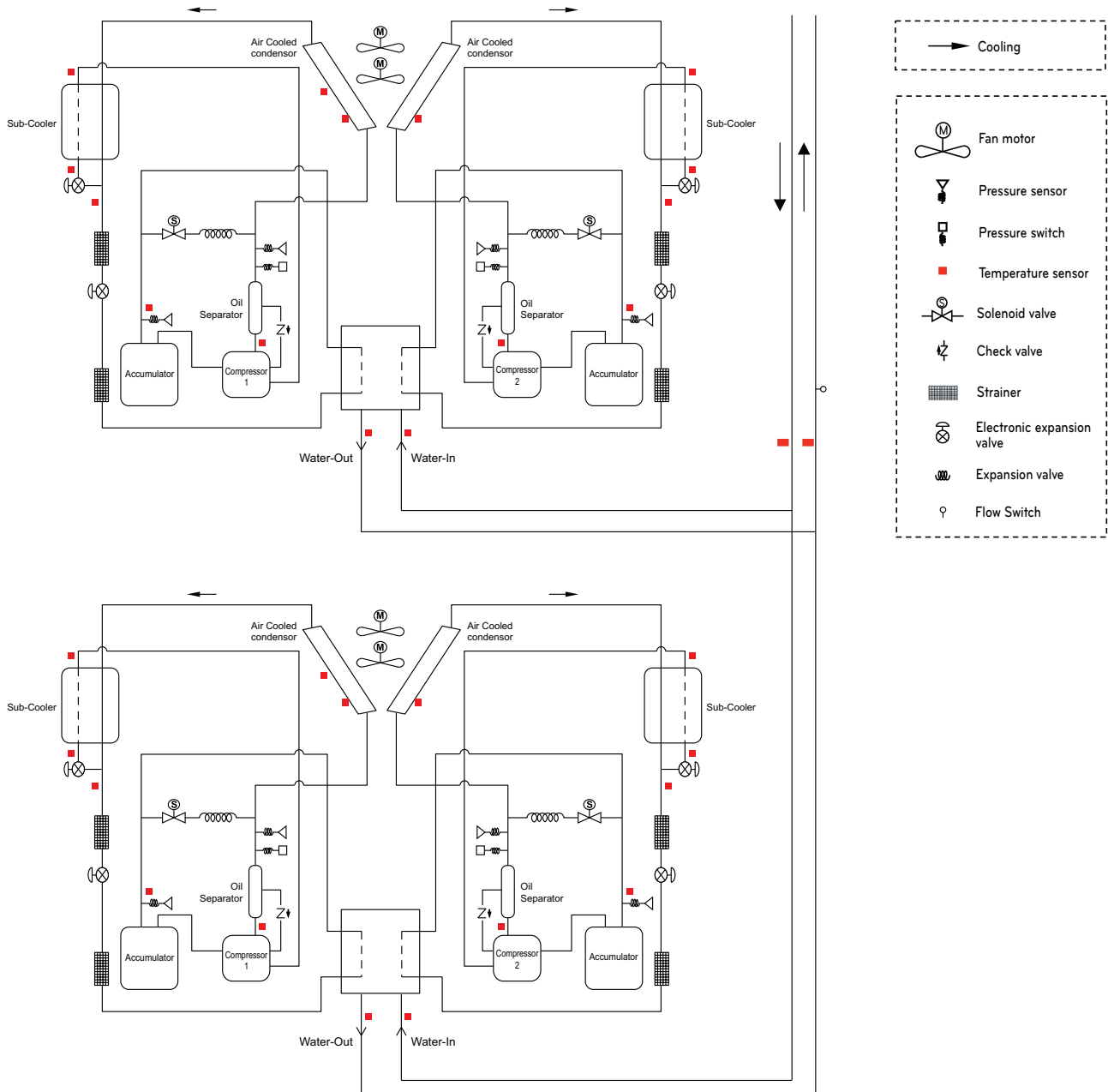

Air-Cooled Scroll Chiller (R410A)

12. Appendix – Piping Diagram

3Unit

A(C)CAH050VETB, A(C)CAH060VETB,
 A(C)CAH050LETB, A(C)CAH060LETB, A(C)CAH067LETB,
 ACAH050HETB, ACAH060HETB, ACAH067HETB

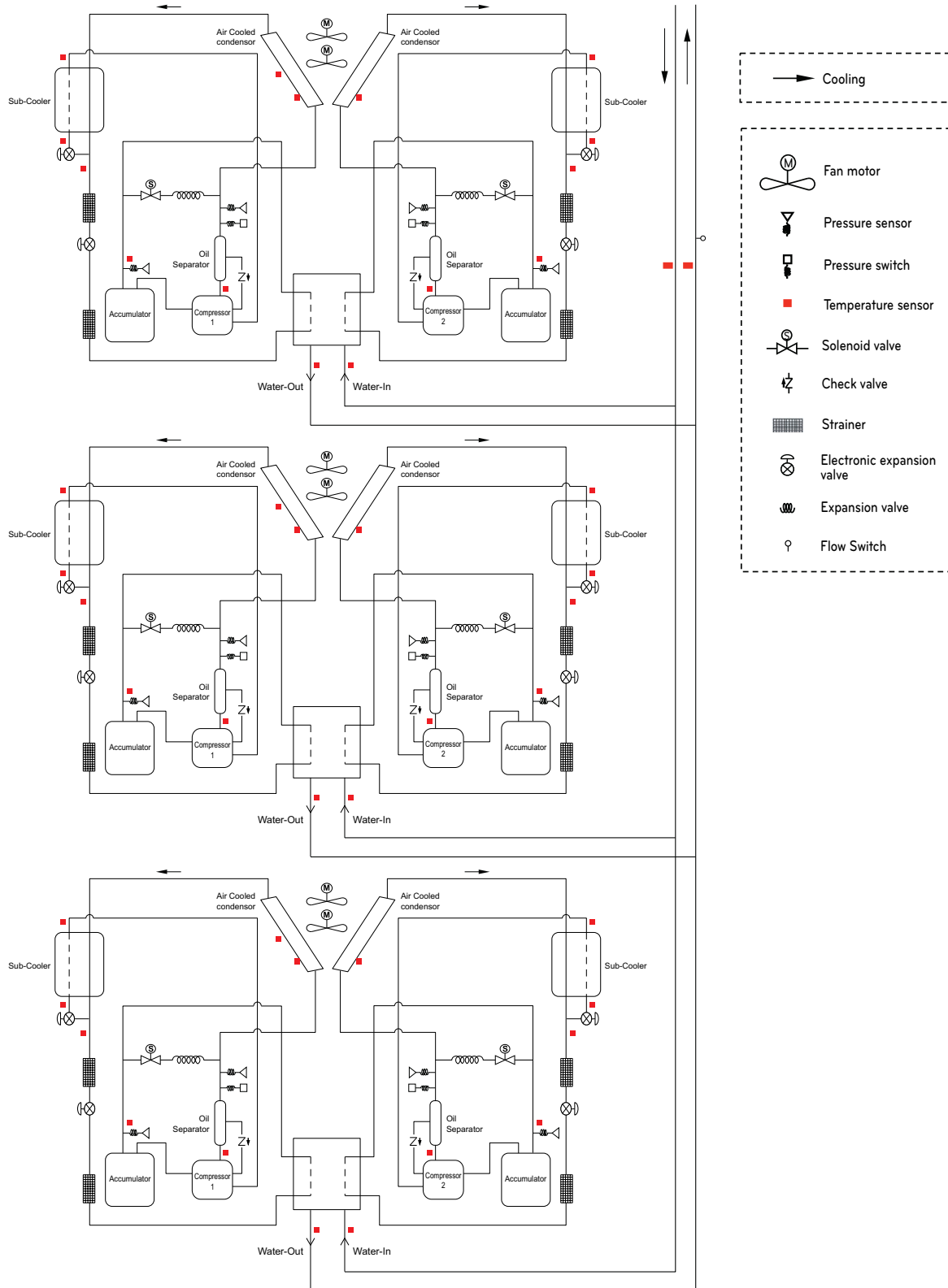

Air-Cooled Scroll Chiller (R410A)

13. Appendix - Standard acquisition

Product	Target	Standard	
	Region	AHRI	CSA
A(C)CAH***VETB(208~230V)	Global	O	O
A(C)CAH***LETB(380~415V)	Global	O	X
ACAH***HETB(460V)	Global	O	O

* ACAH033/040/045/050/060/067LETB are certified CU for Russia region(Russia and kazakstan).



P/No.: MFL67285211



Air Solution

LG Electronics Inc, 128, Yeoui-daero,
Yeongdeungpo-gu, Seoul, Korea
(07336)
<http://partner.lge.com>

Copyright © 2019 - 2023 LG
Electronics Inc. All Rights Reserved.
Printed in Korea September / 2023

The air conditioners manufactured by LG have received ISO9001 certificate for quality assurance and ISO14001 certificate for environmental management system.
The specifications, designs, and information in this brochure are subject to change without notice.