

# LG

**MULTI V**<sup>TM</sup>

Hydro Kit

R410A(50Hz/60Hz)

0CVG0-01H(Replaces 0CVG0-01G)

# TOTAL HVAC

# SOLUTION

# PROVIDER

## ENGINEERING PRODUCT DATA BOOK

**MULTI V**<sup>TM</sup>  
Hydro Kit

**General information**

**Floor Standing (Medium Temperature)**

**Floor Standing (High Temperature)**

**Installation**

***MULTI V***<sup>TM</sup>  
Hydro Kit

**General information**



- 1. Model Names & External Appearance**
- 2. Nomenclature**
- 3. Indoor Unit Capacity Index & Combination Ratio**

# 1. Model Names & External Appearance

## ■ Model Names

Category	Operating Temperature	Chassis Name	4 HP	8 HP	10 HP
Floor standing	Medium	K2	ARNH04GK2A4	-	ARNH10GK2A4
	High	K3	ARNH04GK3A4	ARNH08GK3A4	-

## ■ External Appearance

Category	Operating Temperature	Chassis Name	Model Name	Refrigerant	Model
Floor standing	Medium	K2	ARNH04GK2A4 ARNH10GK2A4	R410A / R32	
	High	K3	ARNH04GK3A4 ARNH08GK3A4	R410A / R32	

## 2. Nomenclature

Model Name	ARN	H	10	G	K2	A	4
No.	1	2	3	4	5	6	7

No.	Signification
1	<b>Indoor Unit for Multi V System using R410a</b>
2	<b>Type of indoor unit</b> U : Regular indoor H : Hydro Kit
3	<b>Capacity (HP)</b> Ex) 4 HP → '04', 8 HP → '8'
4	<b>Electrical Ratings</b> 1 : 1Ø, 115V, 60Hz 2 : 1Ø, 220V, 60Hz 3 : 1Ø, 208/230V, 60Hz 6 : 1Ø, 220 - 240V, 50Hz 7 : 1Ø, 100V, 50/60Hz G: 1Ø, 220-240V, 50Hz / 1Ø, 220V, 60Hz
5	<b>Chassis Name</b>
6	<b>Combinations of functions</b> A: Basic function
7	<b>Serial Number</b>

### 3. Indoor Unit Capacity Index & Combination Ratio

#### Indoor Unit Capacity Index

##### Floor Standing

Model	ARNH04GK2A4 ARNH04GK3A4	ARNH08GK3A4	ARNH10GK2A4
Capacity Index	12.3	22.4	28.0

#### Note

- Capacity Index is based on cooling capacity(kW).
- High Temperature Hydro kit Capacity index is different from the heating capacity.

#### ODU-IDU Compatibility

Line up	Outdoor Unit Type	Normal Indoor Units	Special Indoor Units <sup>1)</sup>					
			Hydro Kit <sup>2)</sup>		Fresh Air Intake Unit (FAU)	ERV DX	AHU Comm. Kit & EEV Kit	
			Floor standing				Return (Room) air	Discharge (Supply) air
			Med. Temp	High Temp				
Multi V 5	Heat Pump & Heat Recovery	O	O	O	O	O	O	O (HP*only)
	Heat Pump	O	O	O	O	O	O	O
	Pro	O	X	X	O	O	O	O
	Cooling Only	O	O	X	O	O	O	O
	Tropical High Efficiency	O	O	O	O	O	O	O
	Tropical Standard	O	O	O	O	O	O	O
	Tropical Pro	O	X	X	O	O	O	O
Multi V S	R410A Heat Pump	O	O	O	O	O	O	O
	R410A Heat Recovery	O	O	O	X	O	O	X
	R410A Cooling Only	O	O	X	X	X	X	X
	Tropical	O	O	O	O	O	O	O
Multi V Water IV	Heat Pump	O	O	O	O	O	O	O
	Heat Recovery	O	O	O	X	O	O	X
MULTI V M	MULTI V M <sup>3)</sup>	O	X	X	X	X	X	X

#### Combination Ratio for System with Special Indoor Units

Type	Hydro Kit <sup>2)</sup>	ERV DX	Fresh Air Intake Unit (FAU)	AHU Comm. Kit & EEV Kit <sup>4)</sup>	
				in Heat Recovery or Return Air Mixing AHU	in Fresh Air AHU
1 ODU : 1 IDU		50 ~ 105%			
One ODU with normal IDUs and Special IDUs	Total (Normal IDUs + Special IDUs)	Refer to 'Combination Ratio for System with Normal Indoor Units' in outdoor unit PDB	50 ~ 105%	50 ~ 130 %	50 ~ 105%
	Max. Special IDUs		~ 105%	~ 50% (~100% : With cooling only ODU)	~ 50%
One ODU with Multiple Special IDUs only (no normal IDUs)	50 ~ 105%		50 ~ 105%	50 ~ 130 %	50 ~ 105%

#### Note

- Special Indoor Unit : Hydro Kit, FAU, ERV DX, AHU Comm. Kit & EEV kit, Water. Comm. Module & EEV Kit.  
If more than 2 types of special IDUs are connected, total combination ratio follows the small one.
- Hydro Kit cannot be combined with Multi V quadruple frame (4 units) system.
- Special Indoor Units cannot be combined with Multi V M.
- The combination ratio for systems with AHU Comm. Kit & EEV kit is determined by: (heat exchanger capacity + indoor unit nominal capacity index) / outdoor unit nominal cooling capacity. The on-coil temperature (i.e. coil inlet temperature) of Heat Recovery AHU should be within the operation range of the indoor units.  
For more detail about AHU comm. Kit application, please refer to AHU Comm. Kit PDB.
- \* : Heat Pump

## **Floor Standing (Medium Temperature)**

- 1. List of functions**
- 2. Specifications**
- 3. Dimensions**
- 4. Piping diagrams**
- 5. Wiring diagrams**
- 6. Capacity correction factor**
- 7. Water pressure drop**
- 8. Operation limits**
- 9. Electric characteristics**
- 10. Sound levels**

# 1. List of functions

## Basic functions of Unit

Category	Functions	ARNH04GK2A4 / ARNH10GK2A4
Installation	Drain pump	X
	E.S.P. control	X
	Electric heater (operation)	X
	High ceiling operation	X
Reliability	Hot start	X
	Self diagnosis	O
	Soft dry operation	X
Convenience	Auto changeover	X
	Auto cleaning	X
	Auto operation (artificial intelligence)	X
	Auto restart operation	O
	Child lock	O
	Forced operation	X
	Group control	O
	Sleep mode	X
	Timer (on/off)	O
	Timer (weekly)	O
Individual control	Two thermistor control	X
	Standard wired remote controller	O
	Premium wired remote controller	X
	Simple wired remote controller	X
	Simple Wired remote controller(for hotel use)	X
Network function	Wireless remote controller(simple)	X
	General central controller (Non LGAP)	X
Hydro Kit Functions	Network Solution (LGAP)	O
	Anti-Condensation on floor (cooling)	O
	Water Pump ON / OFF Control	O
	Water Flow Detection	O
	Thermostat Interface (230V AC)	O
	Thermostat Interface (24V AC)	O
	DHW(Domestic Hot Water) tank kit	X
	PHEX Anti-Freezing Control	O
	Water Pump Forced Operation	O
	Autosetting according to Ambient Temperature (for heating operation)	O
	Silent Operation	X
	Anti-overheating of Water Pipe	O
	Emergency Operation	O
	Weather Dependent Operation with Thermostat	X
	Scheduler (Domestic Hot Water Tank Heater)	X
	Timer (Domestic Hot Water Tank Heater)	X
	Quick Domestic Hot Water Tank Heating	O
	Electric Heater Capacity Control	X
	Screed Drying Mode	X
	Sump Heater	X
	One Point Dry Contact Input(CN-EXT)	O
	Tank Disinfection	X
	Pump Frequency	O
SG Ready	X	
ODU Cycle Priority (Heating Priority)	O	

### Note

1. O : Applied, X : Not applied

Accessory : Ordered and purchased separately the accessory package referring to the model name provided and install at field.

Accessory line-ups varies by region, so check your local catalogue or local sales material.



# 1. List of functions

## ■ Accessory Compatibility List

Category		Product	ETC	ARNH04GK2A4 ARNH10GK2A4
Central Controller	Simple	PQCSZ250S0	AC EZ	X
	AC Ez Touch	PACEZA000	AC Ez Touch	O
	AC Smart	PACS4B000	AC Smart IV	O
		PACS5A000	AC Smart 5	O
	ACP	PACP4B000	ACP IV	O
		PACP5A000	ACP 5	O
AC Manager	PACM4B000	AC Manager IV	O	
	PACM5A000	AC Manager 5	O	
Gateway	BACnet	PQNFB17C0	ACP BACnet	O
	Lonworks	PLNWKB000	ACP Lonworks	O
	Modbus	PMBUSB00A	Modbus Gateway	O
Dry contact	Simple Contact	PDRYCB000 PDRYCB100	Simple Dry Contact	O
		Communication type	PDRYCB400	2 Points Dry Contact (For Setback)
	PDRYCB300		Dry Contact For 3rd Party Thermostat	O
	PDRYCB500		Dry Contact For Modbus	X
ETC	Remote temperature sensor	PQRSTA0	-	O
	Zone controller	ABZCA	-	X
	Group control wire	PZCWRCG3	0.25m	O
	Wi-Fi Controller	PWFMD200	-	O
	Multi-Tenant Power Module	PINPMB001	-	O
	Refrigerant Leakage Detector	PRLDNVS0	-	O
	PDI	PPWRDB000	PDI Standard	O
PQNUD1S40		PDI Premium	O	
Special Kit for Hydrokit	Solar-Thermal Interface kit with DHW Tank	PHLLA	Limit Temperature : 96 °C	O
	Indoor Drain Pan	PHDPB	-	X

### Note

1. O : Applied, X : Not applied

Accessory model name : Installed at field, ordered and purchased separately by the corresponding model name, supplied with separated package.

2. If you need more detail, please refer to the BECON PDB or the manual of product.

(<http://partner.lge.com/global> : Home> Doc.Library> Product > Control(BECON))

## 2. Specifications

Model			Unit	ARNH04GK2A4	ARNH10GK2A4
Capacity (Rated)	Cooling		kW	12.3	28.0
			kcal/h	10,580	24,100
			Btu/h	42,000	95,900
	Heating		kW	13.8	31.5
			kcal/h	11,870	27,100
			Btu/h	47,000	107,500
Input (Rated)		Cooling	kW	0.01	0.01
		Heating	kW	0.01	0.01
Casing		Material	-	Painted Steel Plate	Painted Steel Plate
		Color (RAL code)	-	RAL 7030	
Dimensions	Net	Body (W x H x D)	mm	520 x 631 x 330	520 x 631 x 330
			inch	20-15/32 x 24-27/32 x 13	20-15/32 x 24-27/32 x 13
Weight	Net	Body	kg (lbs)	30.5(67.2)	35.5(78.3)
Heat Exchanger	Refrigerant to Water	Type	-	Brazed Plate HEX	Brazed Plate HEX
		Quantity	EA	1	1
		Number of Plate	EA	26	48
		Rated Water Flow	ℓ / min	39.6	92.0
		Head Loss	kPa	41.0	69.0
Temperature Control			-	Microprocessor, Thermostat for cooling and heating	
Water Tank Temperature Sensor		Type(Sensor Holder)	inch	Male PT 1/2	
		Length	m	12	
Sound Absorbing Thermal Insulation Material			-	Foamed polystyrene	Foamed polystyrene
Safety Device			-	Fuse	Fuse
Piping Connections	Water Side	Inlet	inch	Male PT 1	Male PT 1
		Outlet	inch	Male PT 1	Male PT 1
	Refrigerant Side	Liquid	mm(inch)	Ø 9.52(3/8)	Ø 9.52(3/8)
		Gas	mm(inch)	Ø 15.88(5/8)	Ø 22.2(7/8)
Drain Piping Connection			inch	Male PT 1	Male PT 1
Sound Pressure Level		Cooling	dB(A)	26	26
		Heating	dB(A)	26	26
Transmission Cable			mm <sup>2</sup>	1.0~1.5 × 2C	1.0~1.5 × 2C
Refrigerant	Refrigerant to Water	Refrigerant name	-	R410A	R410A
		Precharged Amount	kg (lbs)	-	-
		Additional Refrigerant Charge Amount	kg (lbs)	0.8(1.8)	1.6 (3.5)
		GWP (Global Warming Potential)	-	2,087.5	2,087.5
		t-CO2 eq	-	-	-
		Control	-	Electronic Expansion Valve	Electronic Expansion Valve
Power Supply			V, Ø, Hz	220-230-240, 1, 50/60	220-230-240, 1, 50/60
Running Current		Cooling / Heating	A	0.05 - 0.05 - 0.05	0.05 - 0.05 - 0.05

### Note

- Capacities are based on the following conditions:
  - Cooling Temperature : Outdoor 35°C(95°F) DB / 24°C(75.2°F) WB, Water Inlet 23°C(73.4°F) / Outlet 18°C(64.4°F)
  - Heating Temperature : Outdoor 7°C(44.6°F) DB / 6°C(42.8°F) WB, Water Inlet 30°C(86°F) / Outlet 35°C(95°F)
  - Difference Limit of Elevation (Outdoor ~ Indoor Unit) is 0m.
  - Piping Length : Interconnected Pipe Length = 7.5m
- Wiring cable size must comply with the applicable local and national code
- Due to our policy of innovation, some specifications may be changed without notification.
- Sound pressure level is measured on the rated condition in the anechoic rooms by ISO 3745 standard. Therefore, these values can be increased owing to ambient conditions during operation.
- This product contains Fluorinated greenhouse gases.(R410A,GWP(Global warming potential) = 2087.5)

### 3. Dimensions

#### ■ ARNH04GK2A4 / ARNH10GK2A4

[Unit: mm]  
 Chassis : K2  
 DWG NO. : TBJ37334301\_rev02

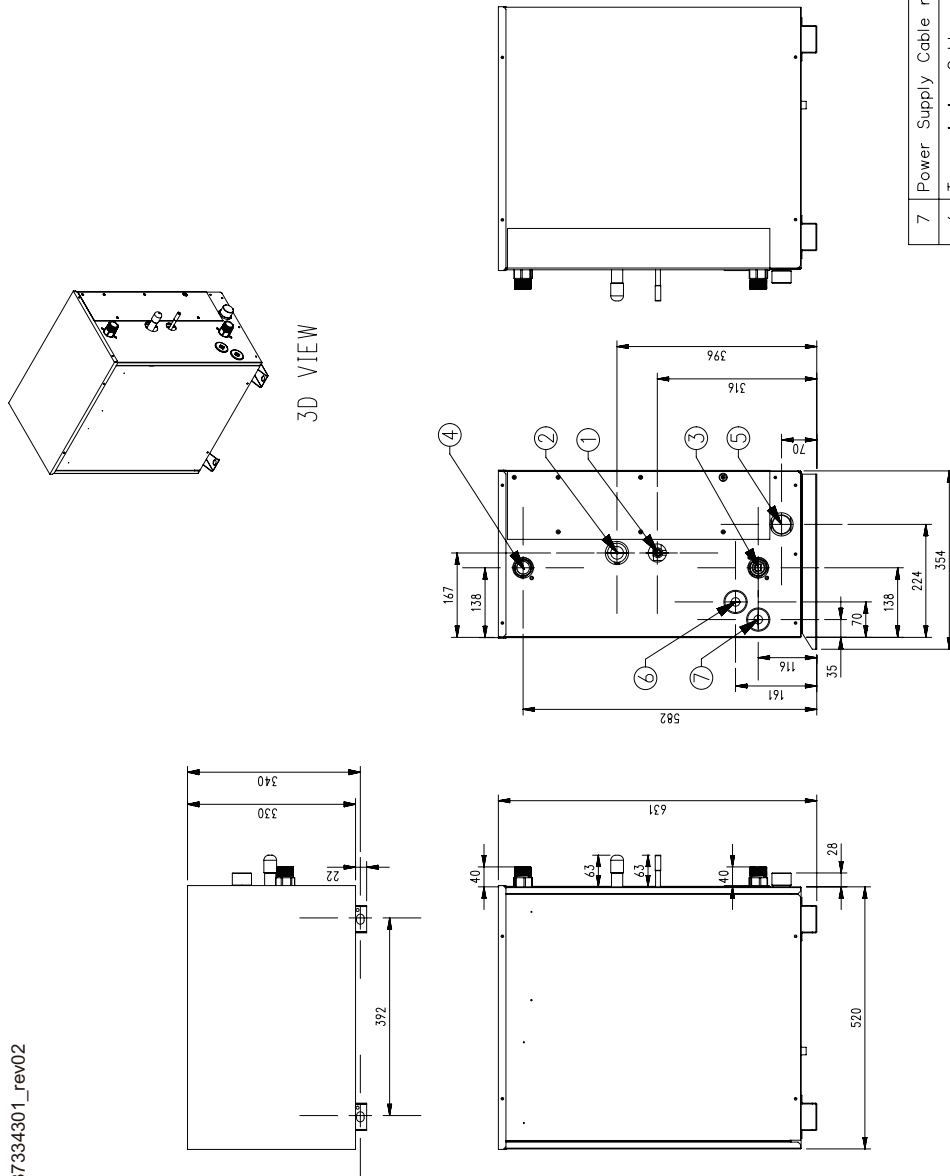

3D VIEW

Note  
 1. Unit should be installed in compliance with the installation manual in the product box.  
 2. Unit should be grounded in accordance with the local regulations or applicable national codes.  
 3. All electrical components and materials to be supplied from the site must comply with the local regulations or international codes.

7	Power Supply Cable routing Hole	Ø 30
6	Transmission Cable routing Hole	Ø 30
5	Drain Pipe	-
4	Water Outlet	-
3	Water Inlet	-
2	Gas Pipe	-
1	Liquid Pipe	-
No.	Part Name	Description

# 4. Piping diagrams

## ■ ARNH04GK2A4 / ARNH10GK2A4

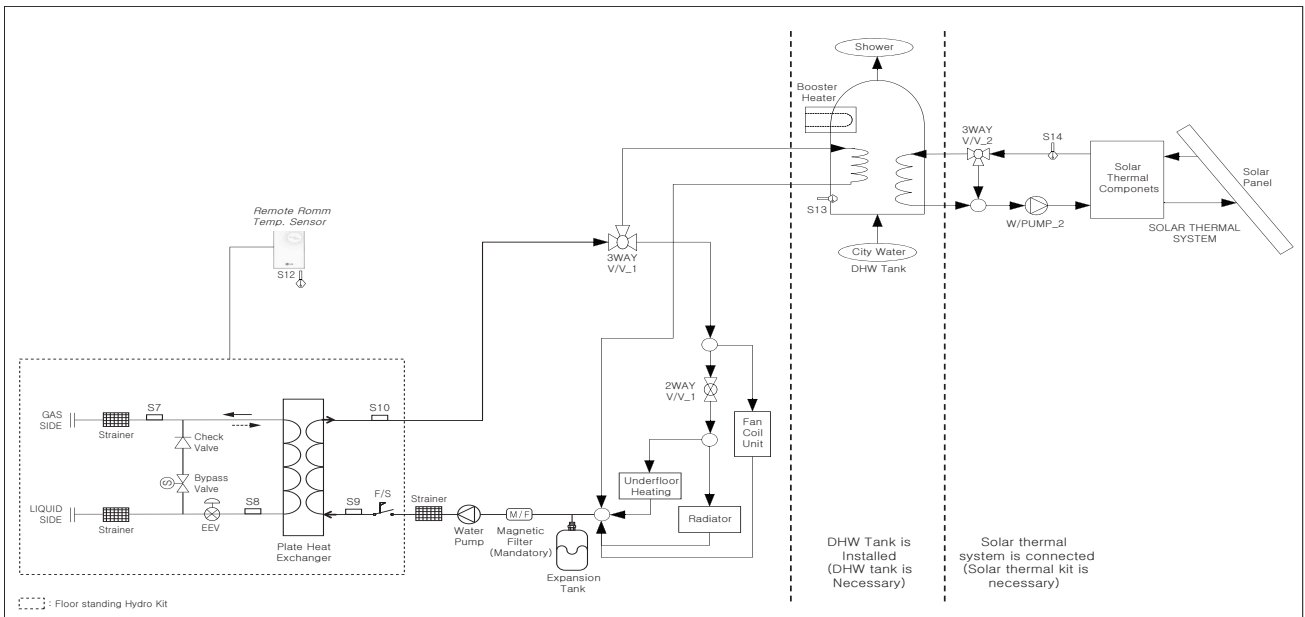

### Note

The schematic diagram above is given for reference only.

Actual schematic diagram may be different depending on the project requirement.

## 4. Piping diagrams

Category	Symbol	Meaning	PCB Connector	Remarks
Indoor Unit	S7	Refrigerant temperature sensor (Gas side)	CN_PIPE/OUT	- Meaning is expressed based on Cooling mode.
	S8	Refrigerant temperature sensor (Liquid side)	CN_PIPE/IN	
	S9	Entering Water temperature sensor	CN_TH3 (WATER IN) (PHEX OUT) (WATER OUT)	- S9, S10 are connected at 6 pin type connector CN_TH3.
	S10	Leaving Water temperature sensor		
	F/S	Flow Switch	CN_FLOW1	- To monitor water flow in the system.
	S12	Remote Air sensor (Room 1/Direct circuit)	CN_ROOM	- Optional accessory (sold separately)
	CTR/PNL	Control Panel (or 'Remote Controller')	CN_REMO	- Pre built-in at indoor unit
Space Heating/ Cooling	2WAYV/V_1	To block underfloor heating from cooling water	CN_2WAY_A	- 3rd party accessory and Field installation (sold separately) -2wire NO or NC type 2way valve is supported.
DHW Heating	DHW TANK	Water TANK	(no connector)	- Accessory and Field installation (sold separately) - Generating and storing DHW by Hydro kit or built-in backup heater
	Cold WATER	Water to be heated by Indoor unit and Booster Heater of W/TANK	(no connector)	- Field installation
	SHOWER	Water supplied to end-user	(no connector)	- Field installation
	S13	W/TANK water temperature sensor	CN_TH4	- S13 and S15 are connected at 4 pin type connector CN_TH4. - S13 is a part of DHW tank kit. - S14 is a part of solar thermal kit
S14	Solar-heated water temperature sensor			
Solar Heating	3WAYV/V_2	- Flow control for water which is heated and circulated by SOLAR THERMAL SYSTEM. - Flow direction switching between SOLAR THERMAL SYSTEM and W/TANK	CN_3WAY_B	- 3rd party accessory and Field installation (sold separately) - SPDT type 3way valve is supported.
	W_PUMP/2	External Water Pump	CN_W/PUMP_B	- 3rd party accessory and Field installation (sold separately) - If water pump of SOLAR THERMAL SYSTEM is incapable of circulation, external water pump can be used.
	SOLAR THERMAL SYSTEM	- This system can include following components : Solar panel, Sensors, Thermostats, Interim heat exchanger, Water pump, etc. - To utilized hot water heated by SOLAR THERMAL SYSTEM, end-user must install Solar-Kit accessory provided by LG.	(no connector)	- 3rd party accessory and Field installation (sold separately)
	Expansion Tank	Expansion Tank	(no connector)	- Absorb volume change of heated water,
Common	M / F	Magnetic Filter	(no connector)	- 3rd party accessory and Field installation (sold separately)
	3WAYV/V_1	- Flow control for water which is leaving from indoor unit. - Flow direction switching between underfloor and water tank	CN_3WAY_A	- 3rd party accessory and Field installation (sold separately) - SPDT type 3way valve is supported.
	Water Pump	Water Pump	Pump(A)	-Sold separately
	Strainer	Strainer	(no connector)	-Included in the product package

# 5. Wiring diagrams

## ARNH04GK2A4 / ARNH10GK2A4

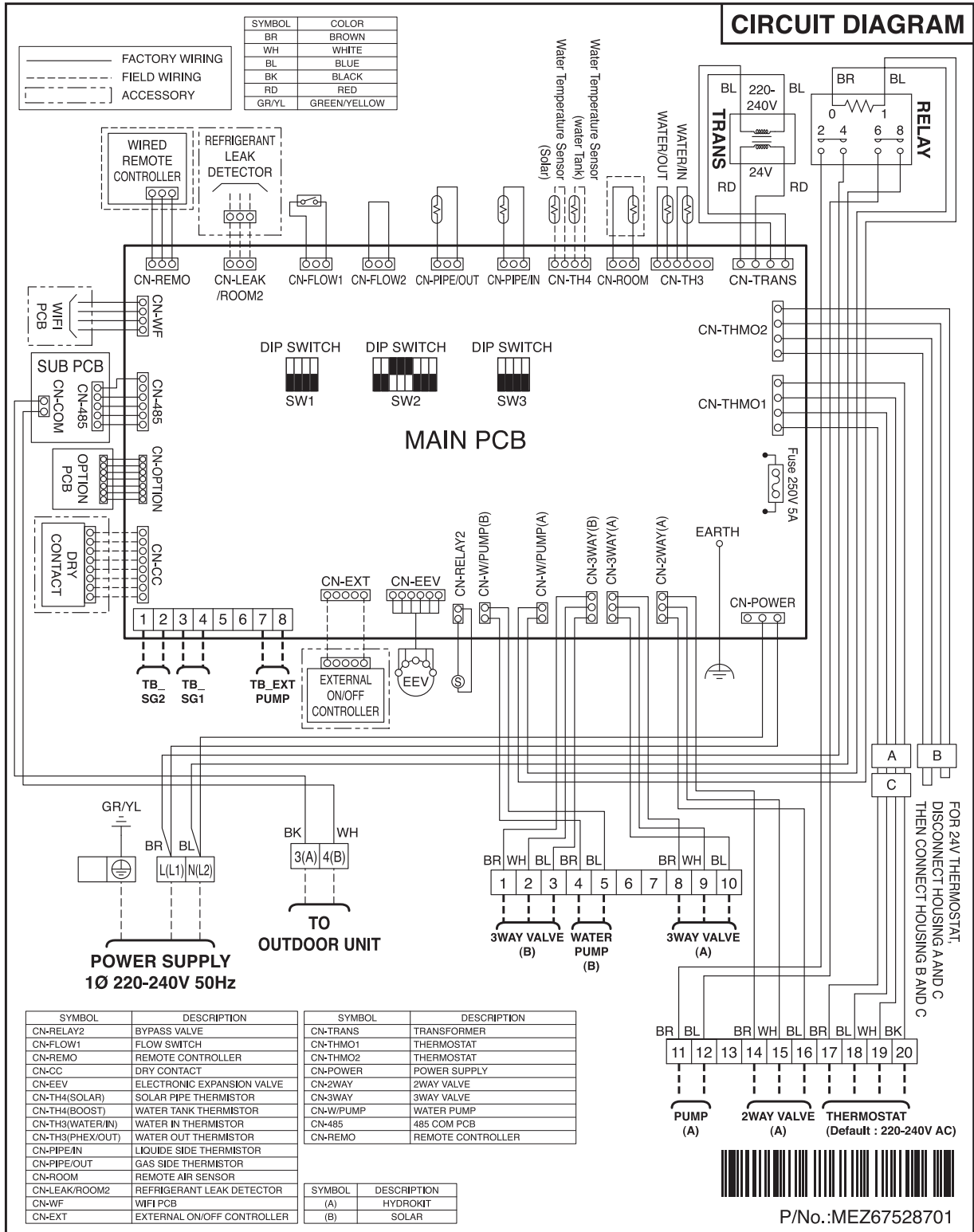

## 6. Capacity correction factor

### 6.1 Capacity correction factor by temperature

#### ■ Capacity/Power Input Calculation method

**Total Capacity = Hydro Kit Capacity + Indoor Unit Capacity**

$$\text{Hydro Kit Capacity} = Q_{\text{ODU}} \times (I_{\text{HK}} / I_{\text{TOTAL}}) \times F_{\text{TC,T\_HK}} \times F_{\text{TC,W\_HK}} \times F_{\text{TC,P\_ODU}} \times F_{\text{TC,D\_ODU}}$$

$Q_{\text{ODU}}$  = Outdoor Unit capacity by outdoor air (outside inlet water) temp. and capacity ratio at standard indoor temp. .... Refer to [Capacity tables of outdoor unit PDB](#)

\* Standard indoor temperature is 27/19°C DB/WB on cooling mode, 20°C DB on heating mode.

$F_{\text{TC,T\_HK}}$  = Capacity correction factor by Outdoor and water inlet temperature. .... Refer to [following Graph of this PDB](#)

$F_{\text{TC,W\_HK}}$  = Capacity correction factor by Water flow rate. .... Refer to [following Graph of this PDB](#)

$F_{\text{TC,P\_ODU}}$  = Capacity correction factor by Refrigerant Piping length. .... Refer to [correction factors of outdoor unit PDB](#)

$F_{\text{TC,D\_ODU}}$  = Capacity correction factor by Defrosting operation. .... Refer to [correction factors of outdoor unit PDB](#)

$I_{\text{HK}}$  = Capacity index for Hydro Kit .... Refer to [index table of this PDB](#)

$I_{\text{TOTAL}}$  = Sum of Capacity index for combined indoor units and hydro kit .... Refer to [index table of outdoor unit PDB](#)

**Total Power Input = Hydro Kit Power Input + Indoor Unit Power Input**

$$\text{Hydro Kit Power Input} = P_{\text{I\_ODU}} \times (I_{\text{HK}} / I_{\text{TOTAL}}) \times F_{\text{PI,T\_HK}} \times F_{\text{PI,W\_HK}}$$

$P_{\text{I\_ODU}}$  = Outdoor Unit Power Input by outdoor air (outside inlet water) temp. and capacity ratio at standard indoor temp. .... Refer to [Capacity tables of outdoor unit PDB](#)

\* Standard indoor temperature is 27/19°C DB/WB on cooling mode, 20°C DB on heating mode.

$F_{\text{PI,T\_HK}}$  = Power Input correction factor [Outdoor Unit] by Outdoor and water inlet temperature. .... Refer to [following Graph of this PDB](#)

$F_{\text{PI,W\_HK}}$  = Power Input correction factor [Outdoor Unit] by Water flow rate .... Refer to [following Graph of this PDB](#)

$I_{\text{HK}}$  = Capacity index for Hydro Kit .... Refer to [index table of this PDB](#)

$I_{\text{TOTAL}}$  = Sum of Capacity index for combined indoor units and hydro kit .... Refer to [index table of outdoor unit PDB](#)

#### Note

- When calculating at upper or lower temperature than the range of Outdoor unit capacity table, use the same value with the boundary value of that. For example, when calculating Heating PI with capacity table of Outdoor unit at upper temperature than 15°CDB, use the same value of PI at 15°C DB.

## 6. Capacity correction factor

### ■ ARNH04GK2A4 / ARNH10GK2A4 (Cooling)

- Combination with Multi V 5 system (ARU-5) and Multi V S system (ARU-S\*0)

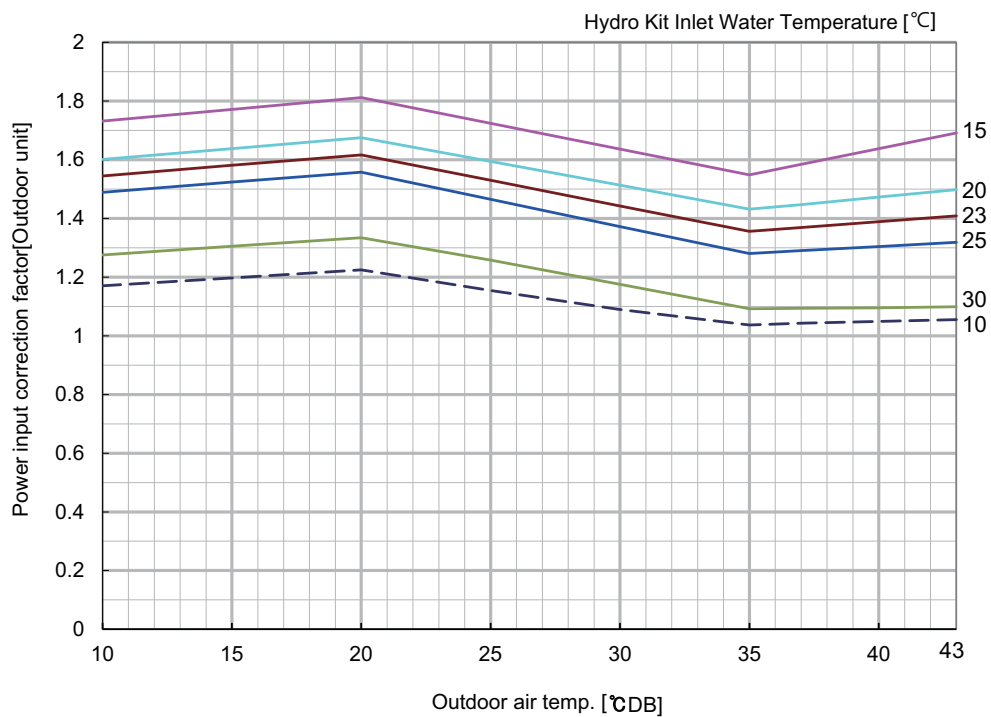
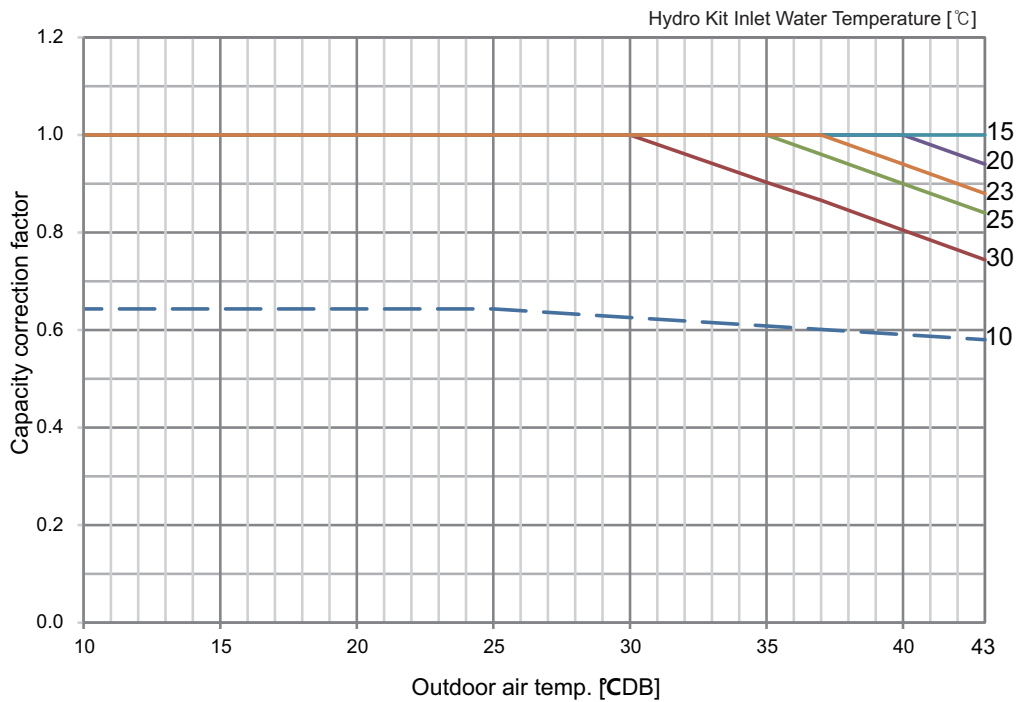

#### Note

- Correction factor follows the outdoor unit operation range and cannot operate outside the operating range.
- Leaving water temperature changes per pipe length of the system.  
Please check 'Minimum Leaving Water Temperature by Pipe Length' table in this PDB



## 6. Capacity correction factor

### ■ ARNH04GK2A4 / ARNH10GK2A4 (Cooling)

- Combination with Multi V Water system (ARW-)

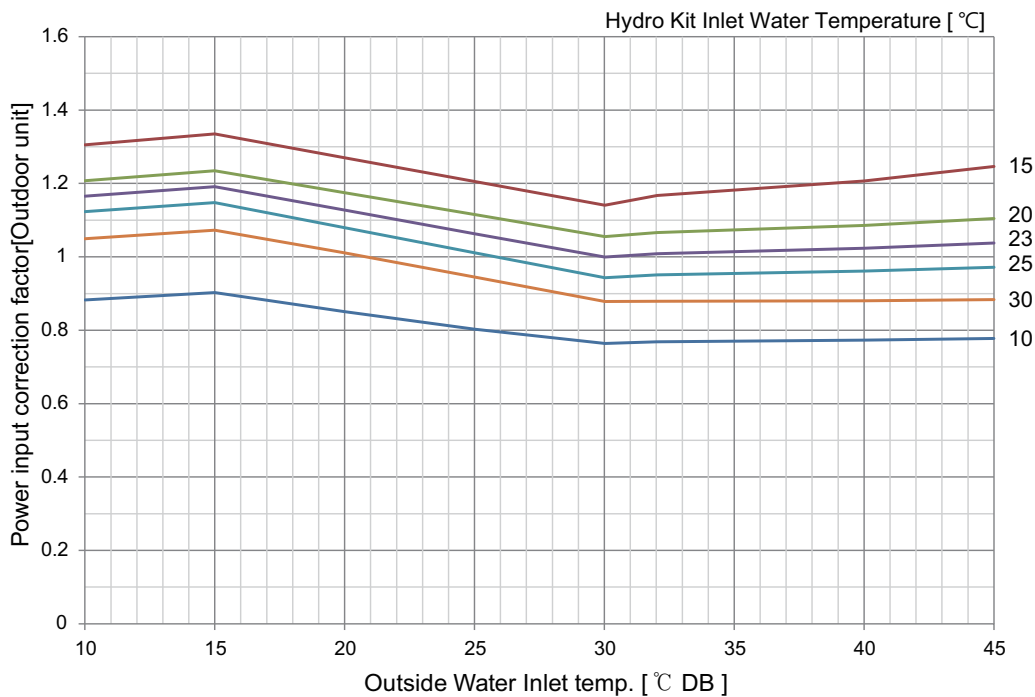
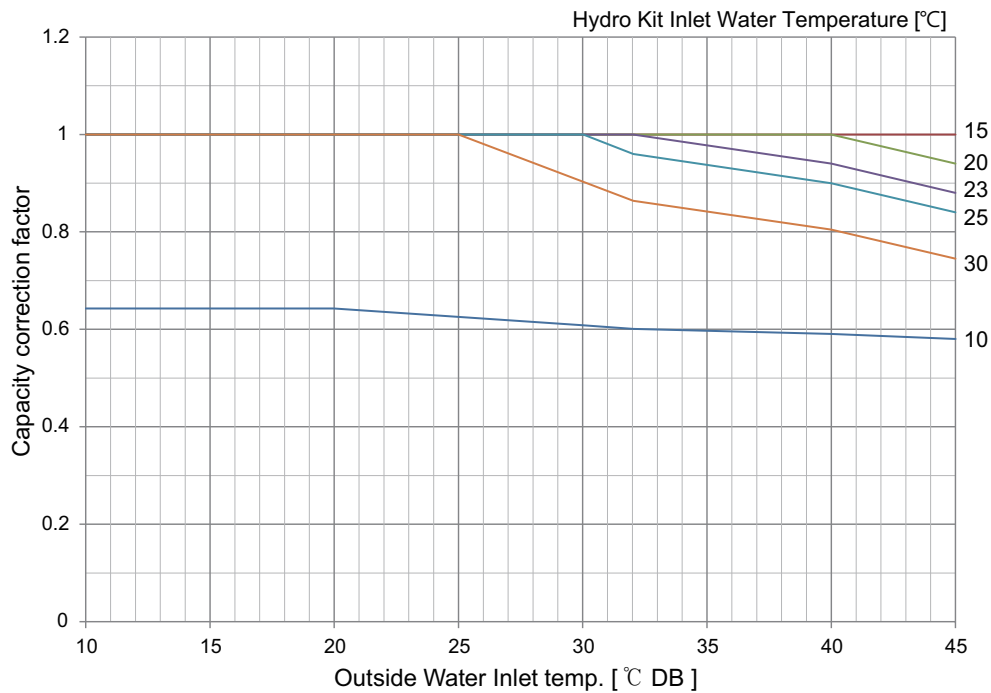

### Note

- Correction factor follows the outdoor unit operation range and cannot operate outside the operating range.
- Leaving water temperature changes per pipe length of the system.  
Please check 'Minimum Leaving Water Temperature by Pipe Length' table in this PDB

## 6. Capacity Correction Factor

### ■ ARNH04GK2A4 / ARNH10GK2A4 (Heating)

- Combination with Multi V 5 system (ARU-5) and Multi V S system (ARU-S\*0)

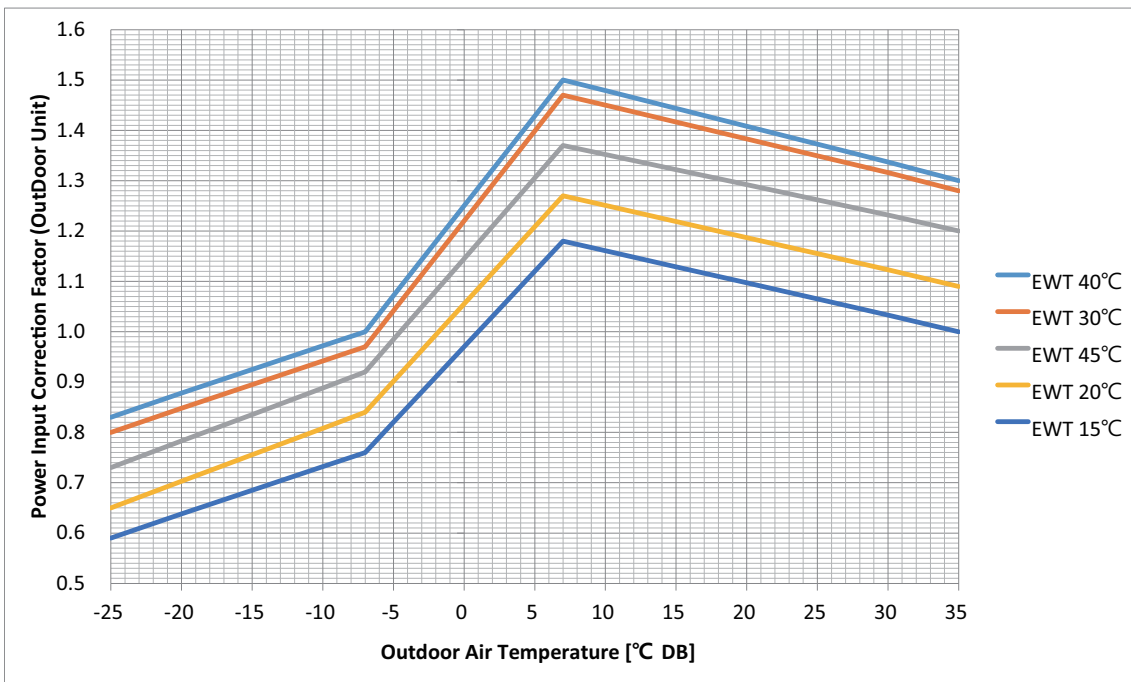
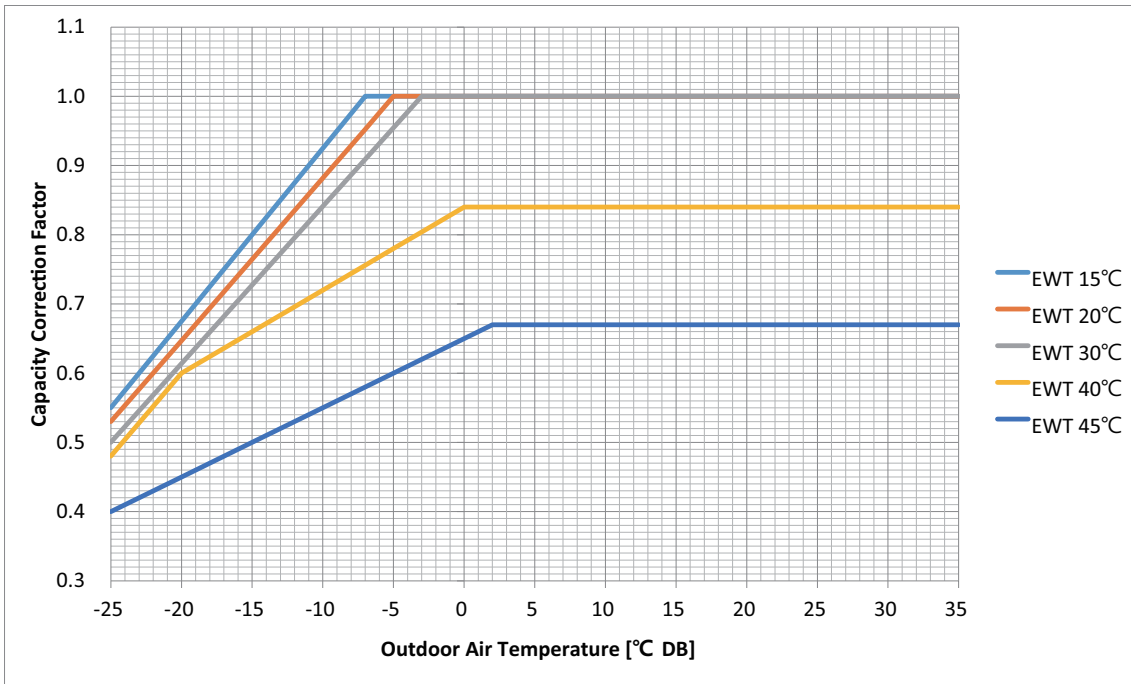

### Note

Correction factor follows the outdoor unit operation range and cannot operate outside the operating range.

## 6. Capacity correction factor

### ■ ARNH04GK2A4 / ARNH10GK2A4 (Heating)

- Combination with Multi V Water system (ARW-)

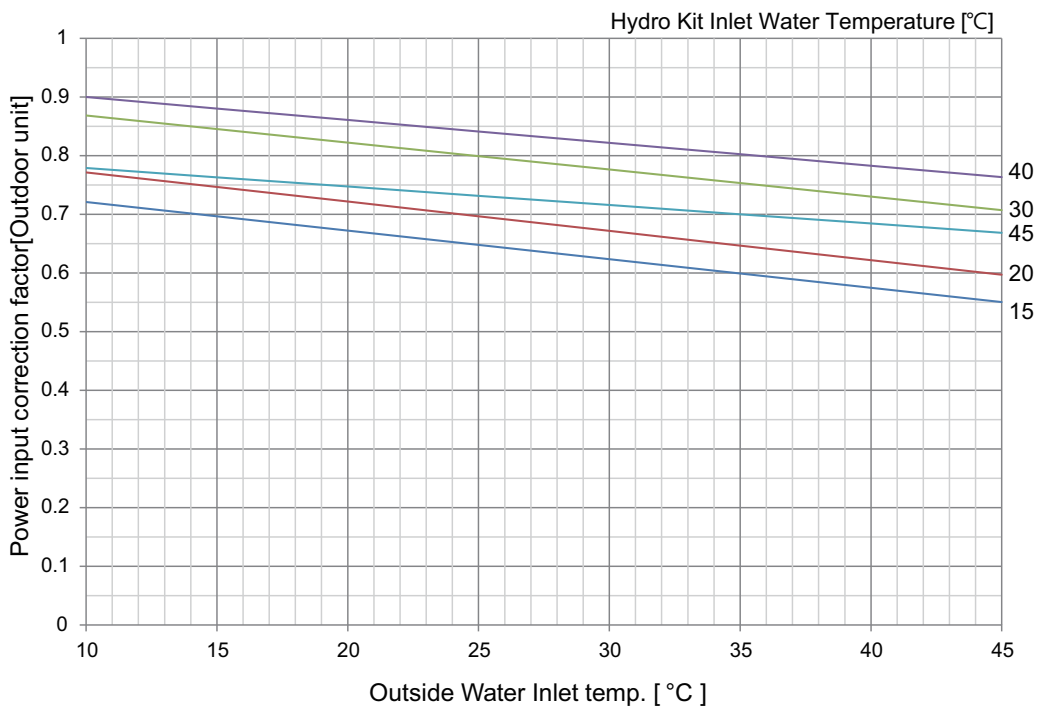
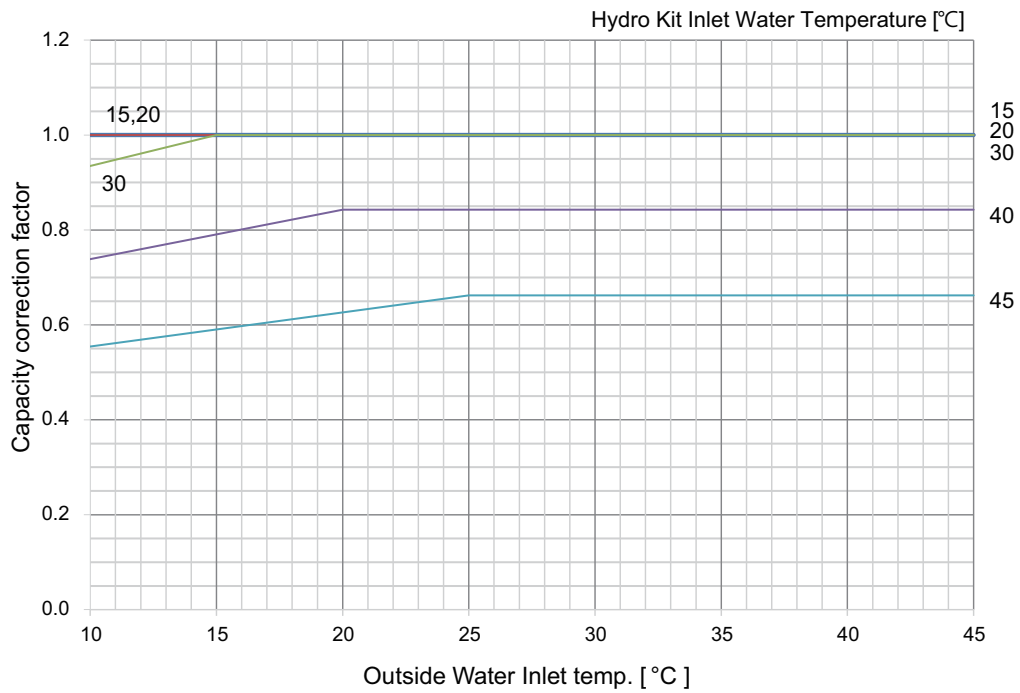

#### Note

Correction factor follows the outdoor unit operation range and cannot operate outside the operating range.

## 6. Capacity correction factor

### 6.2 Capacity correction factor by water flow rate

■ ARNH04GK2A4 (Cooling)

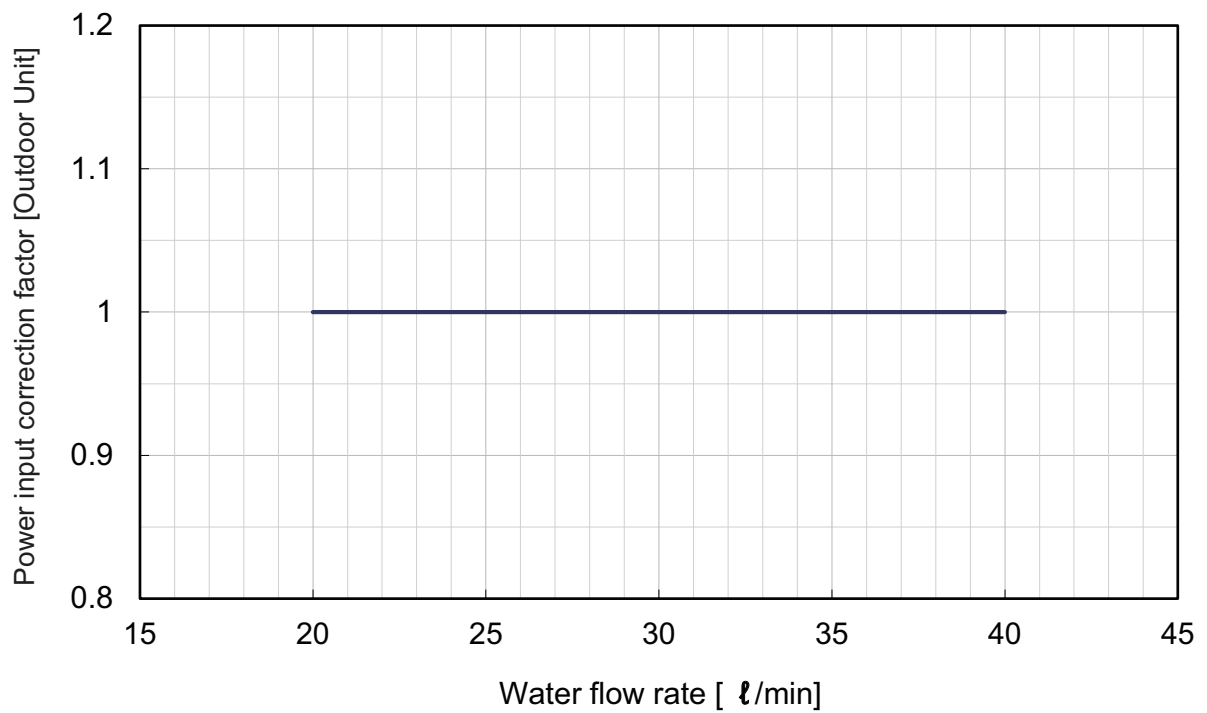
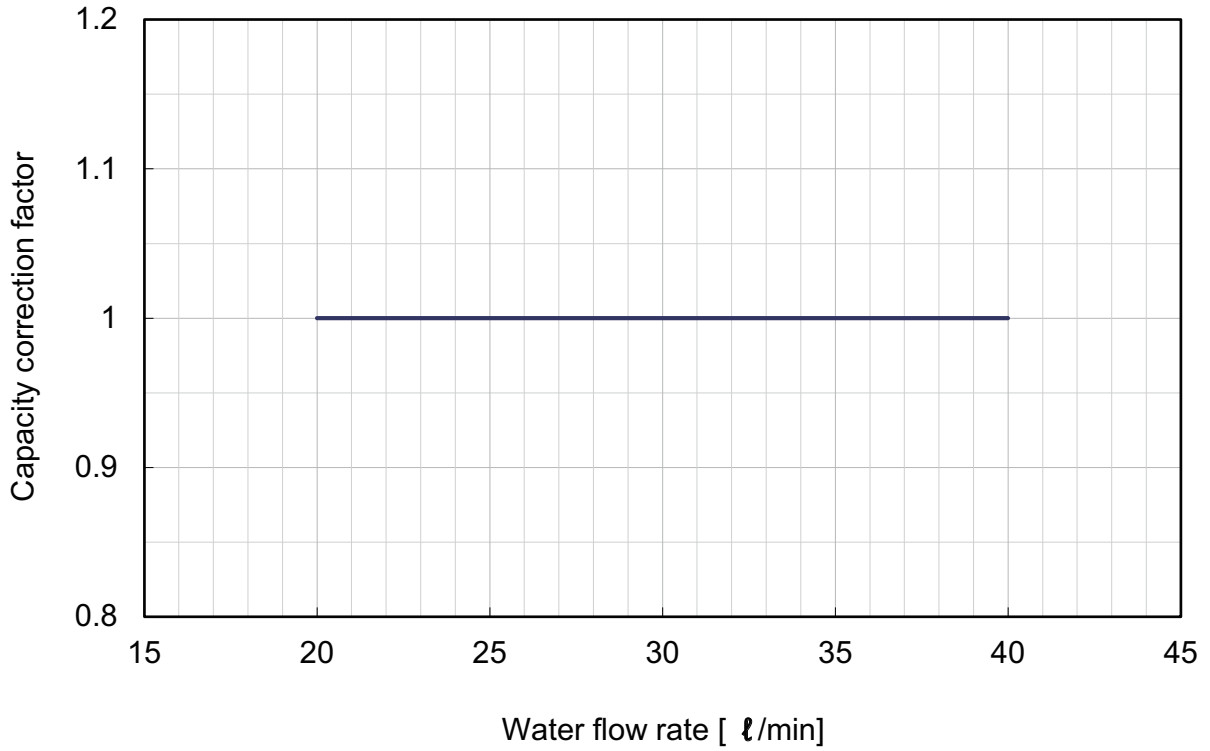

**⚠ WARNING**

Water Flow Rate Range (recommended) : ARNH04GK2A4 20 ~ 40 (ℓ/min)

## 6. Capacity correction factor

### ■ ARNH04GK2A4 (Heating)

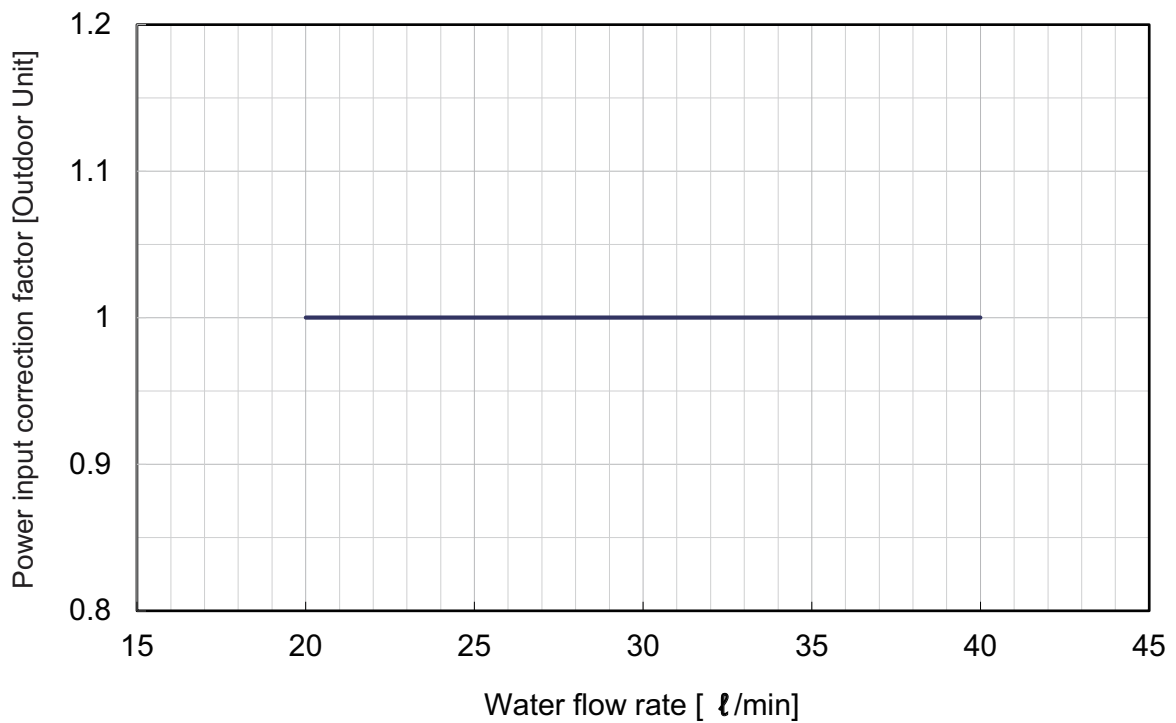
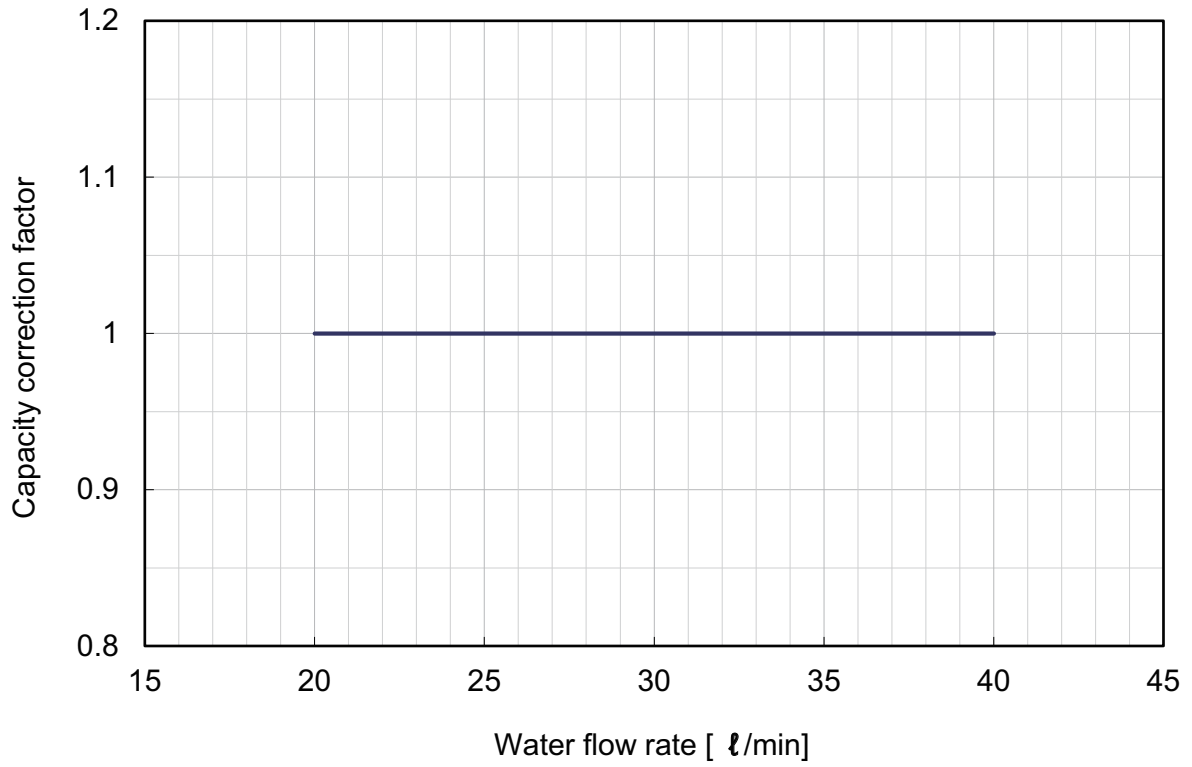

### **⚠ WARNING**

Water Flow Rate Range (recommended) : ARNH04GK2A4 20 ~ 40 (l/min)

## 6. Capacity correction factor

### ■ ARNH10GK2A4 (Cooling)

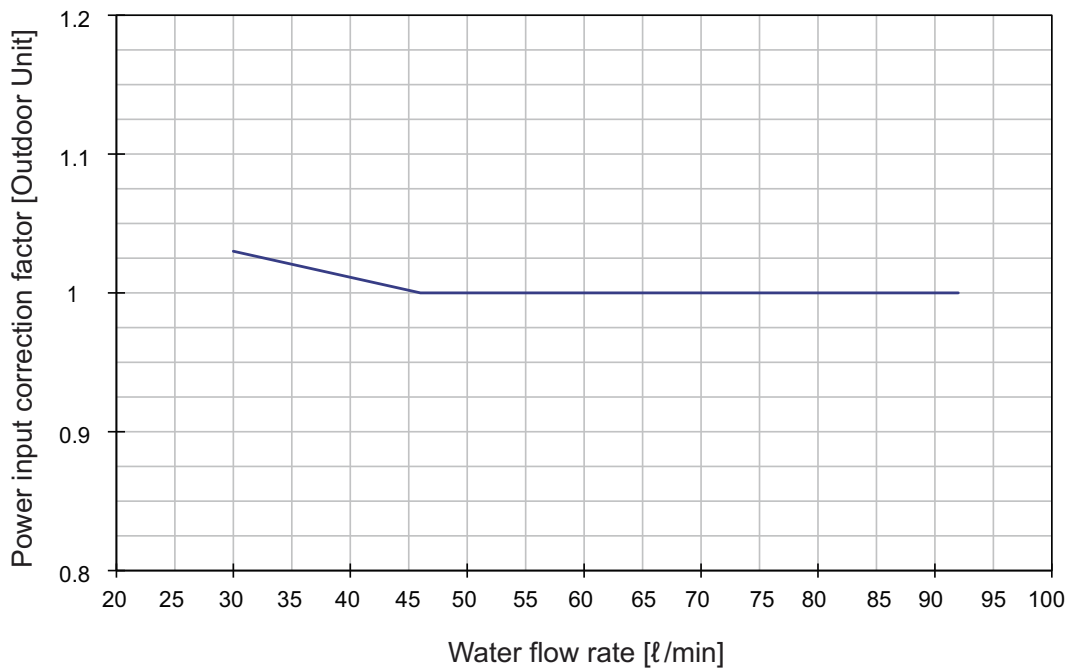
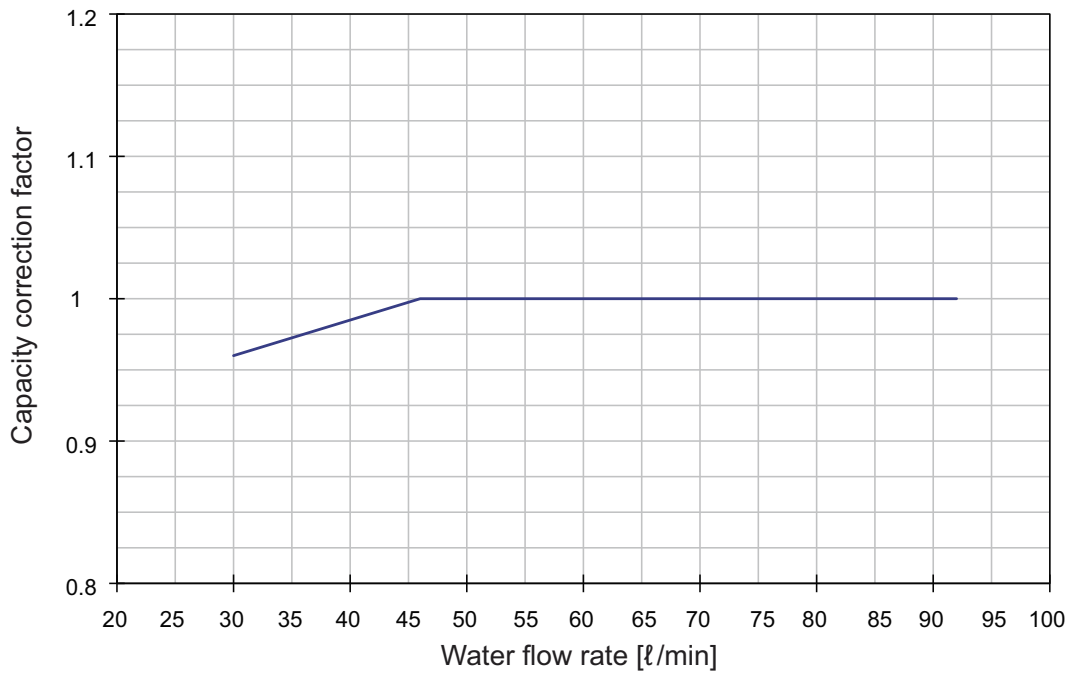

**⚠ WARNING**

Water Flow Rate Range (recommended) : ARNH10GK2A4 45 ~ 92 (ℓ/min)

## 6. Capacity correction factor

### ■ ARNH10GK2A4 (Heating)

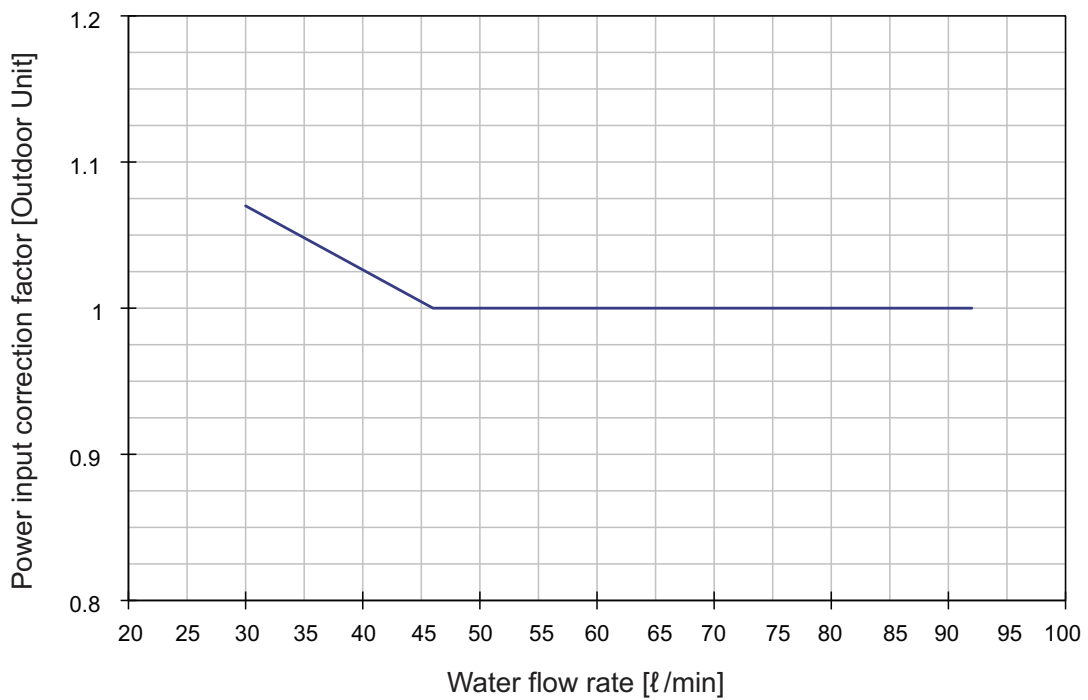
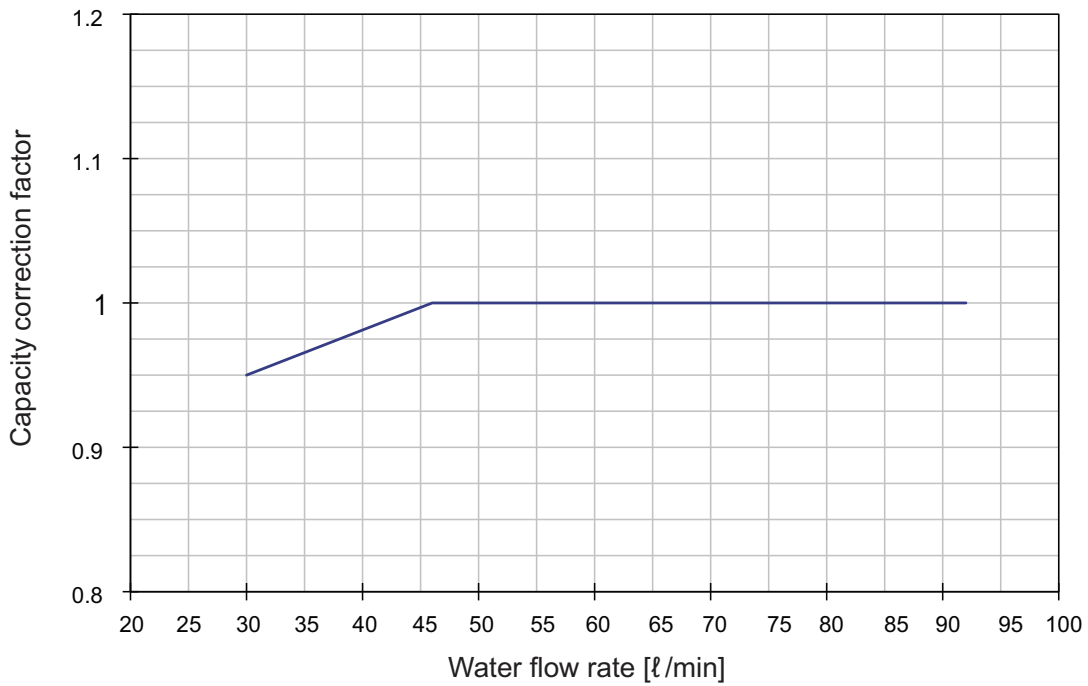

### **⚠ WARNING**

Water Flow Rate Range (recommended) : ARNH10GK2A4 45 ~ 92 (l/min)

## 6. Capacity correction factor

### 6.3 Capacity correction factor by antifreeze

Antifreeze Type	Item	Antifreeze % by wt				
		10%	20%	30%	40%	50%
Methanol	Cooling	0.998	0.997	0.995	0.993	0.992
	Heating	0.995	0.990	0.985	0.979	0.974
	Pressure Drop	1.023	1.057	1.091	1.122	1.160
Ethylene glycol	Cooling	0.996	0.991	0.987	0.983	0.979
	Heating	0.993	0.985	0.977	0.969	0.961
	Pressure Drop	1.024	1.068	1.124	1.188	1.263
Propylene glycol	Cooling	0.993	0.987	0.980	0.974	0.968
	Heating	0.966	0.973	0.960	0.948	0.935
	Pressure Drop	1.040	1.098	1.174	1.273	1.405

#### ◆ Correction factor of cooling capacity

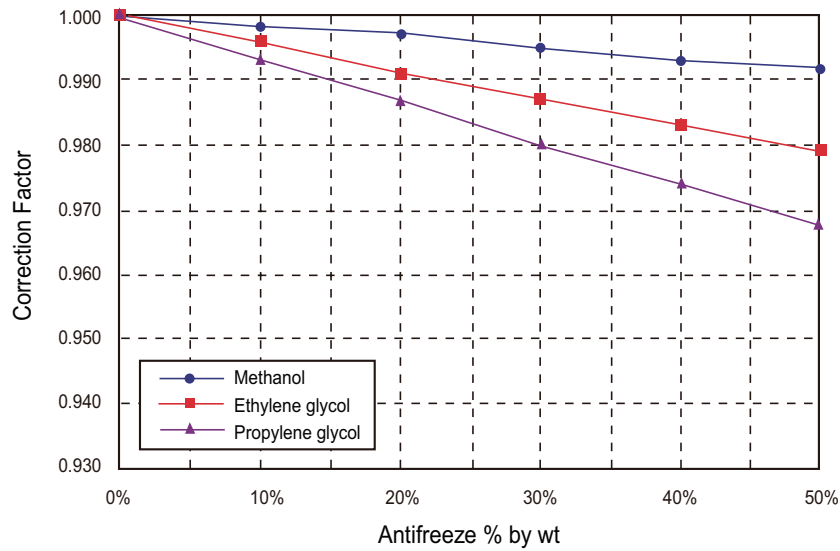

#### ◆ Correction factor of heating capacity

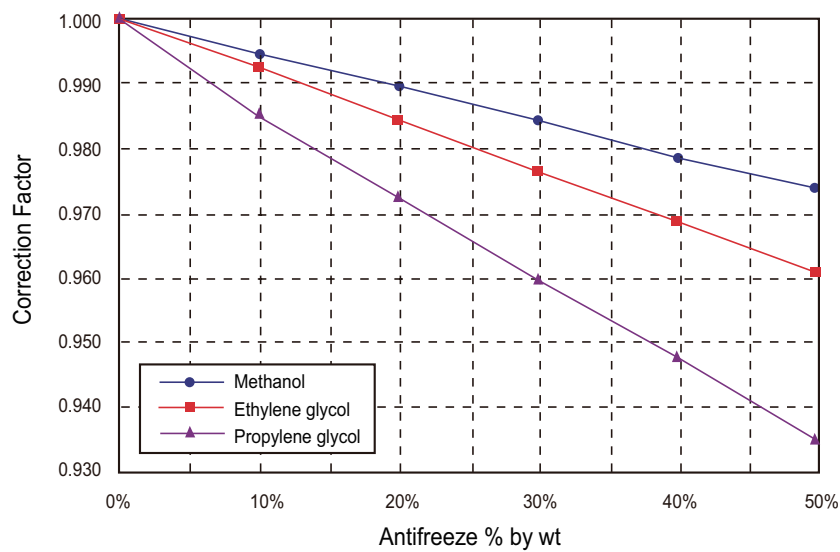

#### ⚠ CAUTION

Please apply antifreeze according to local regulation.



## 6. Capacity correction factor

### 6.4 Minimum Leaving Temperature by Piping Length

◆ For Cooling Operation

HU (m)	110	-	-	-	-	-	-	-	-	-	-	-	129	131	134	136	138	141	143	146	148	151	153	155	157			
	100	-	-	-	-	-	-	-	-	-	-	-	125	128	131	133	135	138	140	143	145	148	150	153	155	156		
	90	-	-	-	-	-	-	-	-	-	-	-	120	125	128	130	133	135	138	140	143	145	148	150	152	155	156	
	80	-	-	-	-	-	-	-	-	-	-	-	114	119	124	127	130	132	135	137	140	142	145	147	150	152	155	156
	70	-	-	-	-	-	-	-	-	-	109	114	119	124	127	129	132	134	137	139	142	144	147	149	152	154	156	
	60	-	-	-	-	-	-	-	103	108	113	118	123	126	128	131	134	136	139	141	144	147	149	152	154	155		
	50	-	-	-	-	-	97	102	107	112	117	122	125	128	131	133	136	139	141	144	146	149	151	154	155			
	40	-	-	-	-	91	97	102	107	112	117	122	125	127	130	133	135	138	141	143	146	149	151	154	155			
	30	-	-	-	86	91	96	101	106	111	116	121	124	127	130	132	135	138	140	143	146	148	151	153	155			
	20	-	-	80	85	90	95	100	106	111	116	121	124	126	129	132	135	137	140	143	145	148	151	153	154			
	10	-	74	79	84	89	95	100	105	110	115	120	123	126	129	131	134	137	140	142	145	148	150	153	154			
0	70	73	79	84	89	95	100	105	110	115	120	123	126	129	131	134	137	140	142	145	148	150	153	154				
Equivalent Length (m)	75	10	20	30	40	50	60	70	80	90	100	110	120	130	140	150	160	170	180	190	200	210	220	225				
	0	70	73	78	84	89	94	99	104	109	114	119	122	125	128	131	134	137	139	142	145	147	150	153	154			
	75	70	73	78	83	88	94	99	104	109	114	119	122	125	128	131	133	136	139	142	144	147	150	152	154			
	10	-	73	78	83	88	94	99	104	109	114	119	122	125	128	131	133	136	139	142	144	147	150	152	154			
	20	-	-	78	83	88	93	98	103	108	113	118	121	124	127	130	133	136	139	141	144	147	149	152	153			
	30	-	-	-	82	87	92	98	103	108	113	118	121	124	127	130	133	135	138	141	144	146	149	152	153			
	40	-	-	-	-	87	92	97	102	107	112	117	120	123	126	129	132	135	138	141	143	146	149	151	153			
	50	-	-	-	-	-	91	97	102	107	112	117	120	123	126	129	132	135	137	140	143	146	149	151	153			
	60	-	-	-	-	-	-	96	101	106	111	116	119	122	125	128	131	134	137	140	143	146	148	151	152			
	70	-	-	-	-	-	-	-	100	106	111	116	118	121	125	128	131	134	137	140	142	145	148	151	152			
	80	-	-	-	-	-	-	-	-	105	110	115	118	121	124	127	130	133	136	139	142	145	148	150	152			
90	-	-	-	-	-	-	-	-	-	109	114	117	120	124	127	130	133	136	139	142	145	147	150	151				
100	-	-	-	-	-	-	-	-	-	-	114	117	120	123	126	130	133	136	139	141	144	147	150	151				
110	-	-	-	-	-	-	-	-	-	-	-	116	119	123	126	129	132	135	138	141	144	147	150	151				

**Note**

Maximum height and pipe length may vary per outdoor unit.

For each piping limit, please check 'Refrigerant Piping System' section from the outdoor unit PDB.

## 7. Water pressure drop

### ■ ARNH04GK2A4

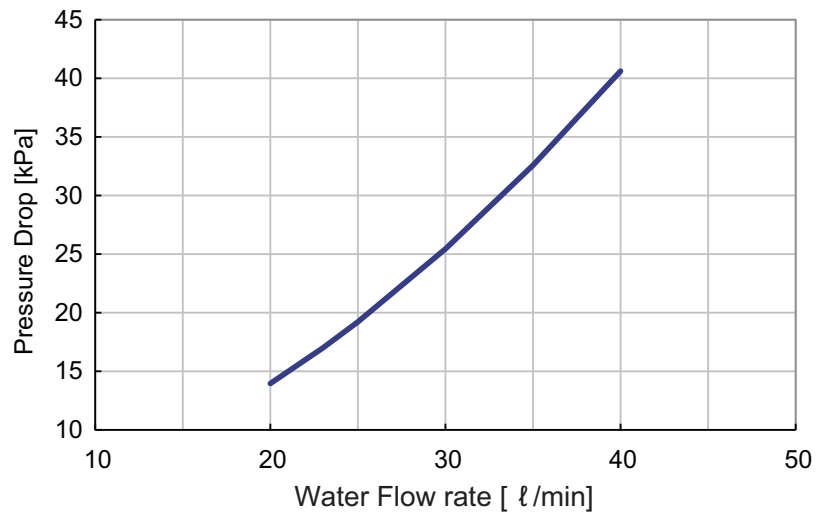

#### ⚠ CAUTION

Water Flow Rate Range (recommended) : ARNH04GK2A4 20 ~ 40 (ℓ/min)

### ■ ARNH10GK2A4

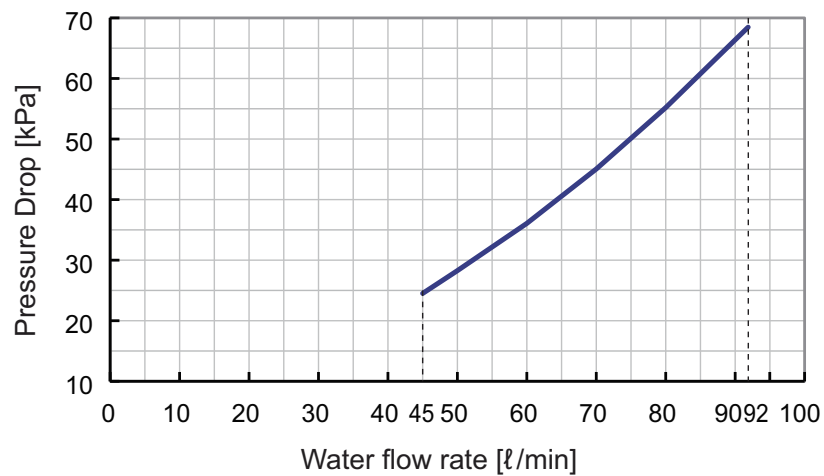

#### ⚠ CAUTION

Water Flow Rate Range (recommended) : ARNH10GK2A4 45 ~ 92 (ℓ/min)

#### Note

- The Flow Factor (Kv) is used for water devices without integrated pumps.
- Flow Factor is calculated using metric units :  $Kv = Q \times (SG / \Delta P)^{1/2}$ 
  - Q : Rated Water Flow (m<sup>3</sup>/hr)
  - ΔP : Head loss (bar)
  - SG is the specific gravity of the fluid (for water = 1)

## 8. Operation limits

### ■ Cooling

#### ◆ -RUM-----5,6(Heat Pump), ARUN-----5, ARUN-----0

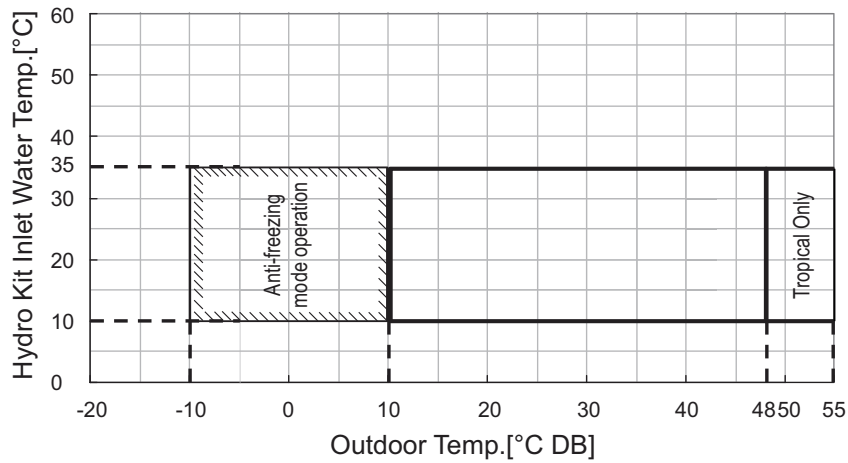

#### ◆ -RUM-----5,6 (Heat Recovery), ARUB-----0(Heat Recovery)

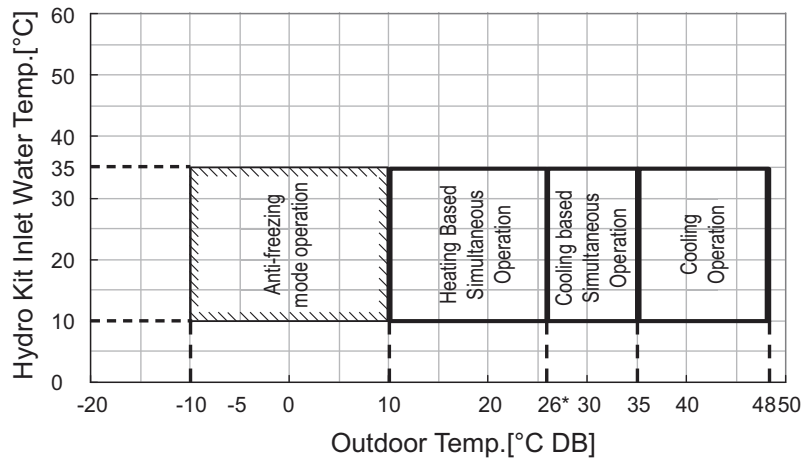

#### ◆ ARWN-series, ARWB-series

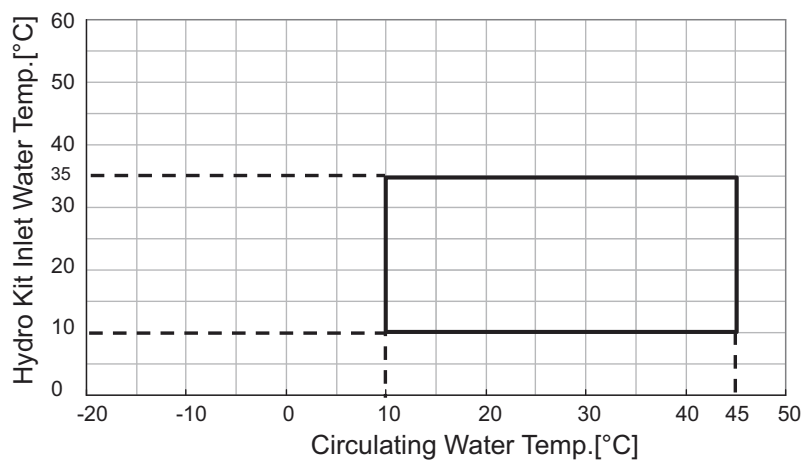

### Note

1. Operation limit follows the outdoor unit operation range and cannot operate outside the operating range. Also operation limit depends on product type and target region.
2. 'Simultaneous Operation' means other Indoor units are operating on heating mode.
3. \* : 26°C DB corresponds to the 16°C WB .

## 8. Operation limits

### ■ Heating

#### ◆ -RUM-----5,6(Heat Pump), ARUN-----5, ARUN-----0

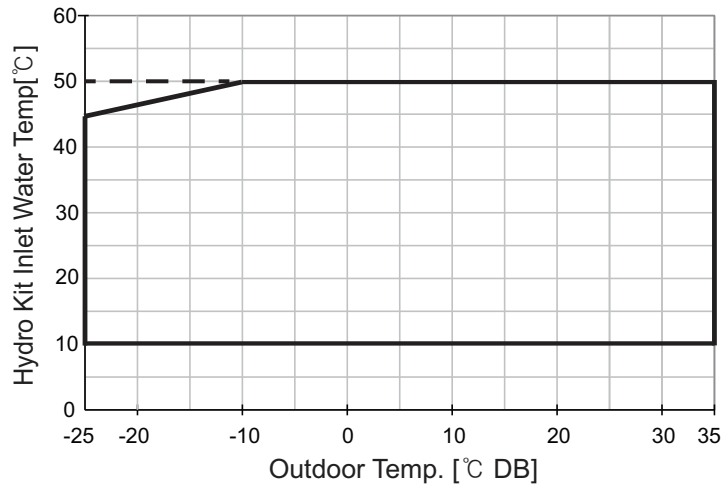

#### ◆ -RUM-----5,6 (Heat Recovery), ARUB-----0(Heat Recovery)

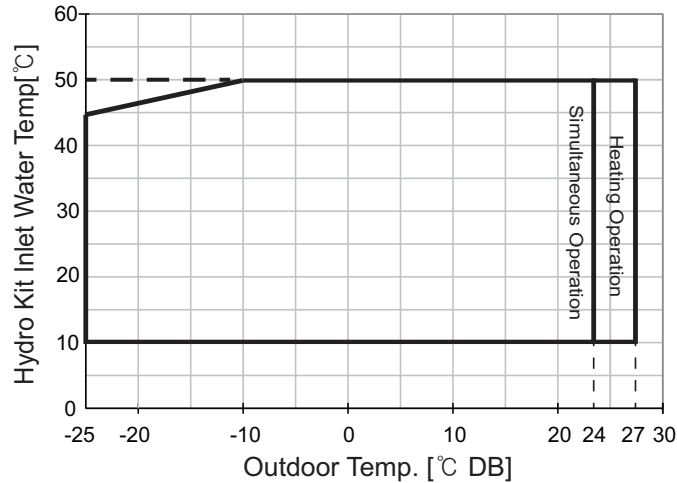

#### ◆ ARWB- series, ARWN-series

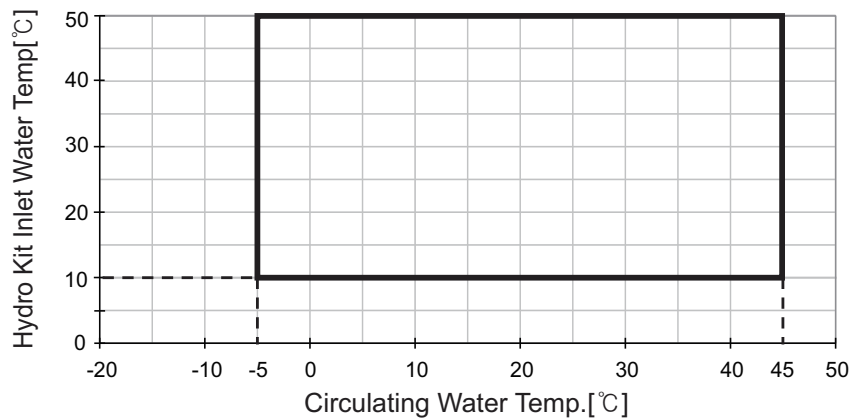

### Note

1. For only Hydro Kit combination, Maximum operation limit in heating is outdoor temperature 35°C DB / 24°C WB.
2. Operation limit follows the outdoor unit operation range and cannot operate outside the operating range. Also operation limit depends on product type and target region.
3. 'Simultaneous Operation' means other Indoor units are operating on cooling mode.

## 9. Electric characteristics

### ■ Wiring of Main Power Supply and Equipment Capacity

1. The power supply work is needed only to the outdoor unit. The power supply to the indoor unit or the BD unit is conducted through the transmission wiring. Therefore, the power supply work can be carried out at just one place of the outdoor unit. It will contribute to simplify the work procedure and to save cost.
2. Bear in mind ambient conditions (ambient temperature, direct sunlight, rain liquid, etc.) when proceeding with the wiring and connections
3. The wire size is the minimum value for metal conduit wiring. The power cord size should be 1 rank thicker taking into account the line voltage drops. Make sure the power-supply voltage does not drop more than 10%.
4. Specific wiring requirements should adhere to the wiring regulations of the region.
5. Power supply cords of parts of appliances for outdoor use should not be lighter than polychloroprene sheathed flexible cord.
6. Don't install an individual switch or electrical outlet to disconnect each of indoor unit separately from the power supply.

### WARNING

- Follow ordinance of your governmental organization for technical standard related to electrical equipment, wiring regulations and guidance of each electric power company.
- Make sure to use specified wires for connections so that no external force is imparted to terminal connections. If connections are not fixed firmly, it may cause heating or fire.
- Make sure to use the appropriate type of overcurrent protection switch. Note that generated overcurrent may include some amount of direct current.

### CAUTION

- All installation site must require attachment of an earth leakage breaker. If no earth leakage breaker is installed, it may cause an electric shock.
- Do not use anything other than breaker and fuse with correct capacity. Using fuse and wire or copper wire with too large capacity may cause a malfunction of unit or fire.

Model	Type	Hz	Volts	Voltage Range	Power Supply			Input(W)	
					MCA(A)	MFA(A)	FLA(A)	Cooling(W)	Heating(W)
ARNH04GK2A4 ARNH10GK2A4	K2	50	220-240	Max:264 Min:198	0.06	15	0.05	10	10
	K2	60	220	Max:242 Min:198	0.06	15	0.05	10	10

### Symbols

**MCA** : Minimum Circuit Amperes (A)

**MFA** : Maximum Fuse Amperes (A)

**W** : Rated input (W)

**FLA** : Full Load Amperes (A)

### Note

1. Voltage range  
Units are suitable for use on electrical systems where voltage supplied to unit terminals is not below or above the listed range limits.
2. Maximum allowable voltage unbalance between phases is 2%.
3. MCA/MFA  
MCA=1.25 x FLA  
MFA ≤ 4 x FLA  
(Next lower standard fuse rating. Minimum 15A)
4. Select wire size based on the MCA
5. Instead of fuse, use Circuit Breaker.

# 10. Sound levels

## 10.1 Sound pressure level

### Overall

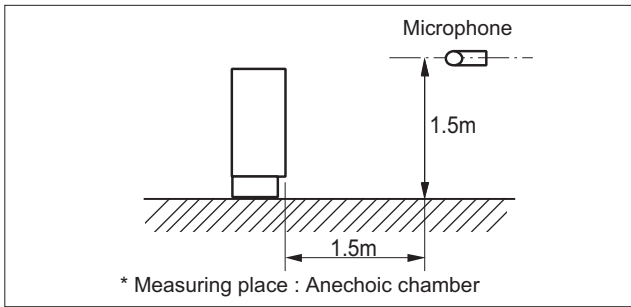

**Note**

1. Sound measured at some distance away from the center of the unit.
2. Data is valid at free field condition.
3. Reference acoustic pressure 0dB = 20μPa.
4. Data is valid at nominal operation condition. Refer to the Model Specifications for nominal conditions (Power source and Ambient temperature, etc)
5. Sound level will vary depending on a range of factors such as the construction (acoustic absorption coefficient) of particular room in which the equipment is installed.
6. Sound pressure level is measured on the rated condition in the anechoic rooms by ISO 3745 standard. Therefore, these values can be increased owing to ambient conditions during operation.

Model	Sound Level (dB(A))
ARNH04GK2A4	26
ARNH10GK2A4	

### ARNH04GK2A4 / ARNH10GK2A4

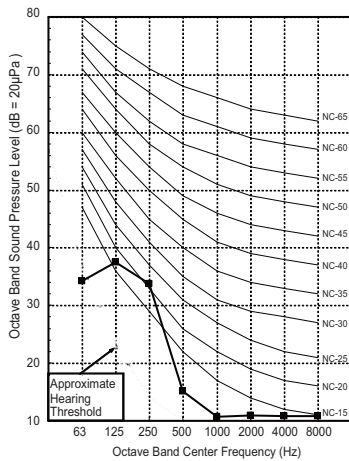

## **Floor Standing (High Temperature)**

- 1. List of functions**
- 2. Specifications**
- 3. Dimensions**
- 4. Piping diagrams**
- 5. Wiring diagrams**
- 6. Capacity correction factor**
- 7. Water pressure drop**
- 8. Operation limits**
- 9. Electric characteristics**
- 10. Sound levels**

# 1. List of functions

## Basic function of Units

Category	Functions	ARNH04GK3A4 / ARNH08GK3A4
Installation	Drain pump	X
	E.S.P. control	X
	Electric heater (operation)	X
	High ceiling operation	X
Reliability	Hot start	X
	Self diagnosis	O
	Soft dry operation	X
Convenience	Auto changeover	X
	Auto cleaning	X
	Auto operation (artificial intelligence)	X
	Auto restart operation	O
	Child lock	O
	Forced operation	X
	Group control	O
	Sleep mode	X
	Timer (on/off)	O
	Timer (weekly)	O
Individual control	Two thermistor control	X
	Standard wired remote controller	O
	Premium wired remote controller	X
	Simple wired remote controller	X
	Simple Wired remote controller(for hotel use)	X
Network function	Wireless remote controller(simple)	X
	General central controller (Non LGAP)	X
Hydro Kit Functions	Network Solution (LGAP)	O
	Anti-Condensation on floor (cooling)	X
	Water Pump ON / OFF Control	O
	Water Flow detection	O
	Thermostat Interface (230V AC)	O
	Thermostat Interface (24V AC)	X
	DHW(Domestic Hot Water) tank kit	X
	PHEX Anti-Freezing Control	O
	Water Pump Forced Operation	O
	Autosetting according to Ambient Temperature (for heating operation)	O
	Silent Operation	X
	Anti-overheating of Water Pipe	O
	Emergency Operation	O
	Weather Dependent Operation with Thermostat	X
	Scheduler (Domestic Hot Water Tank Heater)	X
	Timer (Domestic Hot Water Tank Heater)	X
	Quick Domestic Hot Water Tank Heating	O
	Electric Heater Capacity Control	X
	Screed Drying Mode	X
	Sump Heater	X
	One Point Dry Contact Input (CN-EXT)	O
	Tank Disinfection	O
	Pump Frequency	X
SG Ready	X	
ODU Cycle Priority (Heating Priority)	O	

### Note

1. O : Applied, X : Not applied

Accessory : Ordered and purchased separately the accessory package referring to the model name provided and install at field.

Accessory line-ups varies by region, so check your local catalogue or local sales material.



# 1. List of functions

## ■ Accessory Compatibility List

Category		Product	ETC	ARNH04GK3A4 ARNH08GK3A4
Central Controller	Simple	PQCSZ250S0	AC EZ	X
	AC Ez Touch	PACEZA000	AC Ez Touch	O
	AC Smart	PACS4B000	AC Smart IV	O
		PACS5A000	AC Smart 5	O
	ACP	PACP4B000	ACP IV	O
		PACP5A000	ACP 5	O
	AC Manager	PACM4B000	AC Manager IV	O
PACM5A000		AC Manager 5	O	
Gateway	BACnet	PQNFB17C0	ACP BACnet	O
	Lonworks	PLNWKB000	ACP Lonworks	O
	Modbus	PMBUSB00A	Modbus Gateway	O
Dry contact	Simple Contact	PDRYCB000	Simple Dry Contact	O
		PDRYCB100		
	Communication type	PDRYCB400	2 Points Dry Contact (For Setback)	X
		PDRYCB300	Dry Contact For 3rd Party Thermostat	O
	PDRYCB500	Dry Contact For Modbus	X	
ETC	Remote temperature sensor	PQRSTA0	-	O
	Zone controller	ABZCA	-	X
	Group control wire	PZCWRCG3	0.25m	O
	Wi-Fi Controller*	PWFMD200	-	O
	Multi-Tenant Power Module	PINPMB001	-	X
	Refrigerant Leakage Detector	PRLDNVS0	-	O
	PDI	PPWRDB000	PDI Standard	O
PQNUD1S40		PDI Premium	O	
Special Kit for Hydrokit	Solar-Thermal Interface kit with DHW Tank	PHLLA	Limit Temperature : 96 °C	X
	Indoor Drain Pan	PHDPB	-	X

### Note

1. O : Applied, X : Not applied

Accessory model name : Installed at field, ordered and purchased separately by the corresponding model name, supplied with separated package.

2. If you need more detail, please refer to the BECON PDB or the manual of product.

(<http://partner.lge.com/global> : Home > Doc.Library > Product > Control(BECON))

## 2. Specifications

Model		Unit	ARNH04GK3A4	ARNH08GK3A4	
Capacity (Rated)	Heating	kW	13.8	25.2	
		kcal/h	11,870	21,700	
		Btu/h	47,000	86,000	
Input (Rated)		Heating	kW	2.30	5.00
Casing		Material	-	Painted Steel Plate	Painted Steel Plate
		Color (RAL code)	-	RAL 7030	
Dimensions	Net	Body(W x H x D)	mm	520 x1,074 x 330	520 x1,074 x 330
			inch	20-15/32 x 42-9/32 x 13	20-15/32 x 42-9/32 x 13
Weight	Net	Body	kg (lbs)	86.0(189.6)	90.0(198.4)
Heat Exchanger	Refrigerant to Refrigerant	Type	-	Brazed Plate HEX	Brazed Plate HEX
		Quantity	EA	1	1
		Number of Plate	EA	50	60
	Refrigerant to Water	Type	-	Brazed Plate HEX	Brazed Plate HEX
		Quantity	EA	1	1
		Number of Plate	EA	76	48
		Rated Water Flow	l / min	19.8	36
		Head Loss	kPa	5	20
Compressor	Type	-	Twin Rotary inverter	Twin Rotary inverter	
	Piston Displacement	cm <sup>2</sup> /rev	52.5	52.5	
	Number of Revolution	rev/min	3,600	3,600	
	Motor Output x Number	W x No.	4,000 x 1	4,000 x 1	
	Starting Method	-	Direct On Line	Direct On Line	
	Oil Type	-	FVC68D(PVE)	FVC68D(PVE)	
	Oil Charge	cc	1,300	1,300	
Temperature Control		-	Microprocessor, Thermostat for heating		
Water Tank Temperature Sensor		Type(Sensor Holder)	inch	Male PT 1/2	
		Length	m	12	
Sound Absorbing Thermal Insulation Material		-	Foamed polystyrene		
Safety Device		-	Fuse, High Pressure Switch		
Piping Connections	Water Side	Inlet	inch	Male PT1	Male PT 1
		Outlet	inch	Male PT1	Male PT 1
	Refrigerant Side	Liquid	mm(inch)	Ø 9.52(3/8)	Ø 9.52(3/8)
		Gas	mm(inch)	Ø 15.88(5/8)	Ø 19.05(3/4)
Drain Piping Connection		-	inch	Male PT1	Male PT 1
Sound Pressure Level		Cooling	dB(A)	-	-
		Heating	dB(A)	44	46
Transmission cable		No. x mm <sup>2</sup>	2C x 1.0~1.5	2C x 1.0~1.5	
Refrigerant	Refrigerant to Refrigerant	Refrigerant name	-	R410A / R32	R410A / R32
		Additional Refrigerant Charge Amount	kg (lbs)	0.8 (1.8)	1.0 (2.2)
		Control	-	Electronic Expansion Valve	
	Refrigerant to Water	Refrigerant name	-	R134a	R134a
		Precharged Amount	kg (lbs)	2.3 (5.1)	3.0 (6.6)
		t-CO <sub>2</sub> eq	-	3.29	4.29
Power Supply		V, Ø, Hz	220-230-240, 1, 50/60	220-230-240, 1, 50/60	
Running Current		Heating	A	10.56 - 10.10 - 9.68	23.00 - 22.00 - 21.08

### Note

- Capacities are based on the following conditions:
  - Heating Temperature :Outdoor 7°C(44.6°F) DB / 6°C(42.8°F) WB, Water Inlet 55°C(131°F) / Outlet 65°C(149°F)
  - Difference Limit of Elevation (Outdoor ~ Indoor Unit) is 0m.
  - Piping Length : Interconnected Pipe Length = 7.5m
- Wiring cable size must comply with the applicable local and national code
- Due to our policy of innovation, some specifications may be changed without notification.
- Sound pressure level is measured on the rated condition in the anechoic rooms by ISO 3745 standard. Therefore, these values can be increased owing to ambient conditions during operation.
- This product contains Fluorinated greenhouse gases. (R410A,GWP(Global warming potential) = 2087.5)

### 3. Dimensions

■ ARNH04GK3A4

[Unit: mm]  
 Chassis : K3  
 TBJ37454401\_Rev.02

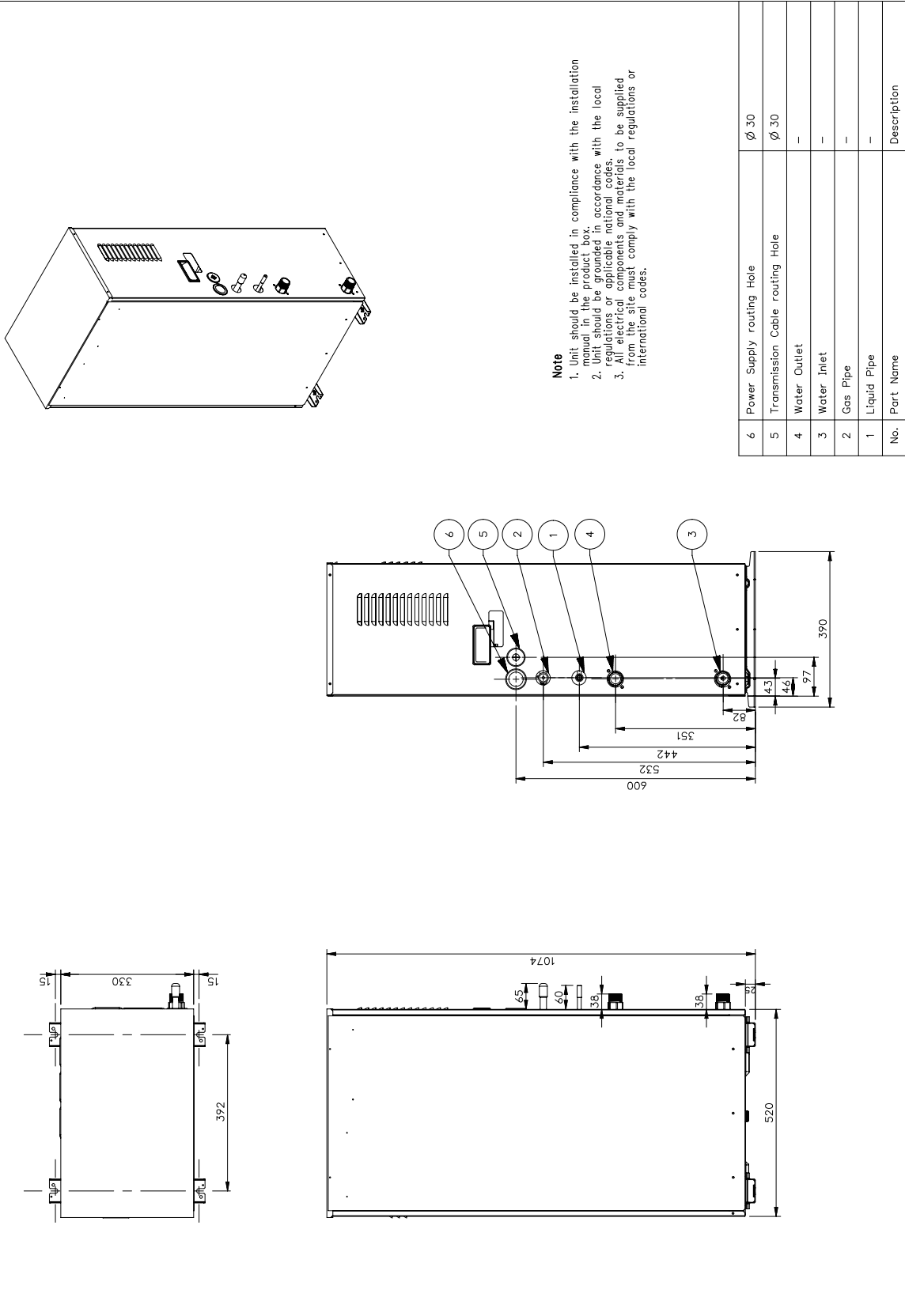

**Note**  
 1. Unit should be installed in compliance with the installation manual in the product box.  
 2. Unit should be installed in accordance with the local regulations or applicable national codes.  
 3. All electrical components and materials to be supplied from the site must comply with the local regulations or international codes.

No.	Part Name	Description
6	Power Supply routing Hole	∅ 30
5	Transmission Cable routing Hole	∅ 30
4	Water Outlet	-
3	Water Inlet	-
2	Gas Pipe	-
1	Liquid Pipe	-

# 3. Dimensions

## ■ ARNH08GK3A4

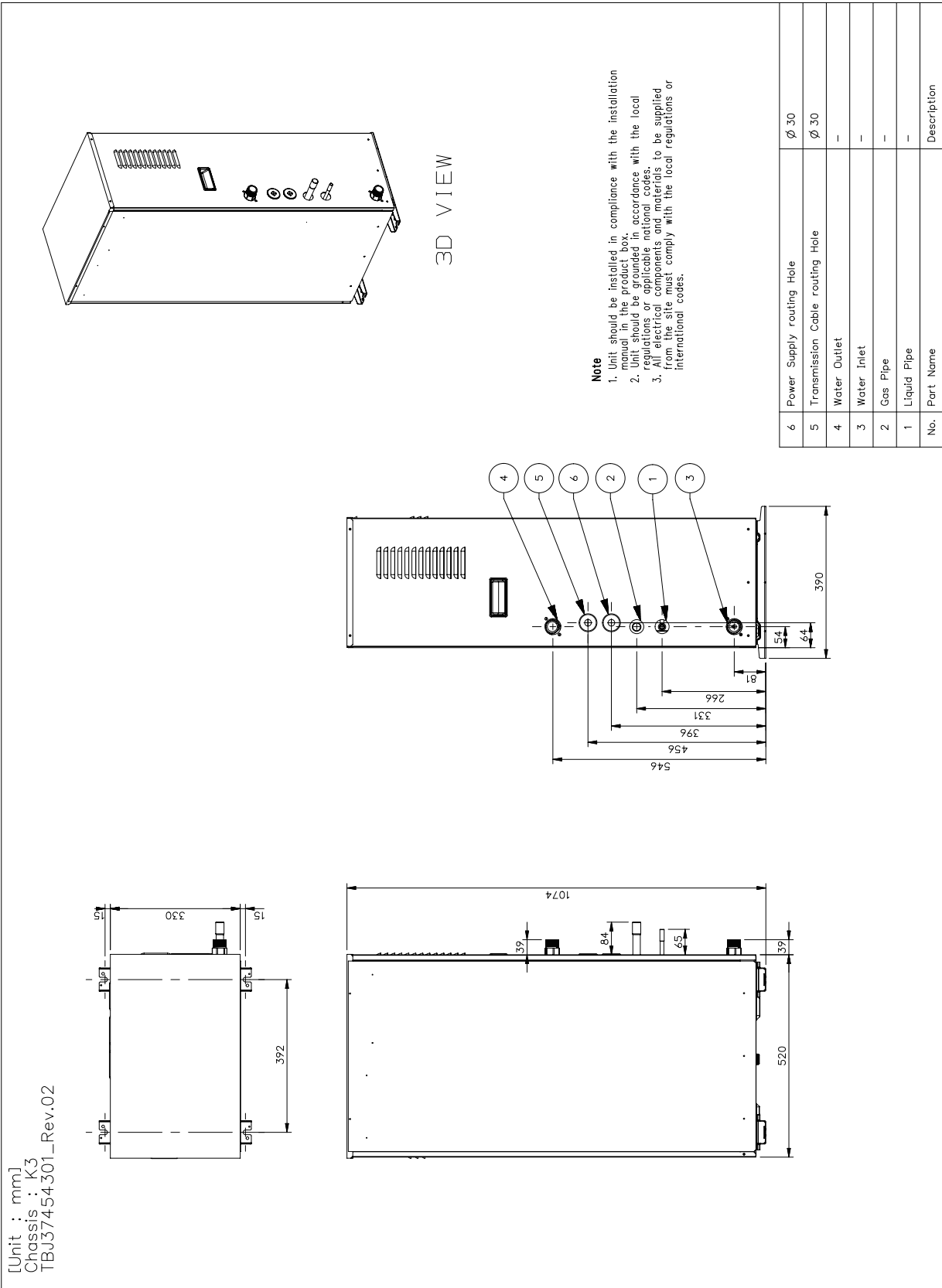

# 4. Piping diagrams

## ■ ARNH04GK3A4 / ARNH08GK3A4

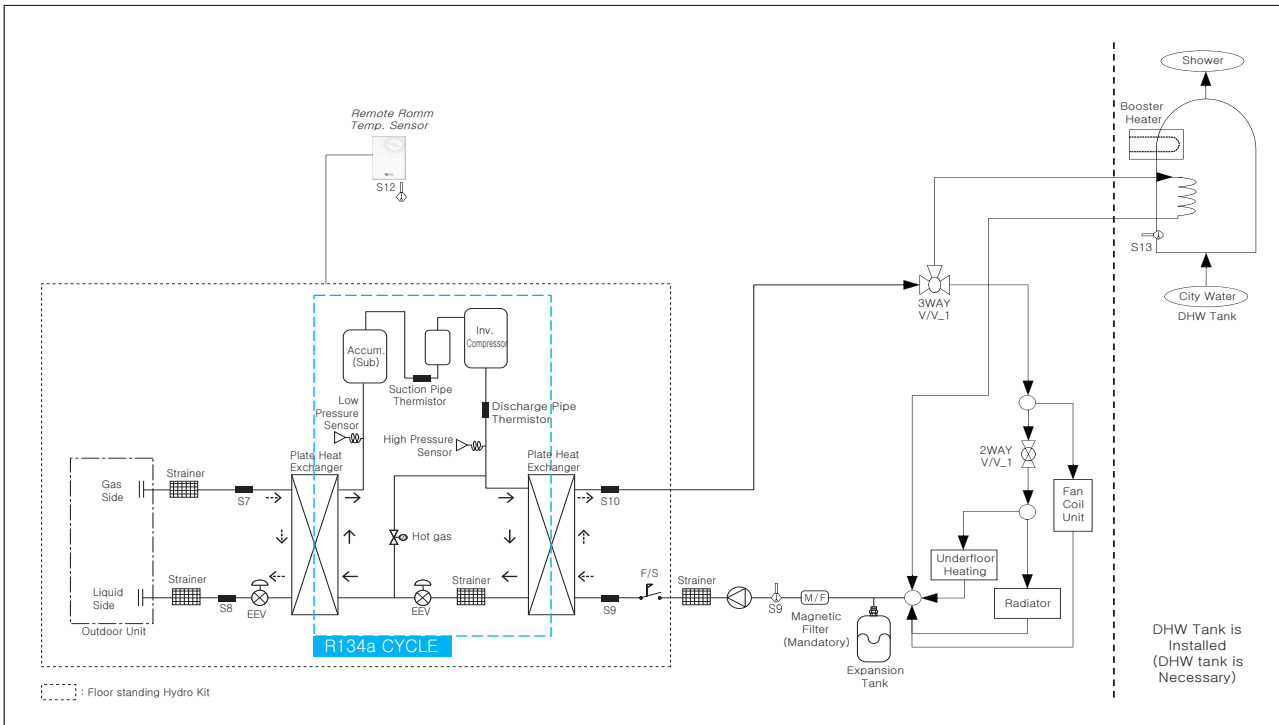

**Note**

The schematic diagram above is given for reference only.  
Actual schematic diagram may be different depending on the project requirement.

Category	Symbol	Meaning	PCB Connector	Remarks
Indoor Unit	S7	Refrigerant temperature sensor (Gas side)	CN_PIPE/OUT	- Meaning is expressed based on Cooling mode.
	S8	Refrigerant temperature sensor (Liquid side)	CN_PIPE/IN	
	S9	Entering Water temperature sensor	CN_TH3 (WATER IN) (PHEX OUT) (WATER OUT)	- S9, S10 are connected at 6 pin type connector CN_TH3.
	S10	Leaving Water temperature sensor		
	F/S	Flow switch	CN_FLOW1	- To monitor water flow in the system.
	S12	Remote Air sensor (Room 1/Direct circuit)	CN_ROOM	- Optional accessory (sold separately)
	CTR/PNL	Control Panel (or 'Remote Controller')	CN_REMO	- Pre built-in at indoor unit
Space Heating	2WAYV/V_1	Flow direction switching between Fan coil unit and floor heating/radiator	CN_2WAY_A	- 3rd party accessory and Field installation (sold separately) - 2 wire NO or NC type 2way valve is supported.
DHWHeating	DHW TANK	Water TANK	(no connector)	- Accessory and Field installation (sold separately) - Generating and storing DHW by Hydro kit or built-in backup heater
	Cold WATER	Water to be heated by Indoor unit and Booster Heater of W/TANK	(no connector)	- Field installation
	SHOWER	Water supplied to end-user	(no connector)	- Field installation
	S13	W/TANK water temperature sensor	CN_TH4	- S13 and S15 are connected at 4 pin type connector CN_TH4. - S13 is a part of DHW tank kit. - S14 is a part of solar thermal kit
Common	Expansion Tank	Expansion Tank	(no connector)	- Absorb volume change of heated water.
	M / F	Magnetic Filter	(no connector)	- 3rd party accessory and Field installation (sold separately)
	3WAYV/V_1	- Flow control for water which is leaving from indoor unit. - Flow direction switching between underfloor and water tank	CN_3WAY_A	- 3rd party accessory and Field installation (sold separately) - SPDT type 3way valve is supported.
	Water Pump Strainer	Water Pump Strainer	Pump(A) (no connector)	- Sold separately - Included in the product package

# 5. Wiring diagrams

## ARNH04GK3A4 / ARNH08GK3A4

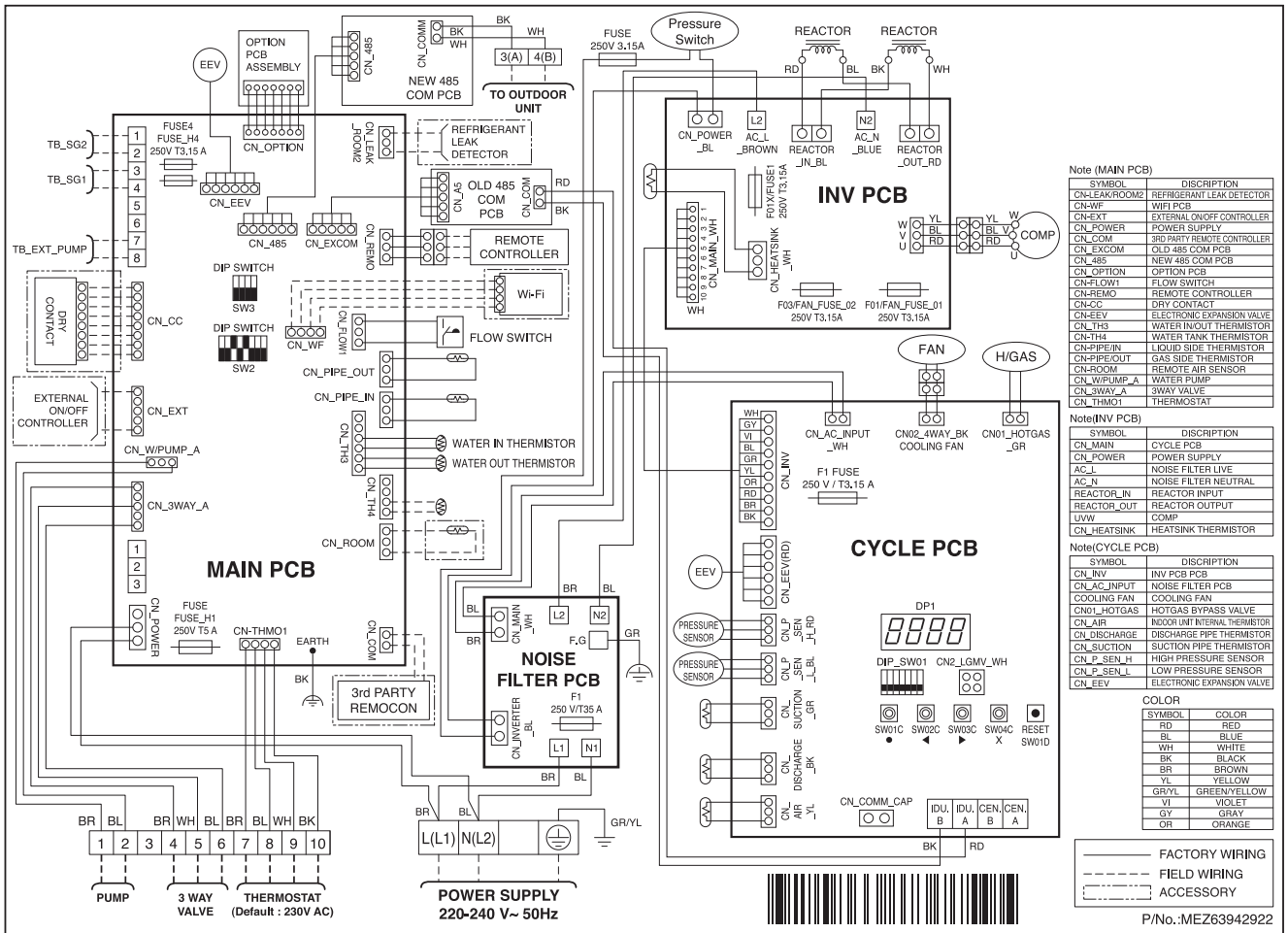

Note (MAIN PCB)

SYMBOL	DESCRIPTION
CN-EAKROOM2	REFRIGERANT LEAK DETECTOR
CN-WF	WIFI PCB
CN-EXT	EXTERNAL ON/OFF CONTROLLER
CN_POWER	POWER SUPPLY
CN_EXCOM	3RD PARTY REMOTE CONTROLLER
CN_485	OLD 485 COM PCB
CN_485	NEW 485 COM PCB
CN_OPTION	OPTION PCB
CN-FLOW1	FLOW SWITCH
CN-REMO	REMOTE CONTROLLER
CN-C2	DRY CONTACT
CN-EEV	ELECTRONIC EXPANSION VALVE
CN_TH3	WATER IN/OUT THERMISTOR
CN_TH4	WATER TANK THERMISTOR
CN-PIPE-IN	LIQUID SIDE THERMISTOR
CN-PIPE-OUT	GAS SIDE THERMISTOR
CN-ROOM	REMOTE AIR SENSOR
CN-WPUMP_A	WATER PUMP
CN_3WAY_A	3WAY VALVE
CN_THMO1	THERMOSTAT

Note (INV PCB)

SYMBOL	DESCRIPTION
CN_MAIN	CYCLE PCB
CN_POWER	POWER SUPPLY
AC_L	NOISE FILTER LIVE
AC_N	NOISE FILTER NEUTRAL
REACTOR_IN	REACTOR INPUT
REACTOR_OUT	REACTOR OUTPUT
UVW	COMP
CN_HEATSINK	HEATSINK THERMISTOR

Note (CYCLE PCB)

SYMBOL	DESCRIPTION
CN_INV	INV PCB PCB
CN_AC_INPUT	NOISE FILTER PCB
COOLING_FAN	COOLING FAN
CN01_HOTGAS	HOTGAS BYPASS VALVE
CN_AIR	INDOOR UNIT INTERNAL THERMISTOR
CN_DISCHARGE	DISCHARGE PIPE THERMISTOR
CN_SUCTION	SUCTION PIPE THERMISTOR
CN_P_SEN_H	HIGH PRESSURE SENSOR
CN_P_SEN_L	LOW PRESSURE SENSOR
CN_EEV	ELECTRONIC EXPANSION VALVE

COLOR

SYMBOL	COLOR
RD	RED
BL	BLUE
WH	WHITE
BK	BLACK
BR	BROWN
YL	YELLOW
GR/YL	GREEN/YELLOW
VI	VIOLET
GY	GRAY
OR	ORANGE

— FACTORY WIRING  
 - - - FIELD WIRING  
 ····· ACCESSORY

P/No.:MEZ63942922

## 6. Capacity correction factor

### 6.1 Capacity correction factor by temperature

#### ■ Capacity/Power Input Calculation method

**Total Capacity = Hydro Kit Capacity + Indoor Unit Capacity**

$$\text{Hydro Kit Capacity} = Q_{\text{ODU}} \times (I_{\text{HK}} / I_{\text{TOTAL}}) \times F_{\text{TC,T\_HK}} \times F_{\text{TC,W\_HK}} \times F_{\text{TC,P\_ODU}} \times F_{\text{TC,D\_ODU}}$$

$Q_{\text{ODU}}$  = Outdoor Unit capacity by outdoor air (outside inlet water) temp. and capacity ratio at standard indoor temp. .... Refer to [Capacity tables of outdoor unit PDB](#)

\* Standard indoor temperature is 27/19°C DB/WB on cooling mode, 20°C DB on heating mode.

$F_{\text{TC,T\_HK}}$  = Capacity correction factor by Outdoor and water inlet temperature. .... Refer to [following Graph of this PDB](#)

$F_{\text{TC,W\_HK}}$  = Capacity correction factor by Water flow rate. .... Refer to [following Graph of this PDB](#)

$F_{\text{TC,P\_ODU}}$  = Capacity correction factor by Refrigerant Piping length. .... Refer to [correction factors of outdoor unit PDB](#)

$F_{\text{TC,D\_ODU}}$  = Capacity correction factor by Defrosting operation. .... Refer to [correction factors of outdoor unit PDB](#)

$I_{\text{HK}}$  = Capacity index for Hydro Kit .... Refer to [index table of this PDB](#)

$I_{\text{TOTAL}}$  = Sum of Capacity index for combined indoor units and hydro kit .... Refer to [index table of outdoor unit PDB](#)

**Total Power Input = Hydro Kit Power Input + Indoor Unit Power Input**

$$\text{Hydro Kit Power Input} = [PI_{\text{ODU}} \times (I_{\text{HK}} / I_{\text{TOTAL}}) \times F_{\text{PI,T\_HK(O)}} \times F_{\text{PI,W\_HK(O)}}] + [PI_{\text{HK}} \times F_{\text{PI,T\_HK(H)}} \times F_{\text{PI,W\_HK(H)}}]$$

$PI_{\text{ODU}}$  = Outdoor Unit Power Input by outdoor air (outside inlet water) temp. and capacity ratio at standard indoor temp. .... Refer to [Capacity tables of outdoor unit PDB](#)

\* Standard indoor temperature is 27/19°C DB/WB on cooling mode, 20°C DB on heating mode.

$PI_{\text{HK}}$  = Hydro Kit Nominal Power Input .... Refer to [Specifications of this PDB](#)

$F_{\text{PI,T\_HK(O)}}$  = Power Input correction factor [Outdoor Unit] by Outdoor and water inlet temperature. .... Refer to [following Graph of this PDB](#)

$F_{\text{PI,W\_HK(O)}}$  = Power Input correction factor [Outdoor Unit] by Water flow rate .... Refer to [following Graph of this PDB](#)

$F_{\text{PI,T\_HK(H)}}$  = Power Input correction factor [Hydro Kit] by Outdoor and water inlet temperature. .... Refer to [following Graph of this PDB](#)

$F_{\text{PI,W\_HK(H)}}$  = Power Input correction factor [Hydro Kit] by Water flow rate .... Refer to [following Graph of this PDB](#)

$I_{\text{HK}}$  = Capacity index for Hydro Kit .... Refer to [index table of this PDB](#)

$I_{\text{TOTAL}}$  = Sum of Capacity index for combined indoor units and hydro kit .... Refer to [index table of outdoor unit PDB](#)

#### Note

- When calculating at upper or lower temperature than the range of Outdoor unit capacity table, use the same value with the boundary value of that. For example, when calculating Heating PI with capacity table of Outdoor unit at upper temperature than 15°CDB, use the same value of PI at 15°C DB.

## 6. Capacity correction factor

### ■ Combination with Multi V 5 system (ARU-5) and Multi V S system (ARU-S\*0) for Heating

#### ◆ Capacity correction factor

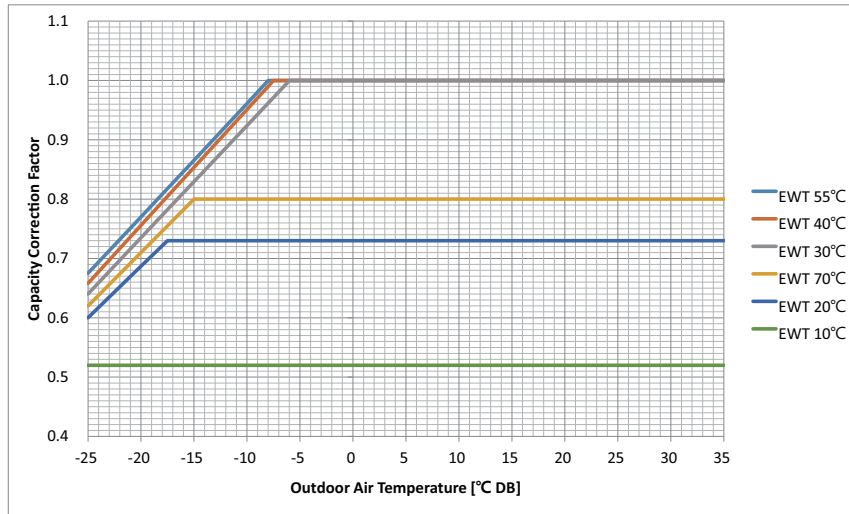

#### ◆ Power Input correction factor (Hydro Kit)

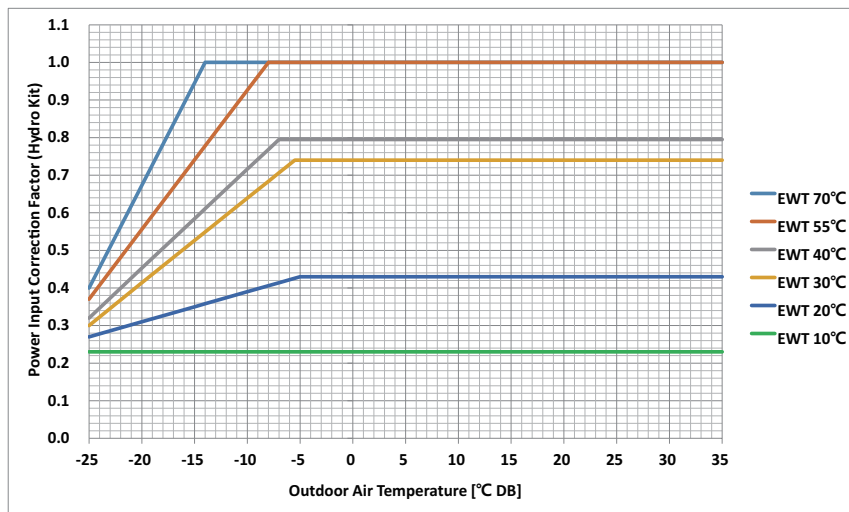

#### ◆ Power Input correction factor (Outdoor unit)

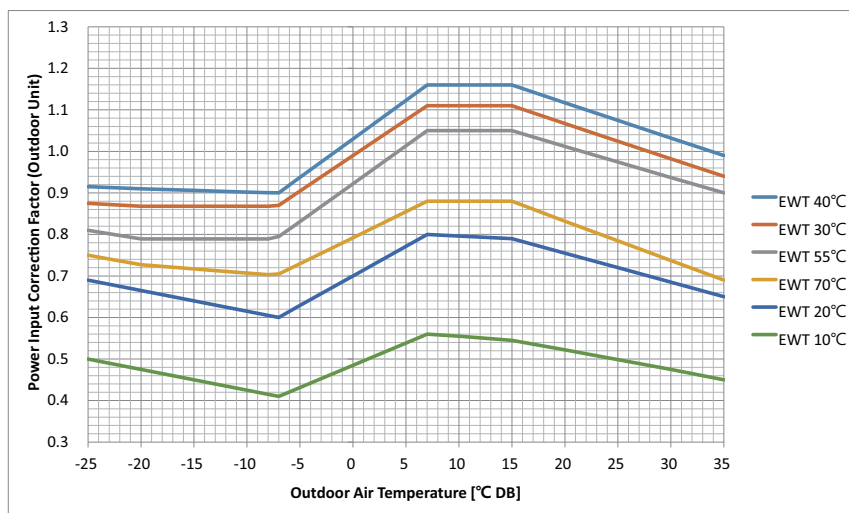

#### Note

Correction factor follows the outdoor unit operation range and cannot operate outside the operating range.



## 6. Capacity correction factor

### ■ Combination with Multi V Water system (ARW-) for Heating

#### ◆ Capacity correction factor

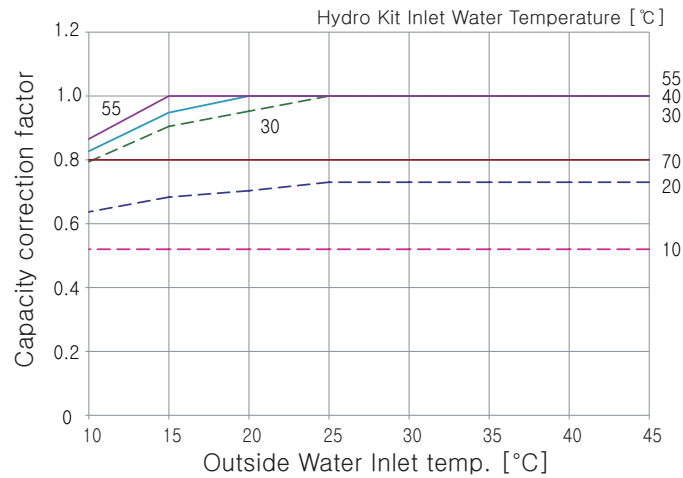

#### ◆ Power Input correction factor (Hydro Kit)

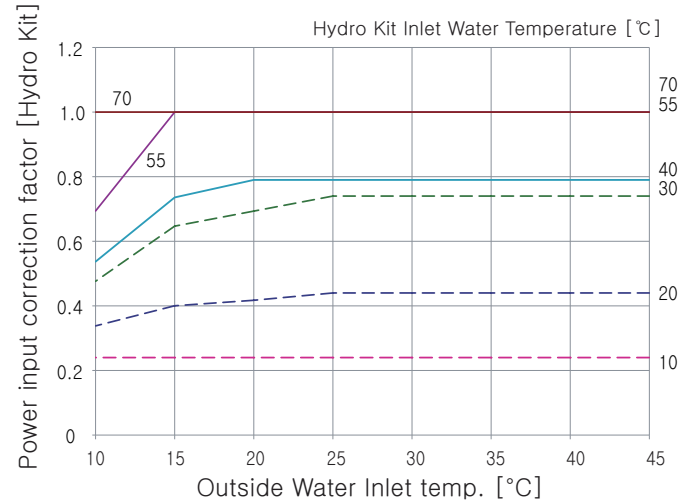

#### ◆ Power Input correction factor (Outdoor unit)

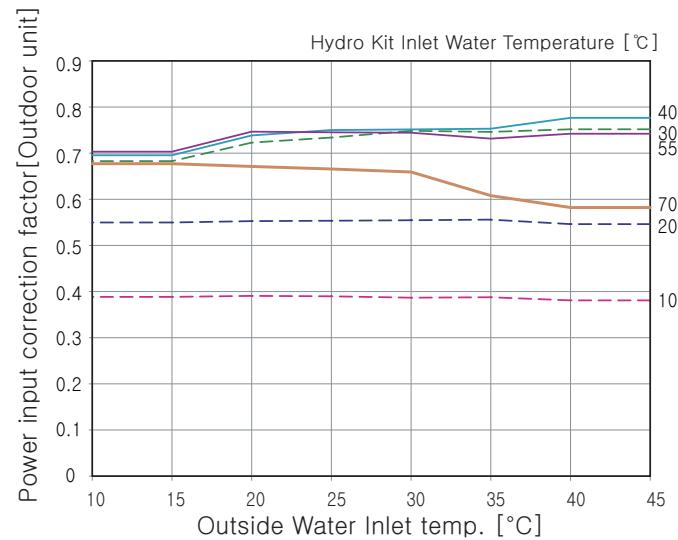

### Note

Correction factor follows the outdoor unit operation range and cannot operate outside the operating range.

## 6. Capacity correction factor

### 6.2 Capacity correction factor by water flow rate

■ Heating

◆ Capacity correction factor

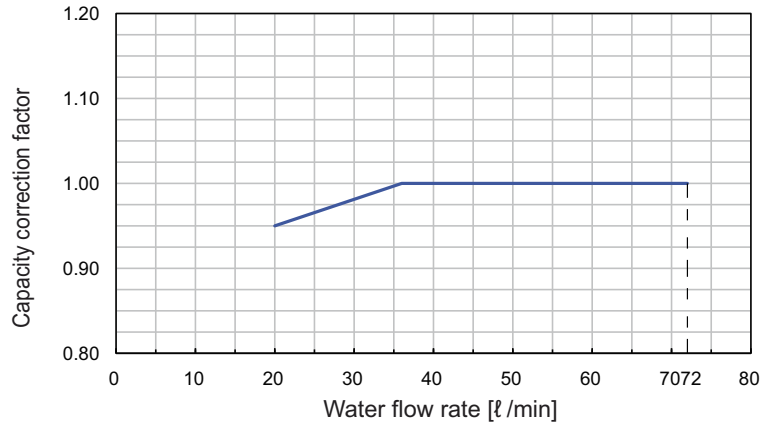

◆ Power Input correction factor (Hydro Kit)

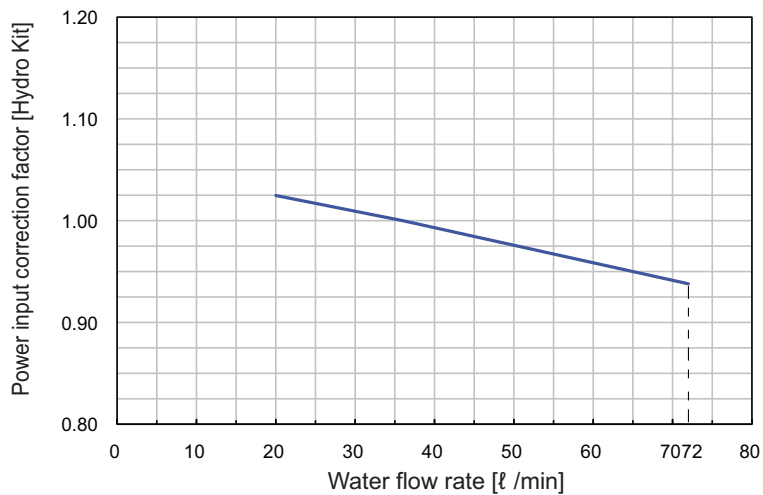

◆ Power Input correction factor (Outdoor unit)



**CAUTION**

Water Flow Rate Range (recommended) : ARNH04GK3A4 19.8 ~ 40 (ℓ/min), ARNH08GK3A4 20 ~ 72 (ℓ/min)

## 6. Capacity correction factor

### 6.3 Capacity correction factor by antifreeze

Antifreeze Type	Item	Antifreeze % by wt				
		10%	20%	30%	40%	50%
Methanol	Heating	0.995	0.990	0.985	0.979	0.974
	Pressure Drop	1.023	1.057	1.091	1.122	1.160
Ethylene glycol	Heating	0.993	0.985	0.977	0.969	0.961
	Pressure Drop	1.024	1.068	1.124	1.188	1.263
Propylene glycol	Heating	0.966	0.973	0.960	0.948	0.935
	Pressure Drop	1.040	1.098	1.174	1.273	1.405

#### ◆ Correction factor of heating capacity

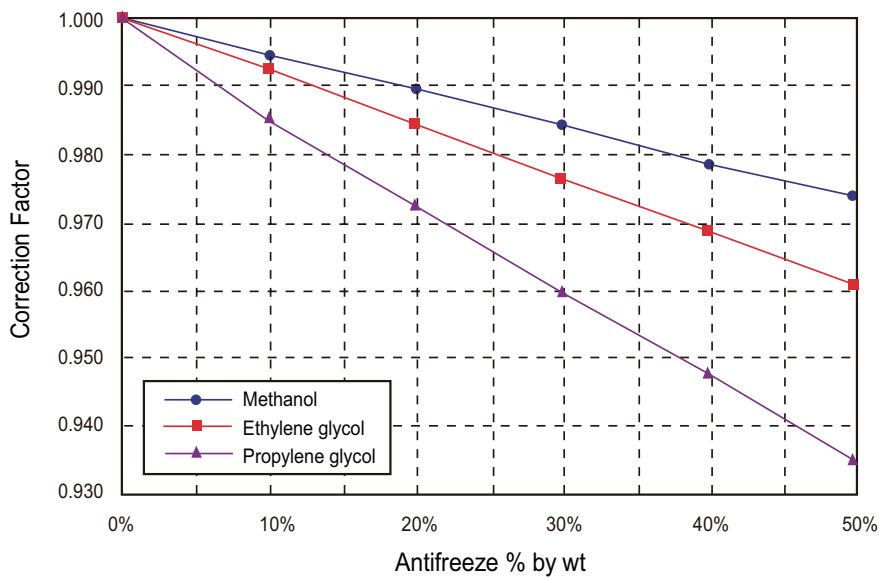

#### ⚠ CAUTION

Please apply antifreeze according to local regulation.

## 7. Water pressure drop

### ■ ARNH04GK3A4

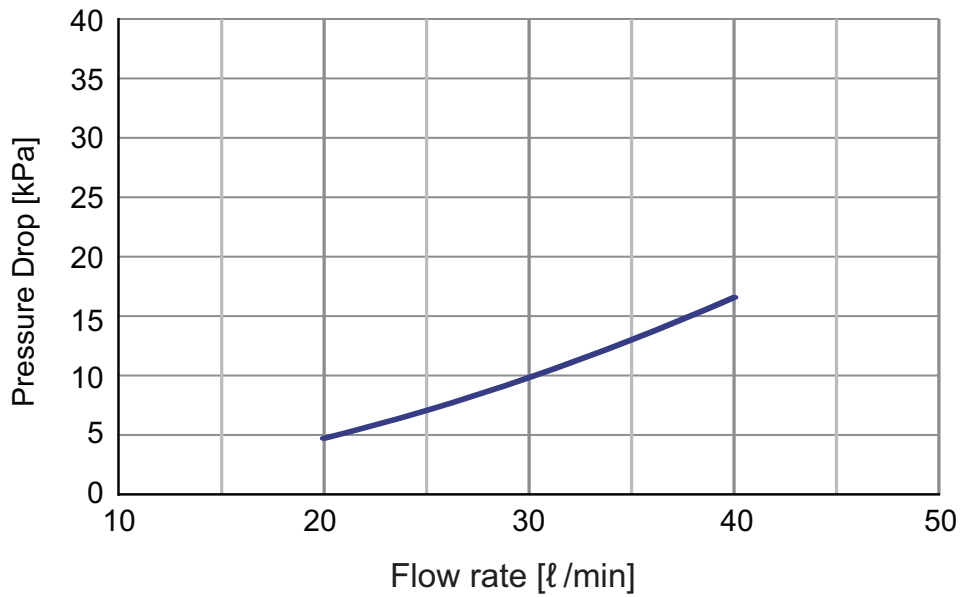

### ■ ARNH08GK3A4

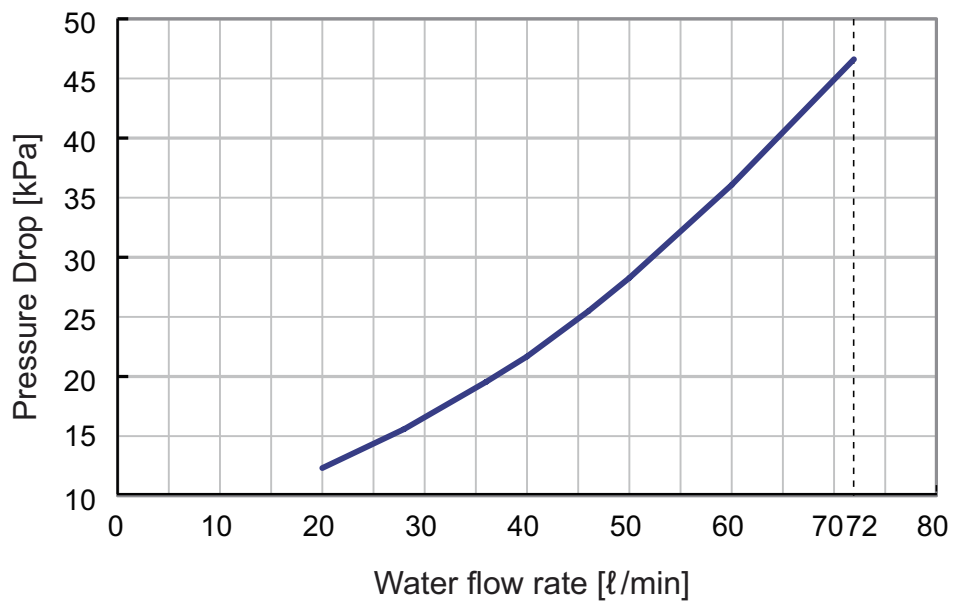

### ⚠ CAUTION

Water Flow Rate Range (recommended) : ARNH04GK3A4 19.8 ~ 40 (l/min), ARNH08GK3A4 20 ~ 72 (l/min)

## 8. Operation limits

### ■ ARNH04GK3A4 / ARNH04LK3A4 / ARNH08GK3A4 / ARNH08LK3A4

#### ◆ -RUM-----5,6(Heat Pump), ARUN-----5, ARUN-----0

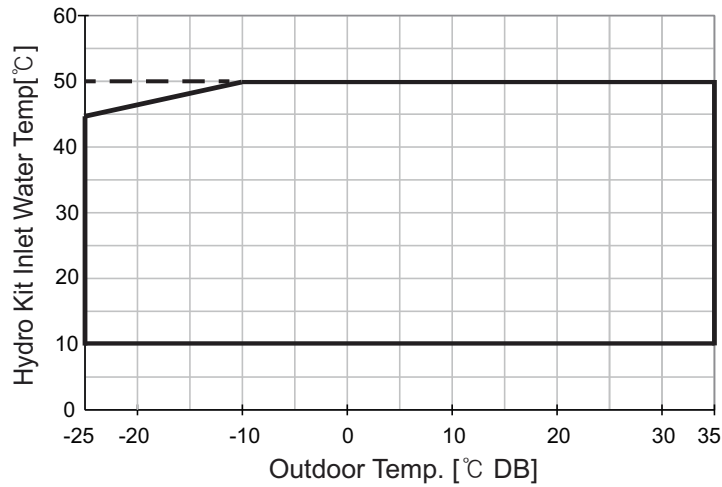

#### ◆ -RUM-----5,6(Heat Recovery), ARUB-----0(Heat Recovery)

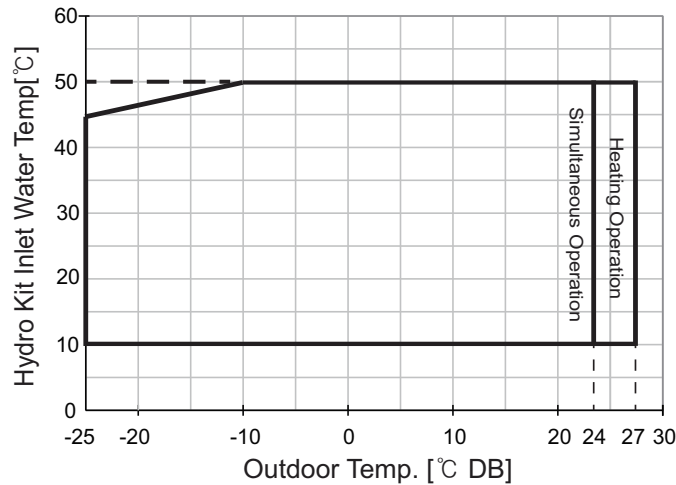

#### ◆ ARWN-series, ARWB-series

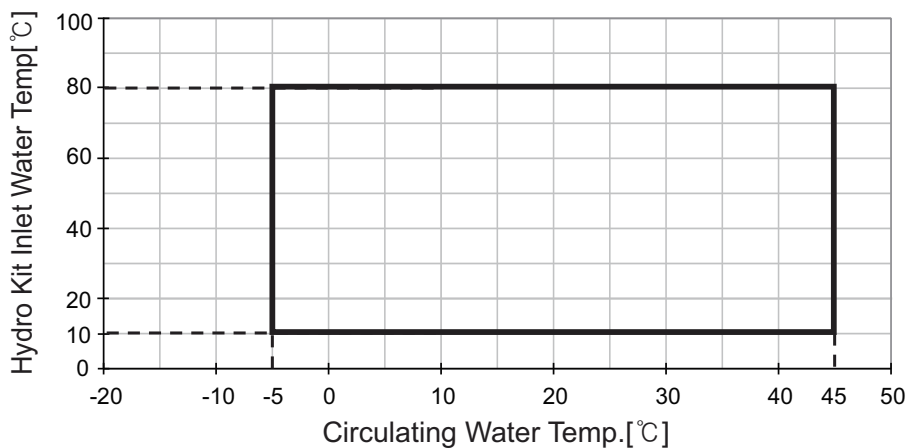

### Note

1. For only Hydro Kit combination, Maximum operation limit in heating is outdoor temperature 35°C DB / 24°C WB.
2. 'Simultaneous Operation' means other Indoor units are operating on cooling mode.
3. Operation limit follows the outdoor unit operation range and cannot operate outside the operating range. Also operation limit depends on product type and target region.

## 9. Electric characteristics

---

### ■ Wiring of Main Power Supply and Equipment Capacity

1. The power supply work is needed only to the outdoor unit. The power supply to the indoor unit or the BD unit is conducted through the transmission wiring. Therefore, the power supply work can be carried out at just one place of the outdoor unit. It will contribute to simplify the work procedure and to save cost.
2. Bear in mind ambient conditions (ambient temperature, direct sunlight, rain liquid, etc.) when proceeding with the wiring and connections
3. The wire size is the minimum value for metal conduit wiring. The power cord size should be 1 rank thicker taking into account the line voltage drops. Make sure the power-supply voltage does not drop more than 10%.
4. Specific wiring requirements should adhere to the wiring regulations of the region.
5. Power supply cords of parts of appliances for outdoor use should not be lighter than polychloroprene sheathed flexible cord.
6. Don't install an individual switch or electrical outlet to disconnect each of indoor unit separately from the power supply.

---

### WARNING

- Follow ordinance of your governmental organization for technical standard related to electrical equipment, wiring regulations and guidance of each electric power company.
- Make sure to use specified wires for connections so that no external force is imparted to terminal connections. If connections are not fixed firmly, it may cause heating or fire.
- Make sure to use the appropriate type of overcurrent protection switch. Note that generated overcurrent may include some amount of direct current.

---

### CAUTION

- All installation site must require attachment of an earth leakage breaker. If no earth leakage breaker is installed, it may cause an electric shock.
  - Do not use anything other than breaker and fuse with correct capacity. Using fuse and wire or copper wire with too large capacity may cause a malfunction of unit or fire.
-

## 9. Electric characteristics

Model	Type	Hz	Volts	Voltage Range	Power Supply			Compressor	
					MCA(A)	TOCA(A)	MFA(A)	MSC(A)	RLA(A)
ARNH04GK3A4	K3	50	220-240	Max:264 Min:198	18.2	20	25	-	10.56
	K3	60	220	Max:242 Min:198	18.2	20	25	-	10.56
ARNH08GK3A4	K3	50	220-240	Max:264 Min:198	26.2	27	30	-	23.00
	K3	60	220	Max:242 Min:198	26.2	27	30	-	23.00

### Symbols

**MCA** : Minimum Circuit Amperes (A)

**TOCA** : Total Over Current Amperes (A)

**MFA** : Maximum Fuse Amperes (A)

**MSC** : Maximum Starting Current (A)

**RLA** : Rated Load Amperes (A)

### Note

1. Voltage supplied to the unit terminals should be within the minimum and maximum range.
2. Maximum allowable voltage unbalance between phase is 2%.
3. MSC means the Max. current during the starting of compressor.
4. MSC and RLA are measured as the compressor only test condition.
5. OFM are measured as the outdoor unit test condition.
6. TOCA means the total over current value of each outdoor unit.
7. Select the wire size based on the larger value among MCA or TOCA.
8. MFA is used to select the circuit breaker and ground fault circuit interrupter, and all installation site must require attachment of an earth leakage breaker. [circuit breaker type is ELCB(Earth Leakage Circuit Breaker)].
9. Select the electrical equipment of combination unit according to the electrical characteristics of individual unit.

# 10. Sound levels

## 10.1 Sound Pressure Level

### Overall

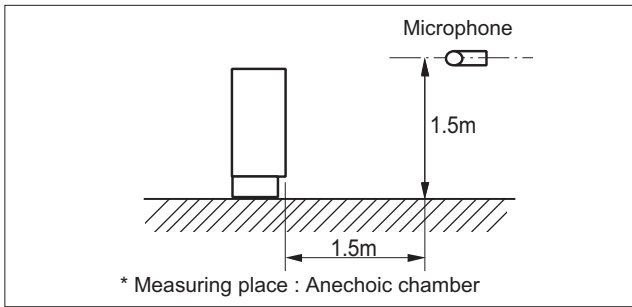

**Note**

1. Sound measured at some distance away from the center of the unit.
2. Data is valid at free field condition.
3. Reference acoustic pressure 0dB = 20μPa.
4. Data is valid at nominal operation condition. Refer to the Model Specifications for nominal conditions (Power source and Ambient temperature, etc)
5. Sound level will vary depending on a range of factors such as the construction (acoustic absorption coefficient) of particular room in which the equipment is installed.
6. Sound pressure level is measured on the rated condition in the anechoic rooms by ISO 3745 standard. Therefore, these values can be increased owing to ambient conditions during operation.

Model	Sound Level (dB(A))
ARNH04GK3A4	44
ARNH08GK3A4	46

**ARNH04GK3A4**

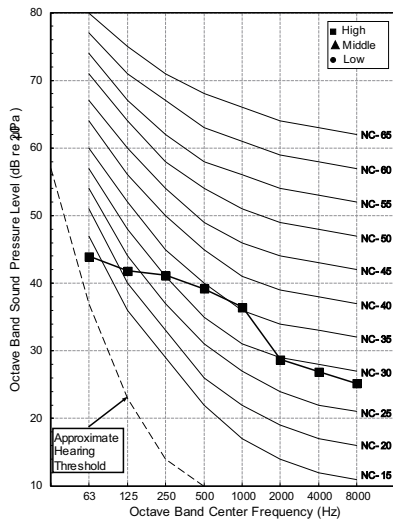

**ARNH08GK3A4**

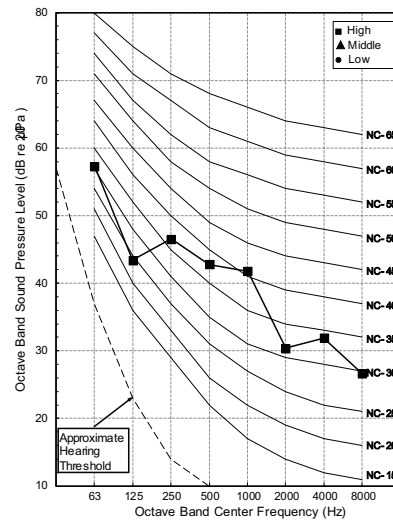



## Installation

### Installation of Indoor Unit

## 1. Information for Refrigerant

---

### 1.1 Alternative Refrigerant

*The type of refrigerant applied depends on the outdoor unit cycle configuration. Ensure the refrigerant type in the specification of the indoor unit and outdoor unit to be installed.*

#### ■ Alternative Refrigerant \_ R410A

- The refrigerant R410A has the property of higher operating pressure in comparison with R22. Therefore, all materials have the characteristics of higher resisting pressure than ones of R22 and this characteristic should also be considered during the installation.
- The wall thickness of the piping should comply with the relevant local and national regulations for the designed pressure. (R410A 3.8MPa)
- For high-pressure refrigerant, any unapproved pipe must not be used.
- Do not heat pipes more than necessary to prevent them from softening.
- Do not place the refrigerant container under the direct rays of the sun to prevent it from exploding.
- R410A is an azeotrope of R32 and R125 mixed at 50:50, so the ozone depletion potential(ODP) of R410A is 0.
- Since R410A is a mixed refrigerant, the required additional refrigerant must be charged in its liquid state.  
If the refrigerant is charged in its gaseous state, its composition changes and the system will not work properly.
- Be careful not to install wrongly to minimize economic loss because it is expensive in comparison with R22.

## 1. Information for Refrigerant

### 1.2 Caution For Refrigerant Leaks

The installer and system specialist shall secure safety against leakage according to local regulations or standards. The following standards may be applicable if local regulations are not available.

#### ■ Concentration limit : 0.44 kg/m<sup>3</sup> (for R410A)

Concentration limit (Freon gas weight per unit air volume, kg/m<sup>3</sup>) is the limit of Freon gas concentration where immediate measures can be taken without hurting human body when refrigerant leaks in the air.

#### ■ Calculate refrigerant concentration

Check concentration limit along following steps and take appropriate measure depending on the situation.

##### (1) Calculate total amount of refrigerant per each system (A, kg)

*Total amount of refrigerant in the system (A, kg)*

= Amount of pre-charged refrigerant per single system (B, kg) + Amount of additional replenished refrigerant (C, kg)

(B : Amount of replenished refrigerant at factory shipment)

(C : Amount of additionally replenished refrigerant depending on piping length or piping diameter by customer)

※ In case one refrigerant facility is divided into 2 or more refrigerant systems and each system is independent, amount of replenished refrigerant of each system shall be adopted.

##### (2) Calculate the volume of the room where indoor unit is installed as single room or the smallest room. (D, m<sup>3</sup>)

In case of room with partition and without opening which serve as passage of air to adjoining room, calculate the room space only.

- In case of room with partition but opened which serve passage of air to adjoining room, calculate the room space include space of adjoining room. (In the case of opening without door, or openings both above and below door which is more than space 0.15 % to floor space)

##### (3) Calculate refrigerant concentration.

*Refrigerant concentration*

= Total amount of refrigerant system (A, kg) ÷ Volume of smallest room where indoor unit is installed (D, m<sup>3</sup>)

[ Refrigerant concentration ≤ Maximum concentration (kg/m<sup>3</sup>, R410A is 0.44) ]

In case the result of calculation exceeds the concentration limit, perform the same calculations by shifting to the second smallest, and the third smallest rooms until at last the result is below the concentration limit.

#### ■ In case the concentration exceeds the limit

When the concentration exceeds the limit, change original plan or take one of the counter measure shown below:

- Counter measure 1

Provide opening 0.15% or more size of opening to floor space both above and below door for ventilation, or provide opening without door.

- Counter measure 2

Provide gas leak alarm linked with mechanical ventilator.

- Counter measure 3

Reducing the system's refrigerant quantity by deviding into smaller separate system.

#### < ! > CAUTIONS

Pay a special attention to the place, such as a basement, etc. where refrigerant can stay, since refrigerant is heavier than air.

## 2. Selection of the best Location

---

The unit should be installed inside where terminal of under floor water pipe cycle and refrigerant pipe from the outdoor unit are accessible at the same time. And specific conditions are required for installation place such as service space, wall mounting, water pipe length and height, total volume of water, adjusting expansion vessel, and water quality.

Select space for installing the unit, which will meet the following conditions, generally :

- Install in a separate machine room not exposed to external air directly.  
The installation place should be free from outdoor weather conditions such as rain, snow, wind, frost, etc.  
: *Temperature limitation of installed space : 0~32°C (32~89.6°F)*
- Establish an anti-freeze plan for the water supply when the product is stopped during the winter.
- The place should easily bear a load exceeding four times of the unit weight.
- The place should be where the unit is leveled.
- The floor of the installed room must be water proof. And in case water pressure rises over, water will be drained by safety valve, thus, drainage must be installed in the installed room to process the water drainage.
- Install a floor slope to make the drainage smooth.
- Do not install in upward direction. Install the drain pipe in downward direction (1/50-1/100).
- Do not place anything under the indoor unit to be free from unexpected water out in order to prevent things getting wet from unexceed water drips.
- The place should be where the unit is not affected by an electrical noise. Inverter product may generate electric noise. Keep the body from computer, stereo etc. at enough distance.
- The place should be where there should not be any heat source or steam near the unit.
- No flammable materials around the unit.
- Keep the unit free of any animal like rodents, etc.
- Install the unit where the noise from the machine room is not transferred outside.
- Enough service space should be secured according to field circumstance.

### 3. Foundation for Installation

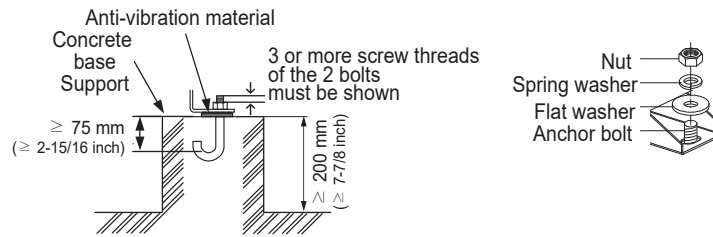

#### ■ Foundation for Installation (Floor standing type)

- Fix the unit tightly with bolts as shown below so that the unit will not fall down due to earthquake.
- Noise and vibration may occur from the floor or wall since vibration is transferred through the installation part depending on installation status. Thus, use anti-vibration materials (cushion pad) fully.  
(The base pad shall be more than 200 mm (7-7/8inch).)

## 4. Refrigerant Piping System

### 4.1 Connecting to Heat Recovery systems(HR unit 2 Series)

To connect 'Hydro Kit' to PRHR042 / PRHR032 / PRHR022

: Join 2 pipes with a 'Branch pipe' and Set the DIP SW.

(When connected indoor units' capacity is over than 54kBtu/h, one pipe connection is insufficient for refrigerant flow.)

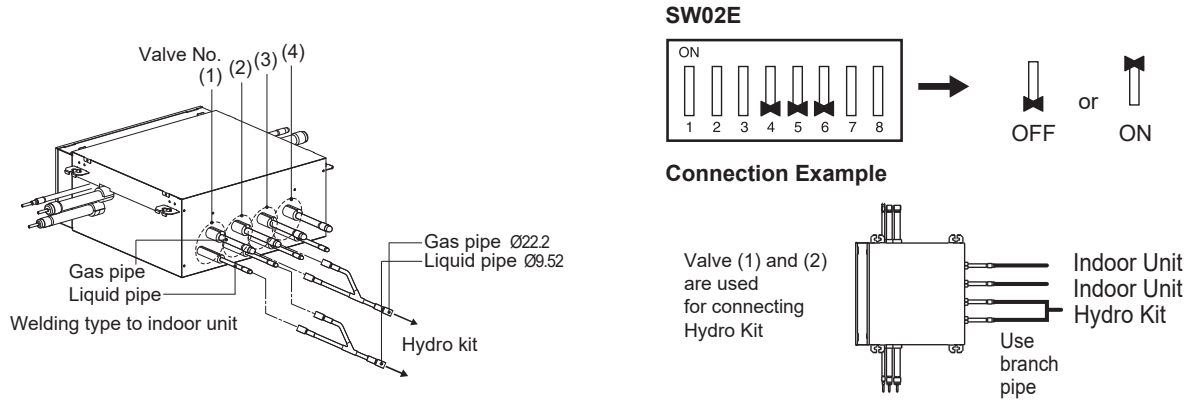

- One connection of refrigerant pipe for HR unit is insufficient for the flow of refrigerant to connect "Big" capacity indoor units. Join two pipes with a branch pipe when connected indoor units' capacity is over than 54kBtu/h. (Hydro Kit is over 10HP).
- The pipe number of the connected gas pipe and liquid pipe must be same.
- Flow water in the Hydro Kit when pipe-searching process is performed.
- Pipe-searching process error may occur if the pipe temperature does not increase.
- It is recommended that Hydro Kit (10HP model) is connected to No.1 valve and No.2 valve.

#### ■ Valve group control setting for Hydro Kit

Valve number to connect 'Indoor units'				Valve Control	DIP SW Setting		
#1	#2	#3	#4		SW No.4	SW No.5	SW No.6
Indoor unit	Indoor unit	Indoor unit	Indoor unit	Each	OFF	OFF	OFF
Hydro Kit		Indoor unit	Indoor unit	No. (1) + (2)	<b>ON</b>	OFF	OFF
Indoor Unit	Hydro Kit		Indoor unit	No. (2) + (3)	OFF	<b>ON</b>	OFF
Indoor unit	Indoor unit	Hydro Kit		No. (3) + (4)	OFF	OFF	<b>ON</b>
Hydro Kit		Hydro Kit		No. (1) + (2) / No. (3) + (4)	<b>ON</b>	OFF	<b>ON</b>

#### ■ Precaution on pipe searching process

1. Please choose the 'Mode' according to the water temperature.
  - Use 'Mode 1' if water temperature is higher than 30°C(86°F)
  - Use 'Mode 2' if water temperature is lower than 30°C(86°F)
2. Be sure that water pump is operating during the pipe searching process.
  - If the water circulation is not detected by water flow switch, 'CH14' error will occur.

#### <!/> NOTICE

For more detailed information, refer to the installation manual of Heat Recovery Unit.

## 4. Refrigerant Piping System

### 4.2 Connecting to Heat Recovery systems(HR unit 3 Series)

To connect 'Hydro Kit' to PRHR083 / PRHR063 / PRHR043 / PRHR033 / PRHR023

: Join 2 pipes with a 'Branch pipe' and Set the Rotary SW.

(When connected indoor units' capacity is over than 54kBTu/h, one pipe connection is insufficient for refrigerant flow.)

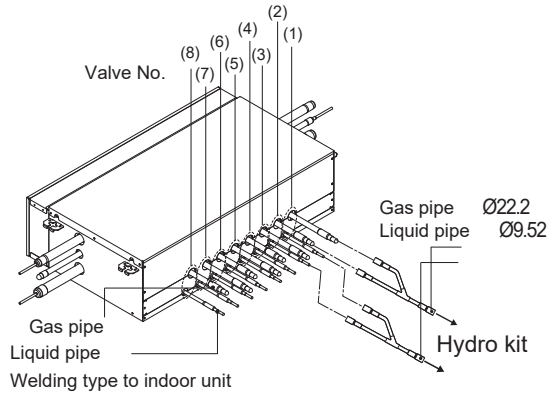

**SW01D (Rotary SW)**  
Selection of the Valve Group Control

Connection Example

Valve (1) and (2) are used for connecting Hydro Kit

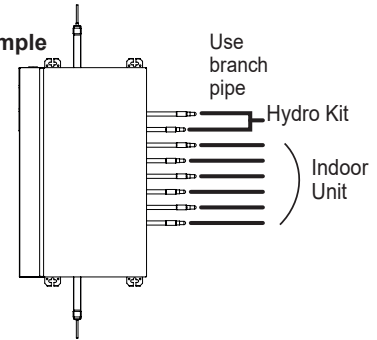

- One connection of refrigerant pipe for HR unit is insufficient for the flow of refrigerant to connect "Big" capacity indoor units. Join two pipes with a branch pipe when connected indoor units' capacity is over than 54kBTu/h. (Hydro Kit is over 10HP).
- The pipe number of the connected gas pipe and liquid pipe must be same.
- Flow water in the Hydro Kit when pipe-searching process is performed.
- Pipe-searching process error may occur if the pipe temperature does not increase.
- It is recommended that Hydro Kit (10HP model) is connected to No.1 valve and No.2 valve.

#### ■ Valve group control setting for Hydro Kit

Valve number to connected 'Indoor units'								Rotary SW setting
#1	#2	#3	#4	#5	#6	#7	#8	
Indoor unit	Indoor unit	Indoor unit	Indoor unit	Indoor unit	Indoor unit	Indoor unit	Indoor unit	0
Hydro Kit		Indoor unit	Indoor unit	Indoor unit	Indoor unit	Indoor unit	Indoor unit	1
Indoor unit	Hydro Kit		Indoor unit	Indoor unit	Indoor unit	Indoor unit	Indoor unit	2
Indoor unit	Indoor unit	Hydro Kit		Indoor unit	Indoor unit	Indoor unit	Indoor unit	3
Indoor unit	Indoor unit	Indoor unit	Indoor unit	Hydro Kit		Indoor unit	Indoor unit	4
Indoor unit	Indoor unit	Indoor unit	Indoor unit	Indoor unit	Hydro Kit		Indoor unit	5
Indoor unit	Indoor unit	Indoor unit	Indoor unit	Indoor unit	Indoor unit	Hydro Kit		6
Hydro Kit		Hydro Kit		Indoor unit	Indoor unit	Indoor unit	Indoor unit	7
Indoor unit	Indoor unit	Indoor unit	Indoor unit	Hydro Kit		Hydro Kit		8
Hydro Kit		Indoor unit	Indoor unit	Hydro Kit		Indoor unit	Indoor unit	9
Hydro Kit		Indoor unit	Indoor unit	Indoor unit	Indoor unit	Hydro Kit		A
Indoor unit	Indoor unit	Hydro Kit		Hydro Kit		Indoor unit	Indoor unit	B
Indoor unit	Indoor unit	Hydro Kit		Indoor unit	Indoor unit	Hydro Kit		C
Hydro Kit		Hydro Kit		Hydro Kit		Indoor unit	Indoor unit	D
Hydro Kit		Hydro Kit		Indoor unit	Hydro Kit		Indoor unit	E
Hydro Kit		Hydro Kit		Indoor unit	Indoor Unit	Hydro Kit		F

#### ■ Precaution on pipe searching process

1. Please choose the 'Mode' according to the water temperature.
  - Use 'Mode 1' if water temperature is higher than 30°C(86°F)
  - Use 'Mode 2' if water temperature is lower than 30°C(86°F)
2. Be sure that water pump is operating during the pipe searching process.
  - If the water circulation is not detected by water flow switch, 'CH14' error will occur.

#### <I> NOTICE

For more detailed information, refer to the installation manual of Heat Recovery Unit.

## 5. Electrical Wiring

---

### 5.1 General Instruction

For wiring work, it is recommended to consider the following:

- All field supplied parts and materials, electric works must conform to local codes. Use copper wire only.
- Follow the "**WIRING DIAGRAM**" attached to the unit body to wire the outdoor unit, indoor units and the remote controller.
- All wiring must be performed by an authorized electrician.
- A circuit breaker capable of shutting down the power supply to the entire system must be installed.

#### < ! > CAUTIONS

After the confirmation of the above conditions, prepare the wiring as follows:

- Never fail to have separate power specially for this unit.
- Provide a circuit breaker switch between power source and the unit.
- Confirm the Specification of power source. Confirm that electrical capacity is sufficient.
- Be sure that the starting voltage is maintained at more than 90 percent of the rated voltage marked on the name plate.
- Confirm that the cable thickness is as specified in the power sources specification.  
(Particularly note the relation between cable length and thickness.)
- Do not install the leakage breaker in a place which is wet or moist. Water or moist may cause short circuit.
- The following troubles would be caused by voltage drop-down.
  - Vibration of a magnetic switch, damage on the contact point there of, fuse breaking, disturbance to the normal function of a overload protection device.
  - Proper starting power is not given to the compressor.
  - All of the indoor units and outdoor units should be grounded. If grounding is not properly done, there is a risk of electric shock. Grounding must be done by a qualified technician.

#### ■ Wiring Connections

- Connect the wires to the terminals on the control board individually according to the outdoor unit connection.
- Ensure that the color of the wires of outdoor unit and the terminal No. are the same as those of indoor unit respectively.
- In case of the system with multiple indoor units, mark each indoor unit as unit A, unit B, etc and be sure the terminal board wiring to the outdoor unit and indoor units are properly matched.  
If wiring and piping between the outdoor unit and indoor unit are mismatched, the system may cause a malfunction.

#### < ! > CAUTIONS

- Make sure that the screws of the terminal are fixed tightly.
- The screw which fasten the wiring in the casing of electrical fittings are liable to come loose from vibrations to which the unit is subjected during the course of transportation. Check them and make sure that they are all tightly fastened.  
(If they are loose, it could give rise to burn-out of the wires.)
- Make sure to attach the sealing material or (field supplied) to hole of wiring to prevent the infiltration of foreign particle from outside. Otherwise a short-circuit may occur inside the electric parts box.
- When clamping the wires, be sure no pressure is applied to the wire connections by using the included clamping material to make appropriate clamps. Also, when wiring, make sure the cover on the electric parts box fits snugly by arranging the wires neatly and attaching the electric parts box cover firmly. When attaching the electric parts box cover, make sure no wires get caught in the edges. Pass wiring through the wiring through holes to prevent damage to them.
- Make sure the remote controller wiring, the wiring between the units, and other electrical wiring do not pass through the same locations outside of the unit, separating them properly, otherwise electrical noise (external static) could cause product malfunction.



## 5. Electrical Wiring

---

### 5.2 Installation of Wired remote controller(Optional)

- Since the room temperature sensor is in the remote controller, the remote controller box should be installed in a place away from direct sunlight, high humidity and direct supply of cold air to maintain proper space temperature.
- Install the remote controller about 1.5m (5ft) above the floor in an area with good air circulation at an average temperature.
- Do not install the remote controller where it can be affected by :
  - Drafts, or dead spots behind doors and in corners.
  - Hot or cold air from ducts.
  - Radiant heat from sun or appliances.
  - Concealed pipes and chimneys.
  - Uncontrolled areas such as an outside wall behind the remote controller.
- This remote controller is equipped with a seven segment LED display. For proper display of the remote controller LED's, the remote controller should be installed properly.  
(The standard height is 1.2~1.5 m (4~5ft) from floor level.)

## 6. Water Control

### 6.1 Water Quality

Water quality should be complied with EN 98/83 EC Directives.

**<I> IMPORTANT**

- If the product is installed at existing hydraulic water loop, it is important to clean hydraulic pipes to remove sludge and scale.
- Installing sludge strainer in the water loop is very important to prevent performance degrade.
- Chemical treatment to prevent rust should be performed by installer.
- It is strongly recommended to install an additional filter on the heating water circuit. Especially to remove metallic particles from the heating piping, it is advised to use a magnetic or cyclone filter, which can remove small particles. Small particles may damage the unit and will NOT be removed by the standard filter of the heat pump system.
- Water quality check should be implemented before completing the installation of system. Detailed guide can be found in the table as below.

Water Contents	Value			
pH	7.5 ~ 9.0			
Conductivity	10 ~ 500 $\mu$ S/cm			
TDS ( Total dissolved solids )	8 ~ 400 ppm			
Alkalinity ( $\text{HCO}_3^-$ )	60 ~ 300 (mg/L)			
Total hardness	4 ~ 8.5 °dH			
	71.4 ~ 151.7 (mg/L)			
Iron (Fe)	$\leq 0.2$ (mg/L)			
Sulphate ( $\text{SO}_4^{2-}$ )	$\leq 100$ (mg/L)			
Nitrite ( $\text{NO}_3^-$ )	$\leq 100$ (mg/L)			
Free chlorine ( $\text{Cl}_2$ )	$\leq 1$ (mg/L)			
Chlorides ( $\text{Cl}^-$ )	ppm		STS316	STS304
	pH7	15°C	3,000	180
		40°C	500	50
		60°C	200	30
		80°C	125	20
	pH9	15°C	18,000	700
		40°C	2,600	250
		60°C	1,000	170
80°C		550	130	

## 6. Water Control

### 6.2 Frost Protection

#### ■ Freezing Protection

- In areas of the country where entering water temperatures drop below specified temperature, the water pipe must be protected by using an approved antifreeze solution.
  - For Medium Temperature : below 15°C (59°F)
  - For High Temperature : below 0°C (32°F)
- Consult your Hydro Kit unit supplier for locally approved solutions in your area.
- Calculate the approximate volume of water in the system. (Except the Hydro Kit unit.) And add antifreeze solution to the total volume to allow for the water contained in Hydro Kit unit.
- Circulate the water with the pump before dropping the temperature.

Anti freeze type	Minimum temperature for anti freezing(°C)					
	Med. Temp. : 15°C High Temp. : 0°C	-5	-10	-15	-20	-25
Methanol (%)	0	6	12	16	24	30
Ethylene glycol (%)	0	12	20	30	-	-
Propylene glycol (%)	0	17	25	33	-	-

#### <I> CAUTIONS

- Use only one of the above antifreeze.
- If a antifreeze is used, pressure drop and capability degradation of the system can occur.
- If one of antifreezes is used, corrosion can occur. So please add corrosion inhibitor.
- Please check the concentration of the antifreeze periodically to keep same concentration.
- When the antifreeze is used (for installation or operation), take care to ensure that antifreeze must not be touched.
- Ensure to respect all laws and norms of your country about Anti-freeze usage.
- When hydro kit is applied for cooling, the antifreeze must be added in the water circuit to prevent freezing.
- Set the DIP S/W and short key to Anti Freeze mode only after the addition of brine(Anti-freeze). Or else the product may get damage due to freezing and bursting.
- Do not add brine(Anti-freeze) to the water circuit when it is used for hot water.

## 6. Water Control

### 6.3 Correction factor by antifreeze

If a antifreeze is used, pressure drop and capability degradation of the system can be occurred. Refer to the next table.

Antifreeze Type	Correction Factor Item	Antifreeze % by wt				
		10%	20%	30%	40%	50%
Methanol	Cooling Capacity	0.998	0.997	0.995	0.993	0.992
	Heating Capacity	0.995	0.990	0.985	0.979	0.974
	Pressure Drop	1.023	1.057	1.091	1.122	1.160
Ethylene glycol	Cooling Capacity	0.996	0.991	0.987	0.983	0.979
	Heating Capacity	0.993	0.985	0.977	0.969	0.961
	Pressure Drop	1.024	1.068	1.124	1.188	1.263
Propylene glycol	Cooling Capacity	0.993	0.987	0.980	0.974	0.968
	Heating Capacity	0.966	0.973	0.960	0.948	0.935
	Pressure Drop	1.040	1.098	1.174	1.273	1.405

## 7. Water Piping System

### ■ General Considerations

Followings should be considered before beginning water circuit connection

- Service space should be secured.
- Water pipes and connections should be cleaned using water.
- Space for installing external water pump should be provided.
- Never connect electric power while proceeding water charging.

### ■ Water Piping and Water Circuit Connection

While installing water pipes, followings should be considered :

- While inserting or putting water pipes, close the end of the pipe with pipe cap to avoid dust entering.
- When cutting or welding the pipe, always be careful that inner section of the pipe should not be defective.  
For example, no weldments or no burrs are found inside the pipe.
- Pipe fittings (e.g. L-shape elbow, T-shape tee, diameter reducer, etc) should be tightened strongly to be free from water leakage.
- Connected sections should be leakage-proof treatment by applying tefron tape, rubber bushing, sealant solution, etc.
- Appropriate tools and tooling methods should be applied to prevent mechanical breakage of the connections.
- Operation time of flow valve (e.g. 3way valve or 2way valve) should be less than 90 seconds.
- Pipe is insulated to prevent heat loss to external environment.

### ■ Safety Decives requirements for Water Cycle

- For selecting the components of the hydraulic system, be sure they are above the design water pressure.
  - For the water pipe, diffusely tight water pipes are recommended instead of steel pipes.
  - For the drain pipe size, use the same diameter as the product connected or larger. Always install a natural drainage so that the drained water does not flows back.
  - Install insulated material across the total hydraulic piping to prevent condensation and to prevent low cooling or heating capacity due to heat transfer losses. If the temperature is higher than 30 °C and the humidity is higher than 80 %, the insulation material must be minimum 20 mm thick to prevent condensation.
  - Install the closed loop type water pipe system.
  - After product operation for 2 weeks in case of new installation, clean the water filter. In the beginning of operation small particular dirt from installing process can block the filter which can lead to damage of the product.
- It may vary depending on the safety device included in the product or the installation/facility environment, appropriate devices and tools should be applied to prevent mechanical breakage of the cycle.
- (1) *Shut-off valve* : It needs for blocking the water by closing the valve when replacing the component or cleaning.
  - (2) *Expansion tank* : Install should be based on the water volume of the hydraulic system.
  - (3) *Drain valve(service port)* : It can be used for draining the water inside when replacing the component or providing service at each inlet and outlet of the water pipe.
  - (4) *Magnetic dirt separator* : Install at the inlet water pipe. If the air separator is not installed there can be formed air bubbles inside the hydraulic system. Flow error will be showed first on remote controller, however finally a plate heat exchanger may burst during combined circumstances.
  - (5) *Circulation pump* : Install what meets the water flow according to 'specifications' for product.
  - (6) *Strainer* : Install at the inlet water pipe connection to protect the PHE. Do not charge water into the water pipe directly during Hydro Kit operation. If the strainer is not installed, component malfunction of Hydro Kit may occur.
    - For the strainer, use one with 30 mesh or above with measurement diameter of 0.8 mm or less.
    - Check the strainer direction and assemble on the inlet hole.
    - Always install the strainer on the horizontal pipe.
    - Install the service port facing downward. (Within left/right 45 degrees)
    - Wrap the Teflon tape on the screw thread of the water pipe for more than 15 times for assembly.
    - Check if there is any leakage on the connecting part.
    - Clean the strainer periodically. (Once a year or more frequent)
  - (7) *Balancing valve (with flow meter)* : It is recommended to ensure 100% of the nominal flow.
  - (8) *Automatic air separator* : Install in the outlet water pipe
  - (9) *Pressure safety relief valve* : Install in vertical upright position that meets the design water pressure to prevent unit or water pipe damage during pressure increase inside the water pipe system.
  - (10) *Pressure meter* : Install in the outlet water pipe.
  - (11) *Flow-check valve* : In case of cascade hydraulic systems or bivalent systems, Install at each outlet water pipe.
  - (12) *Buffer tank* : If there is no buffer tank installed, the product can be damaged during normal operation or defrost operation. Install at least 10 l/kW heating capacity in order to have a correct defrost cycle, if there is no knowledge about the type and dimensions of the heating system.



**Air Solution**

LG Electronics Inc, 128, Yeoui-daero,  
Yeongdeungpo-gu, Seoul, Korea  
(07336)  
<http://partner.lge.com>

Copyright © 2021-2024 LG Electronics Inc.  
All Rights Reserved.  
Printed in Korea March / 2024

The air conditioners manufactured by LG have received ISO9001 certificate for quality assurance and ISO14001 certificate for environmental management system.  
The specifications, designs, and information in this brochure are subject to change without notice.