

Introduction of

Small Server Room Cooling Solution

Using Standard III Remote Controller with Single Split



November `21
Air Solution Engineering Control Team

Contents

1. Introduction

- **What is Server Room?**
- **What does the Solution provide?**
- **Line-up**

2. Stable & Reliable Operation

- **Duty Rotation**
- **Failure Back-up Operation**
- **CH03 Error Back-up + Fault Tolerance**
- **Capacity Back-up Operation**

3. Easy Installation

- **Simple System Compared to Dry Contacts**
- **Simple System Compared to Central Controllers**

4. Installation and Settings

- **Differences Compared to Group Control**
- **Settings for Server Room Solution**
- **Settings Related to the Server Room Solution**

What is Server Room?

A Server room is a facility composed of networked computers and storage that businesses and other organizations use to organize, process, store and disseminate data in the building.

What is Server Room?



Power Supply Unit



Network



Server Rack Mount

Characteristics

➤ Characteristics :

- Usually under IT control, may have some dedicated power and cooling capabilities.
- Generally server room needs to be **operated 24/7.**
- Computer and electric equipment **constantly generate heat,** and are sensitive to heat, humidity, and dust.
- Local server rooms in office, hotel or hospital buildings have relatively smaller cooling capacity than those in the data center.
- Limited space for installation of cooling system

What Does a Server Room Need?

➤ Server room operated 24/7

- **Constant cooling for 24/7/365**
- Energy efficiency system with high performance
- **Automatic failure back-up cooling system**

➤ Server room constantly generates heat

- Easy control & monitoring
- Remotely monitored
- **Capacity back up system**

➤ Limited space for installation

- Compact size of indoor units
- Easy and Simple installation
- Long pipe for flexible design and installation

What Does the Solution Provide?

Server Room Cooling Solution provides these values; Stable & Reliable operation, Easy installation and Convenience that the server room and users need.

Stable & Reliable Operation

It makes optimal condition for the equipment in the server room to do its own roles

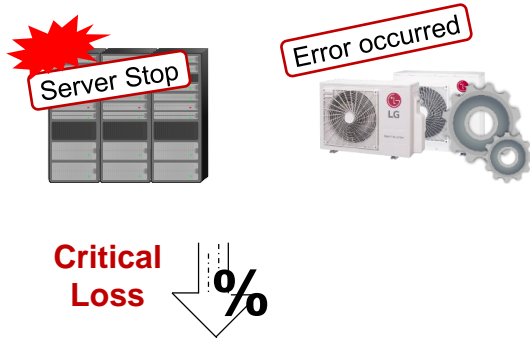

→ Safety Functions for Server Room

- Duty Rotation
- Capacity Back-up Operation
- Failure Back up Operation

Convenience

Optimal Indoor unit with easy management for the server room



→ Easy Management by using remote controller

Users can easily manage the server room by using one wired remote controller.

Easy Installation









LG provides installation convenience for server room solution

→ Simple Installation

LG solution provides all control and functions without multiple individual controllers, nor additional accessories(dry contacts).

Various capacities of single split ODU and IDU for the small server room solution.

Line-up

	kW	2.5	3.4	5.0	6.8
Outdoor Unit	Single Split	 UUA1 UL0	 UUA1 UL0	 UUB1 U20	 UUC1 U40
Indoor Unit	Wall Mounted Type Standard Plus	 MJ09PC NSJ	 MJ12PC NSJ	 MJ18PC NSK	 MJ24PC NSK

Typical Scene

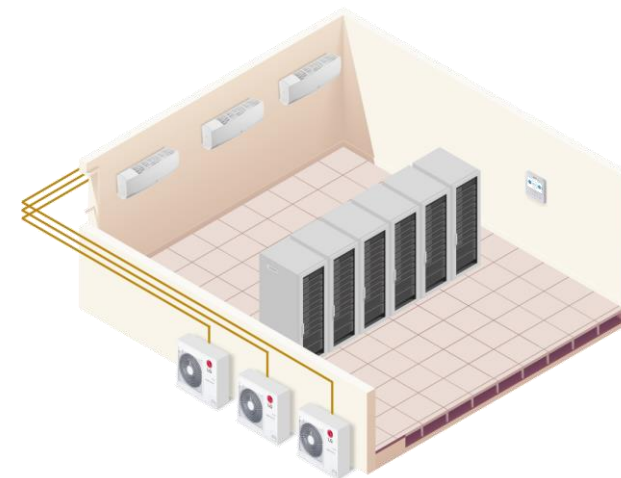

LG Small Server Room Cooling Solution Summary

- Purpose : Cooling small sized server room (IDU #2~4 units)
- ODU : Single Split + IDU : Wall mounted type
- Capacity : 2.5kW, 3.4kW, 5.0kW, 6.8kW
- Refrigerant pipe solution : No duct arrangement and good for limited ceiling height
- Extremely safe and optimal solution for server rooms by single split to cover ODU errors and insufficient capacities.
- Safety functions without any accessories : Duty Rotation, Capacity Back-up. Failure Back up
- Only one(1) remote controller for all(2~4) indoor units.

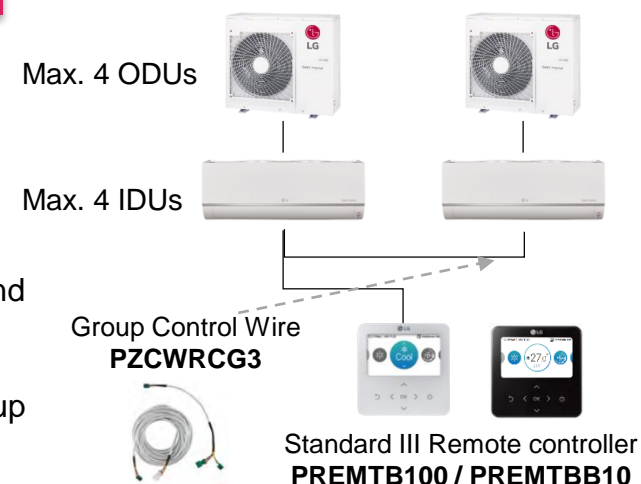

Duty Rotation

Stable & Reliable Operation

Operates more than 2 sets of indoor units alternatively at every rotation interval time.

Without Duty Rotation

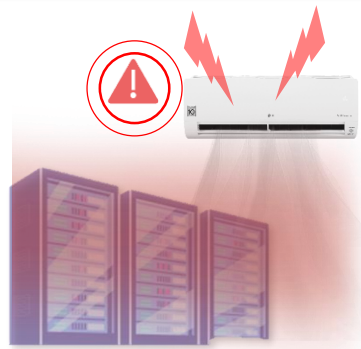

➤ Air Conditioners' Overwork

- Reducing air conditioner's life time
- Reducing compressor's life expectancy
- The service cost may increase due to air conditioner's overwork

With Duty Rotation



➤ Stable & Safe Operation

- Stable operation since indoor units take turns
- Smaller breakdown chances and keeping server room in operation
- Increase air conditioner's life expectancy
- Rotation interval can be set from 1h to 999h freely.

Operation Scenario

➤ When the number of the indoor units : 2

If the interval time is set to 24hours(default),

- ① While IDU #1 operates during interval time, IDU #2 is on standby.
- ② IDU #2 operates next 24 hours, and IDU #1 goes into standby.

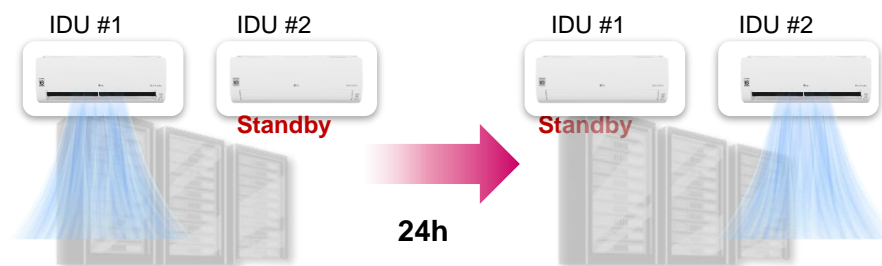

Duty Rotation

Stable & Reliable Operation

Operates more than 2 sets of indoor units alternatively at every set time of operation interval.

Operation Scenario

Icon	Description
	Duty Rotation is working properly

➤ When the number of the indoor units : 2

If the interval time is set to 24h(default),

- ① While IDU #1 operates during interval time, and IDU #2 is on standby.
- ② IDU #2 operates next 24 hours, and IDU #1 goes into standby.

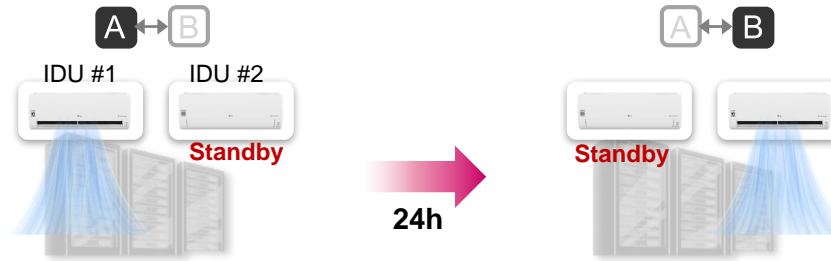

➤ When the number of the indoor units : 3

- ① While IDU #1 and IDU #2 operate during interval time, IDU #3 is on standby.
- ② The order of standby goes reversely: IDU #3 → IDU #2 → IDU #1.

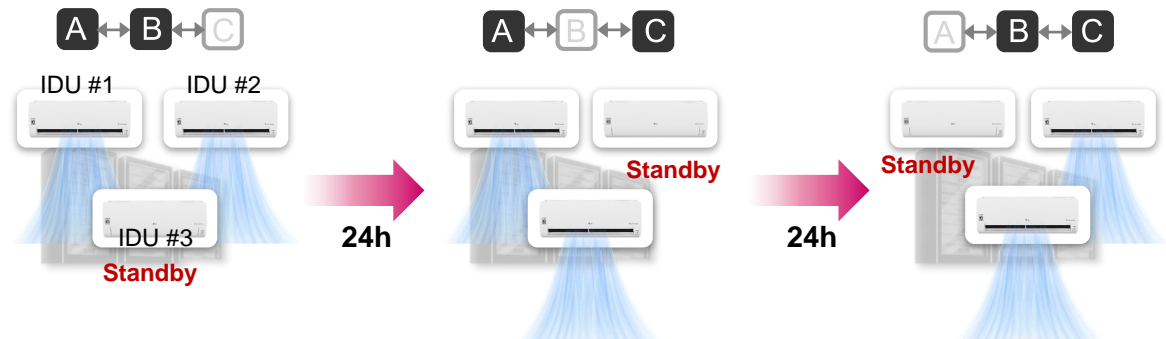

➤ When the number of the indoor units : 4

- ① While IDU #1, IDU #2 and IDU #3 operate during interval time, IDU #4 is on standby.
- ② The order of standby goes reversely: IDU #4 → IDU #3 → IDU #2 → IDU #1

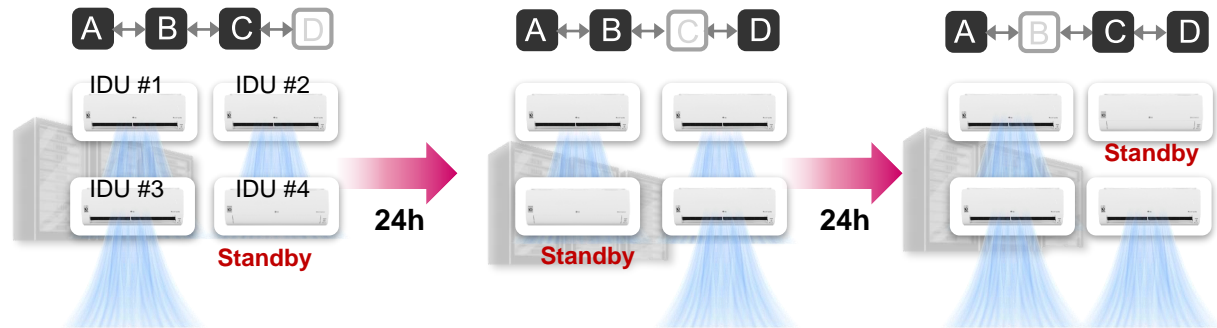

Failure Back-up Operation

Stable & Reliable Operation

If an error occurs in systems in operation and the system stops, the standby unit starts operation automatically.

Without Failure Back-up

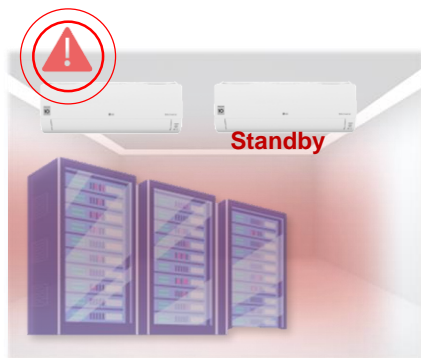

➤ Server can be Shut Down

- Server room overheats and server can be shut down.
- Probability for increase service cost
- Need manual monitoring and operation for failure

With Failure Back-up



➤ Stable & Safe Operation

- Stable operation because the operation error can be covered by failure back-up operation
- Keep server operation and decrease risk
- Protect server from overheating
- Less manual work

Operation Scenario

➤ When the number of the indoor units : 2

- ① When duty rotation is enabled, IDU #1 is in operation and IDU #2 is on standby.
- ② If an error occurs on IDU #1, standby unit starts operation.
- ③ After the error is cleared, IDU #2 goes back to standby.

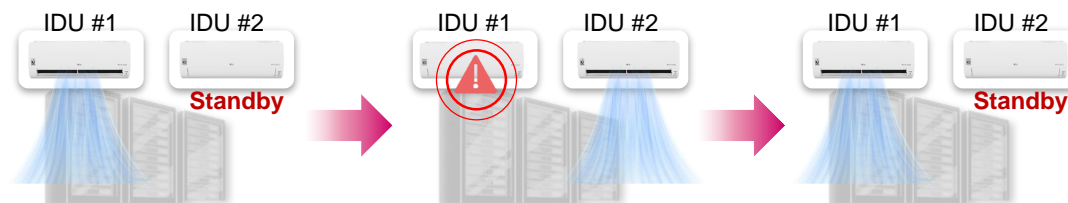

Failure Back-up Operation

Stable & Reliable Operation

If an error occurs in systems in operation and the system stops, the standby unit starts operation automatically.

Operation Scenario

Icon	Description
	Error occurs in IDUs

➤ When the number of the indoor units : 2

- ① When duty rotation is enabled, IDU #1 is in operation and IDU #2 is on standby.
- ② If an error occurs in IDU #1, standby unit starts operation.
- ③ After the error is cleared, IDU #2 goes back to standby.

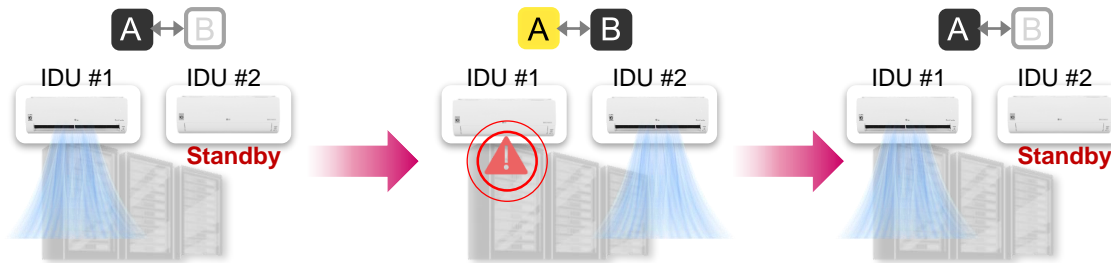

➤ When the number of the indoor units : 3

- ① When duty rotation is enabled, one unit is on standby.
- ② If an error occurs in any system, standby unit starts operation.
- ③ After the error is gone, the order of standby goes reversely: IDU #3 → IDU #2 → IDU #1.

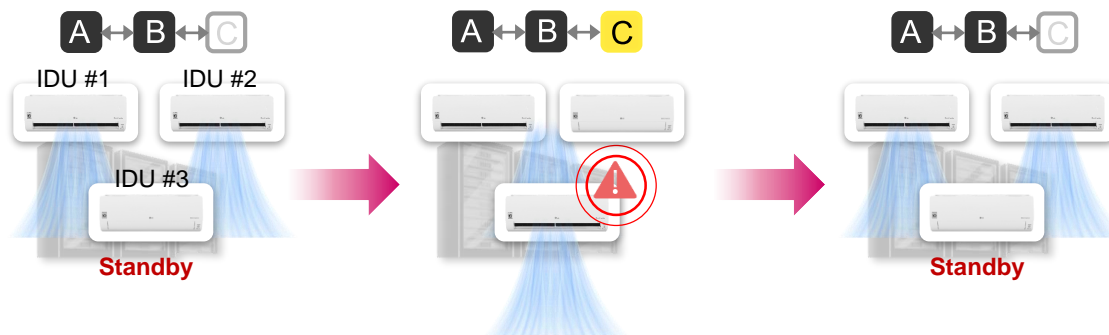

➤ When the number of the indoor units : 4

- ① When duty rotation is enabled, one unit is on standby.
- ② If errors occur in any system, standby unit starts operation.
- ③ If errors continue in any system, all units are in operation until all errors are cleared.
- ④ After error is cleared, the order of standby goes reversely: IDU #4 → IDU #3 → IDU #2 → IDU #1.

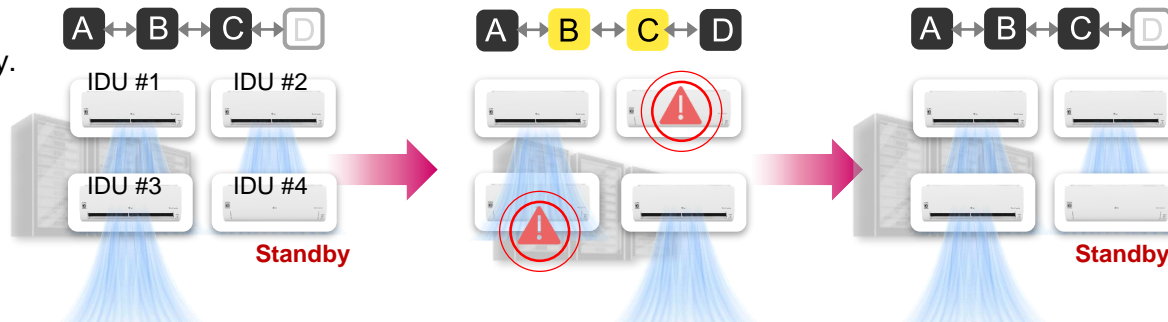

CH03 Error Back-up + Fault Tolerance

Stable & Reliable Operation

※ CH03 : No communication between wired remote controller & indoor unit

If the operation of the system stops unexpectedly due to an error (e.g.: communication), the system can be operate and be controlled by LG wireless remote controllers until the error is cleared.

Typical Logic

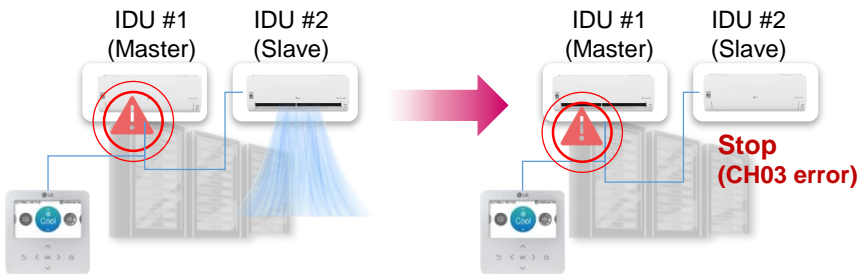

CH03 Failure Back-up + Fault Tolerance

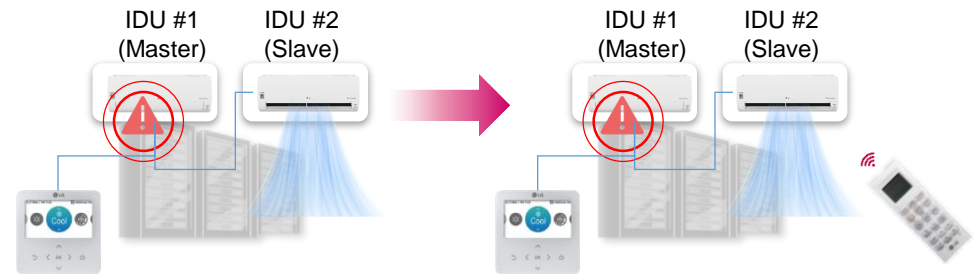

- In case of communication failure* of IDU#1(Master), all IDUs will be stopped.

* Communication failure happens due to Remote controller fault, Indoor unit PCB fault, Power failure, Connector fault, Wrong connection or Communication cable problem

- **Keep operating despite of the CH03 error.**

* Default option during server room solution

Operation Scenario

- When the number of the indoor units : 2

- ① In case of **power failure** of IDU#1(Master), the remote controller connected to IDU#1 is also turned off.
→ It may cause CH03 errors for the other IDUs.
- ② If the communication error has occurred between remote controller and IDUs,
→ It can cause CH03 errors for all IDUs.
- ③ **All the IDUs will be stopped.**

- ① If the IDUs were set to server room settings, **CH03 error will be ignored.**
- ② The normal IDUs maintain previous operating status.
- ③ The emergency control is also possible **using the wireless remote controllers.**

Capacity Back-up Operation

Stable & Reliable Operation

When the difference between the cooling set temp. and the current room temp. is higher than the **set temperature difference of capacity back-up**, the standby unit operates.

Without Capacity Back-up

➤ Server can be Overheated

- Sometimes server room can be overheated because of overload
- Server can be shut down when they overheat continuously
- If when air conditioners overload, manual controls are needed for additional cooling

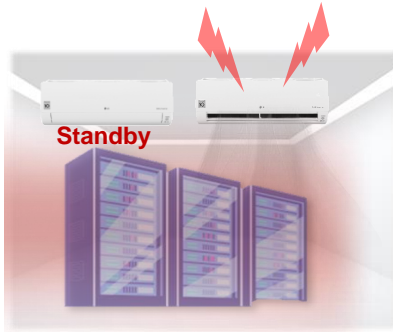

With Capacity Back-up

➤ Stable & Safe Operation

- Stable operation due to the excessive capacity back-up operation
- Prevent air conditioners from being overloaded
- Protect the servers from the risk of overheating
- No need manual controls due to they cover overheat automatically



Operation Scenario

➤ When the number of the indoor units : 2

Let **A** be temperature difference set value,
Let **B** be the difference between the cooling set temp. and the current room temp.

- ① When duty rotation is enabled, IDU #1 is in operation and IDU #2 is on standby.
- ② If B is higher than A, the standby unit starts operation.
- ③ When B goes down and remains below A, the backup unit stops and goes back to standby mode.

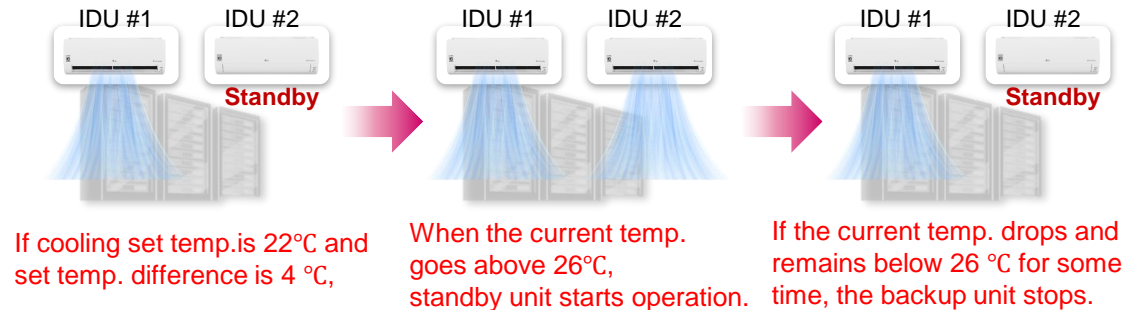

Capacity Back-up Operation

Stable & Reliable Operation

When the difference between the cooling set temp. and the current room temp. is higher than the **set temperature difference of capacity back-up**, the standby unit operates.

Operation Scenario

➤ When the number of the indoor units : 2

Let **A** be temperature difference set value,

Let **B** be the difference between the cooling set temp. and the current room temp.

- ① When duty rotation is enabled, IDU #1 is in operation and IDU #2 is on standby.
- ② If **B** is higher than **A**, the standby unit starts operation.
- ③ When **B** goes down and remains below **A**, the backup unit stops and goes back to standby mode.

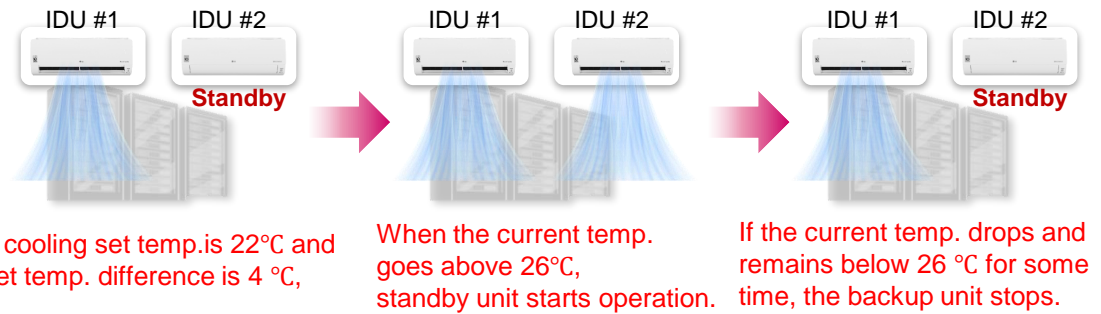

Assume that

Cooling target temp set = 18°C,

Set temperature difference * = 4°C = **A**

For example, when t_2 ,

Temperature difference, **B** = 4°C

= indoor temp. (22°C)

- cooling set temp. (18°C)

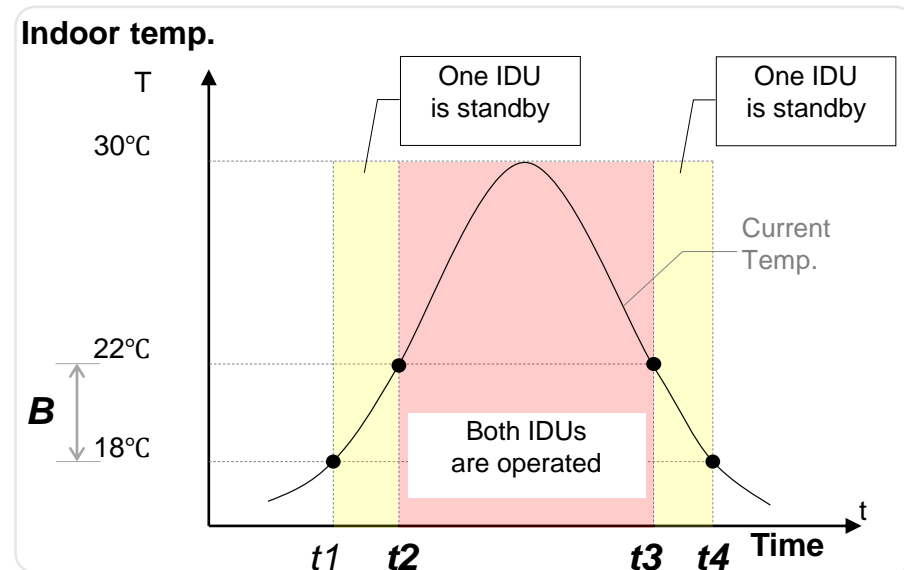

* The available temperature difference setting range is 1°C ~ 6°C

Capacity Back-up Operation

Stable & Reliable Operation

When the difference between the cooling set temp. and the current room temp. is higher than the **set temperature difference of capacity back-up**, the standby unit operates.

Operation Scenario

➤ When the number of the indoor units : 2

The set temperature difference is A, and the difference between the cooling set temp. and the current room temp. is B,

- ① When duty rotation is enabled, IDU #1 is in operation and IDU #2 is on standby.
- ② If B is higher than A, the standby unit starts operation.
- ③ When B goes down and remains below A for some time, the backup unit stops and goes back to standby mode.

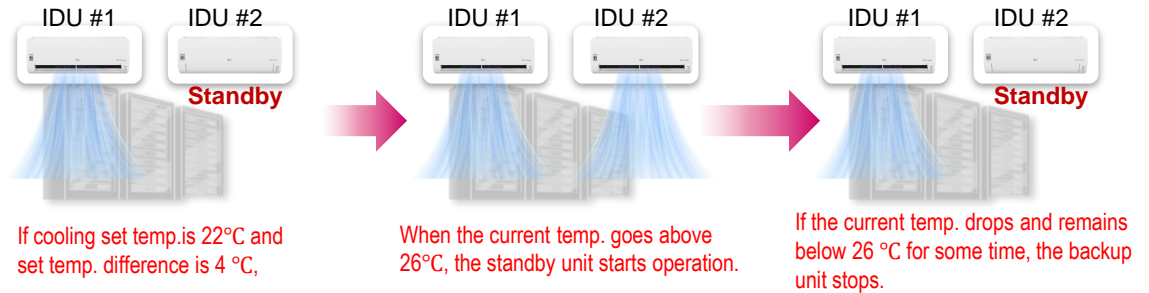

➤ When the number of the indoor units : 3

- ① When duty rotation is enabled, one unit is on standby.
- ② B is higher than A, the standby unit starts operation and all systems are on.
- ③ When B goes down below A, the backup unit stops and goes back to standby mode.

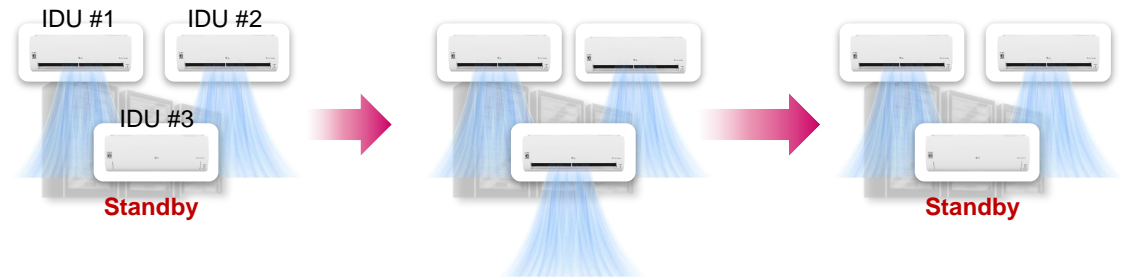

➤ When the number of the indoor units : 4

- ① When duty rotation is enabled, one unit is on standby.
- ② If B is higher than A, the standby unit starts operation and all systems are on.
- ③ When B goes down below A°C, the backup unit stops and goes back to standby mode.

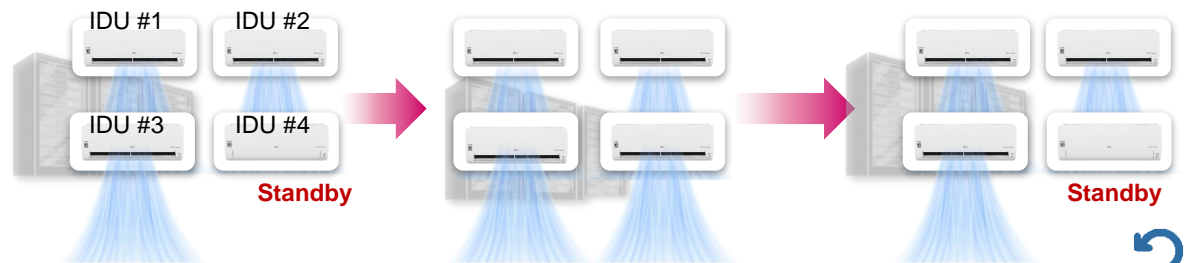

Simple System Compared to Dry Contacts

Easy Installation

For small server room, LG solution has more simple system with only one remote controller. It doesn't need additional control accessories such as dry contacts.

Conventional – Using Dry Contacts

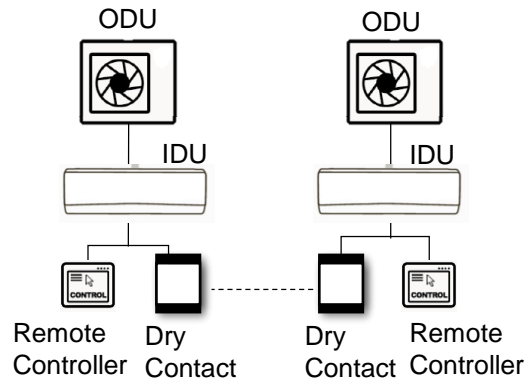

- **Higher product cost :**
Conventional system needs dry contacts or 3rd party control individual remote controller(s).
- **Higher installation cost :**
Need more labor and time for design, installation, cabling and test.
- **Design & Installation difficulties**
It is difficult to make if you need to control multiple indoor units.

LG Small Server Room Cooling Solution

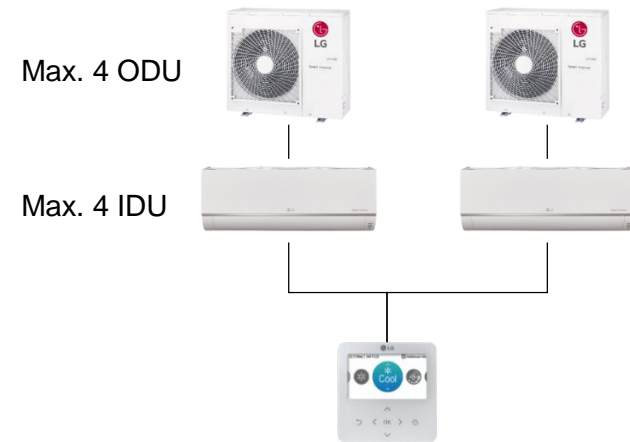

- **Lower product cost**
Only LG remote controller needed for max.4 ODUs and IDUs.
- **Lower installation cost**
Need less labor and time for design, installation, cabling and test.
- **Easy Design & Installation**
It provides easy design and installation because it has simple system with LG controller even in case of several ODUs and IDUs(Max.4).

Simple System Compared to Central Controllers

Easy Installation

Considering a server room solution using central controllers' interlocking + schedule function is **too much expensive and complex** for small sized server rooms.

Using Central Controllers

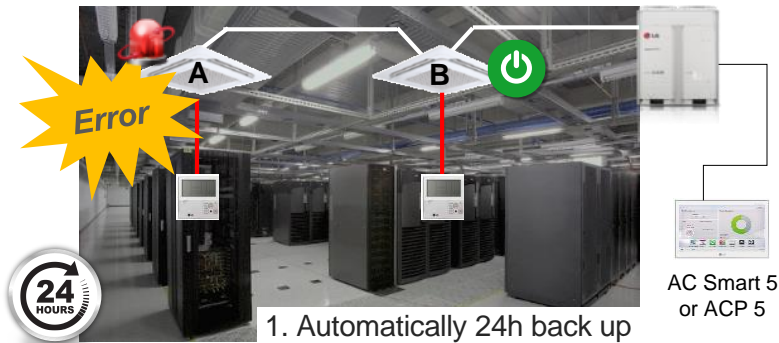

- **Higher product cost :**
Conventional system needs AC Smart 5.
- **Higher installation cost :**
Need the installation of communication lines for central controllers.
- **Design & Installation difficulties**
It is difficult to make and manage the interlocking logics.

Small Server Room Cooling Solution

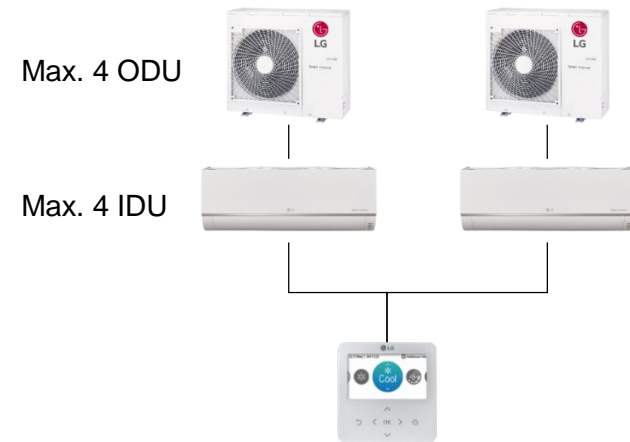

- **Lower product cost**
Only LG remote controller needed for max.4 ODUs and IDUs.
- **Lower installation cost**
Need less labor and time for design, installation, cabling and test.
- **Easy Design & Installation**
It provides easy design and installation because it has simple system with LG controller even in case of several ODUs and IDUs(Max.4).

Differences Compared to Group Control

Installation and Settings

For small server rooms, the standard III remote controller can recognize each indoor unit separately, and can control each indoor unit separately also using central control address of each indoor unit.

Conventional Group Control

Hardware Installation :

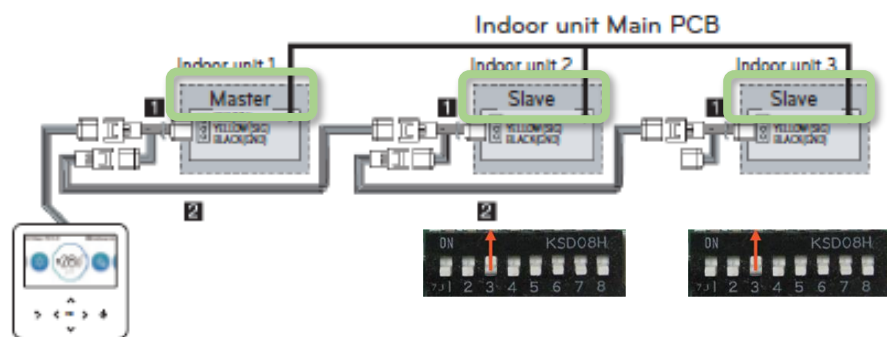

Only 1 indoor unit should be set as Master.

The other indoor units should be set as Slaves.

- Change dip switch setting of slave indoor units

Maximum 16 indoor units can be controlled by 1 remote controller

All indoor units are operating in the same state.

Assume that all IDUs were off. If one of the indoor unit is turned on, the other units will be turned on right after.

1) Applicable Products _ Indoor Units which produced after 1st December 2021.

Standard III remote controller which produced after 15th November. (Software version : 2.11.5a or later)

Server Room Solution

Hardware Installation : same

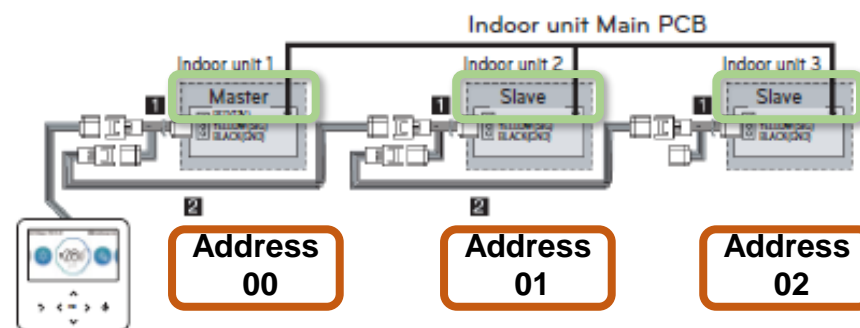

Only 1 indoor unit should be set as Master. : same

The other indoor units should be set as Slaves : same

➤ **Applicable Products¹⁾ : Maximum 4 indoor units can be controlled by 1 remote controller**

➤ **Each indoor unit can operate in various states.**

Each indoor unit is controlled by the standard III due to the logics for server room solution.

Settings Related to the Server Room Solution



Server room configuration on standard III remote controller enables a quickly and easy setting.

➤ Server Room Solution Usage Setting

❶ Click [Server Room] in installer setting mode

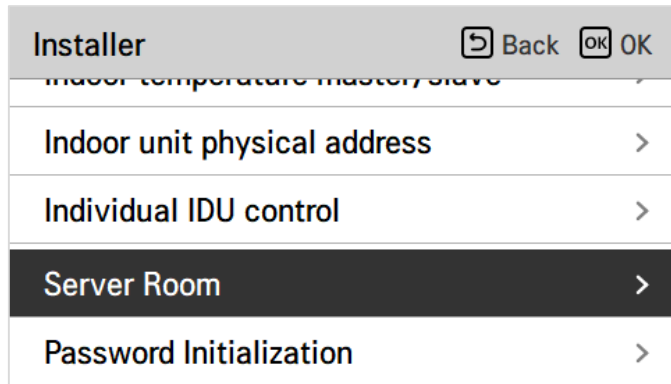

❷ Click [Usage Setting]

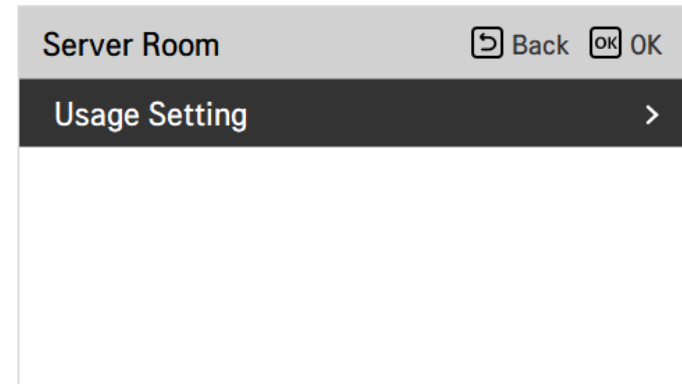

❸ Set [Not Use] / [Use]

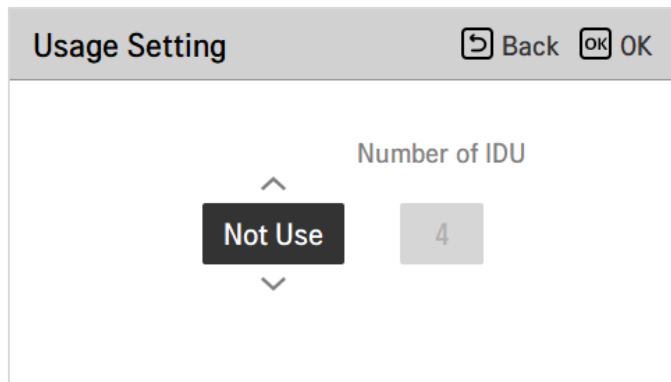

❹ Set the number of indoor units ([2] ~ [4])

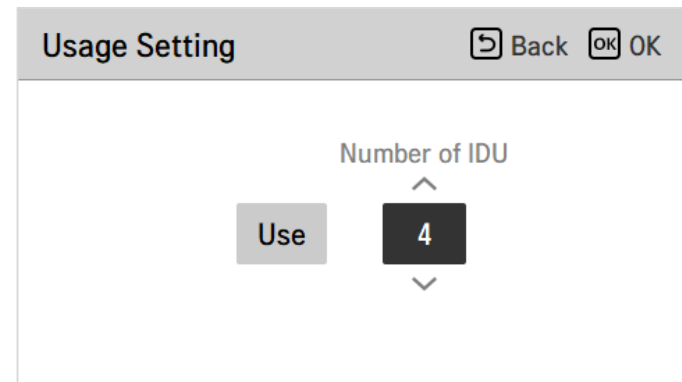

Settings Related to the Server Room Solution



Server room configuration on standard III remote controller enables a quickly and easy setting.

➤ Input the addresses of indoor units

❶ Click [IDU Address]

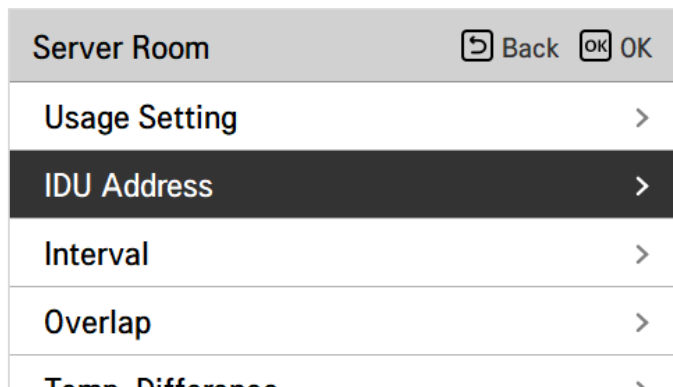

❷ Set indoor unit address

In case of the number of indoor units is 2

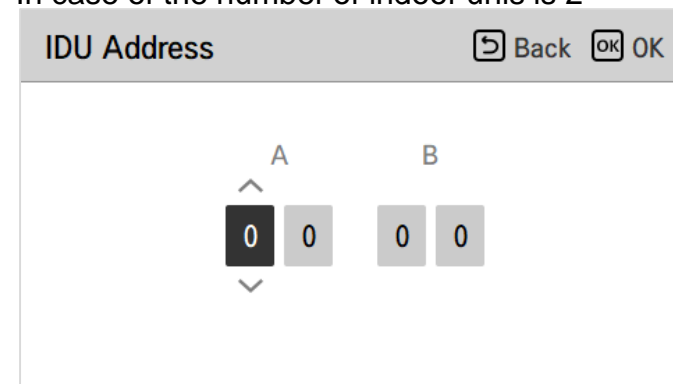

In case of the number of indoor units is 3

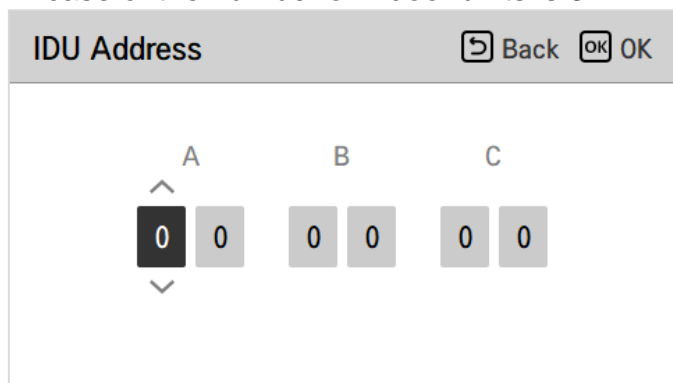

In case of the number of indoor unit is 4



Settings Related to the Server Room Solution



Server room configuration on standard III remote controller enables a quickly and easy setting.

➤ Set the interval and overlap time for duty rotation

❶ Click [Interval]

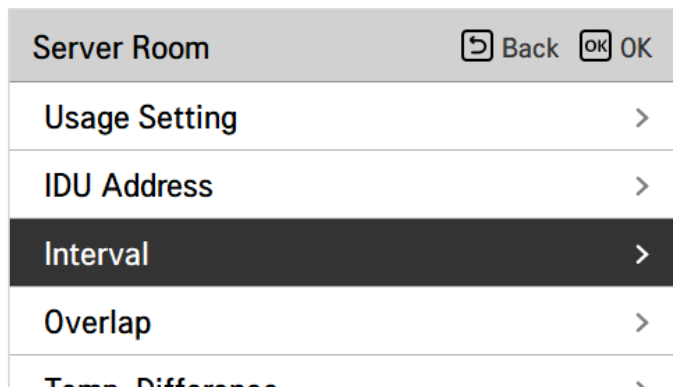

❷ Set interval time between [001] ~ [999] hour(s)
(default : 24 hours)

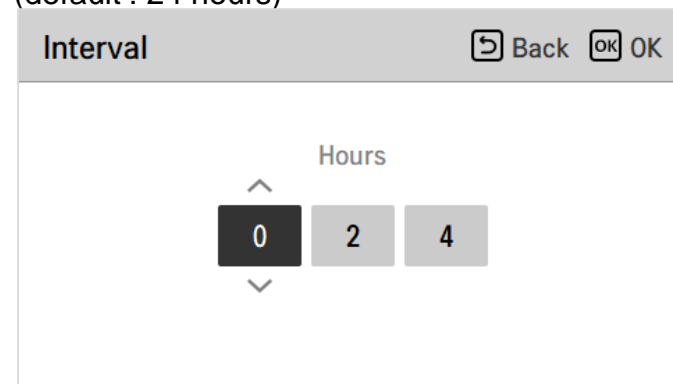

❸ Click [Overlap]

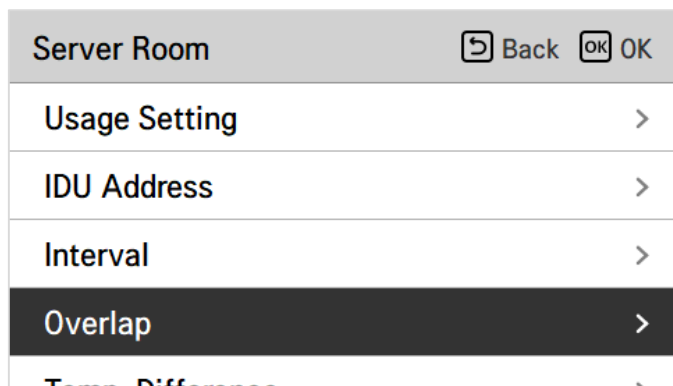

❹ Set overlap time between [1] ~ [59] minute(s)
(default : 10 minutes)

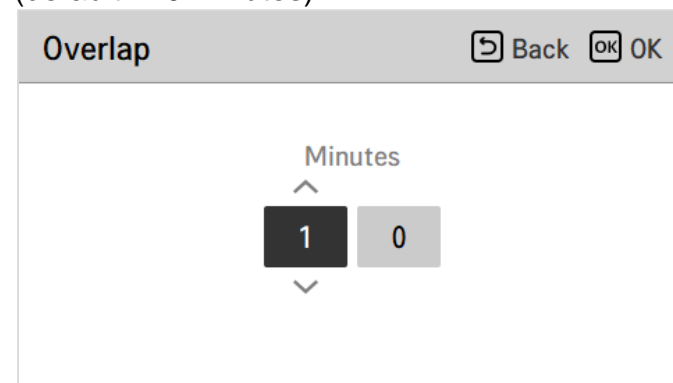

Settings Related to the Server Room Solution

Installation and Settings

Server room configuration on standard III remote controller enables a quickly and easy setting.



➤ Set the temperature difference for duty rotation

❶ Click [Temp. Difference]

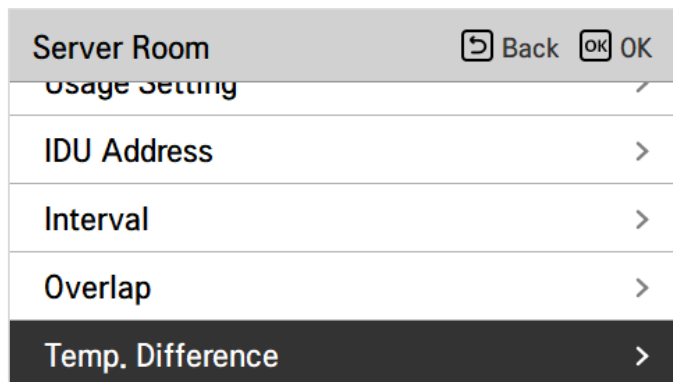

❷ Set interval time between [1] ~ [6] °C (default : 3°C)





1. This document is issued in November 2021, and the validity period is 1 year from the date of issue.
2. The images in this document may differ from the actual product, and the indicated specifications are subject to change without prior notice to improve the appearance and product performance.

Copyright © 2021 by LG HVAC Solutions All rights reserved.

No part of this publication may be reproduced or distributed in any form or by any means, without the prior written permission of the publisher.